

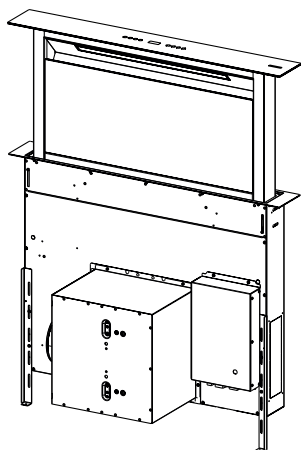



- IT LIBRETTO DI USO
- EN USER MANUAL
- FR MANUEL D'UTILISATION
- DE BEDIENUNGSANLEITUNG
- NL GEBRUIKSAANWIJZING
- ES MANUAL DE USO
- PT LIVRO DE INSTRUÇÕES PARA UTILIZAÇÃO
- RU РУКОВОДСТВО ПО ЭКСПЛУАТАЦИИ
- SV BRUKSANVISNING
- DA BRUGSVEJLEDNING
- PL INSTRUKCJA UŻYTKOWANIA
- NO BRUKSVEILEDNING
- FI KÄYTTÖOHJEET
- AR كتيب تعليمات الاستعمال



*KDD90CNE - KDD90CNE2*  
*KDD60VXE-2 - KDD60VXE-3*  
*KDD90VXE-2 - KDD90VXBE*  
*KDD90VXNE - KDD90VXSE*

## EN 1. SAFETY

### INFORMATION

 For your safety and correct operation of the appliance, read this manual carefully before installation and use. Always keep these instructions with the appliance even if you move or sell it. Users must fully know the operation and safety features of the appliance.

 The wire connection has to be done by specialized technician.

- The manufacturer will not be held liable for any damages resulting from incorrect or improper installation.
- If the instructions for installation of the gas hob specify a greater distance, this must be respected.
- Check that the mains voltage corresponds to that indicated on the rating plate fixed to the inside of the hood.
- Means for disconnection must be incorporated in the fixed wiring in accordance with the wiring rules.
- For Class I appliances, check that the domestic power supply guarantees adequate earthing.
- Connect the extractor to the exhaust flue through a pipe of minimum diameter 120 mm. The route of the flue must be as short as possible.
- Regulations concerning the discharge of air have to be fulfilled.
- Do not connect the extractor hood to exhaust ducts carrying combustion fumes (boilers,

fireplaces, etc.).

- If the extractor is used in conjunction with non-electrical appliances (e.g. gas burning appliances), a sufficient degree of aeration must be guaranteed in the room in order to prevent the backflow of exhaust gas. When the cooker hood is used in conjunction with appliances supplied with energy other than electric, the negative pressure in the room must not exceed 0,04 mbar to prevent fumes being drawn back into the room by the cooker hood.
- The air must not be discharged into a flue that is used for exhausting fumes from appliances burning gas or other fuels.
- If the supply cord is damaged, it must be replaced from the manufacturer or its service agent.
- Connect the plug to a socket complying with current regulations, located in an accessible place.
- With regards to the technical and safety measures to be adopted for fume discharging it is important to closely follow the regulations provided by the local authorities.

 **WARNING:** Before installing the Hood, remove the protective films.

- Use only screws and small parts supplied with the hood.

 **WARNING:** Failure to install the screws or fixing device in accordance with these instructions may result in

electrical hazards.

- Do not look directly at the light through optical devices (binoculars, magnifying glasses...).
- Do not flambè under the range hood; risk of fire.
- This appliance can be used by children aged from 8 years and above and persons with reduced physical, sensory or mental capabilities or lack of experience and knowledge if they have been given supervision or instruction concerning use of the appliance in a safe way and understand the hazards involved. Children shall not play with the appliance. Cleaning and user maintenance shall not be made by children without supervision.
- Children should be supervised to ensure that they do not play with the appliance.
- The appliance is not to be used by persons (including children) with reduced physical, sensory or mental capabilities, or lack of experience and knowledge, unless they have been given supervision or instruction.

 Accessible parts may become hot when used with cooking appliances.

- Clean and/or replace the Filters after the specified time period (Fire hazard). See paragraph Care and Cleaning.
- There shall be adequate ventilation of the room when the range hood

is used at the same time as appliances burning gas or other fuels (not applicable to appliances that only discharge the air back into the room).

- The symbol  on the product or on its packaging indicates that this product may not be treated as household waste. Instead it shall be handed over to the applicable collection point for the recycling of electrical and electronic equipment. By ensuring this product is disposed of correctly, you will help prevent potential negative consequences for the environment and human health, which could otherwise be caused by inappropriate waste handling of this product. For more detailed information about recycling of this product, please contact your local city office, your household waste disposal service or the shop where you purchased the product.

- This suction Hood can be used in combination with a Gas hob with the following characteristics:
- Total maximum power 12.4kW.
- 5 burners as shown in the figure.

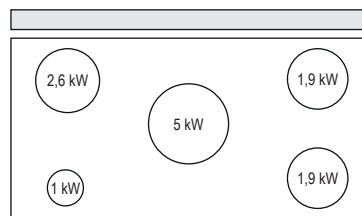

- Total maximum power 11,5kW.

- 5 burners as shown in the figure.

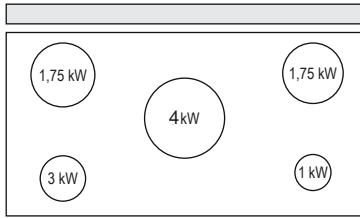

- Total maximum power 17,7kW.
- 5 burners as shown in the figure.

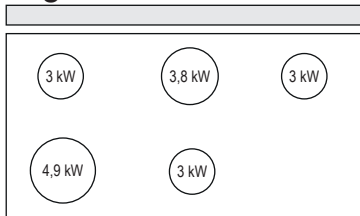

- Total maximum power 16,6kW.
- 4 burners as shown in the figure.

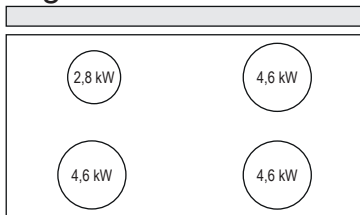

## Extending/retracting the appliance

### Risk of injury!



Risk of jamming when retracting and extending the appliance. Never reach into the moving area of the appliance while it is being retracted or extended. Keep children at a safe distance.

## 2. USE

- The extractor hood has been designed exclusively for domestic use to eliminate kitchen smells.
- Never use the hood for purposes other than those for which it has been designed.
- Never leave high naked flames under the hood when it is in operation.
- Adjust the flame intensity to direct it onto the bottom of the pan only, making sure that it does not engulf the sides.
- Deep fat fryers must be continuously monitored during use: overheated oil can burst into flames.

## 3. CARE AND CLEANING

- The sponge-like part of the filter can be washed in the dishwasher at least once every 4 months, or more frequently if use is particularly intense. Operation is guaranteed for up to a maximum of 5 washes, after which it must be replaced (W).

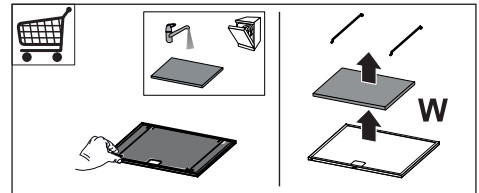



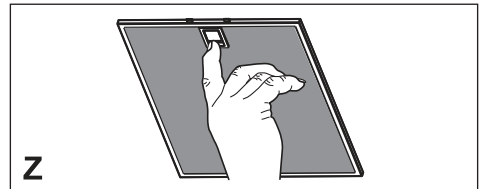

- The Grease filters must be cleaned every 2 months of operation, or more frequently for particularly heavy usage, and can be washed in a dishwasher (Z).



- Clean the hood using a damp cloth and a neutral liquid detergent.

## 4. CONTROLS

Button	Function	LED button
		
A	<p>The button only works when the door is open. Turns the motor On/Off at speed one.</p> <p>Press and hold the button for approximately 5 seconds, with all the loads turned off (Motor and Lights), to turn the Remote control On/Off.</p>	- IR+Dot (Flashes twice)-Remote control On. IR+Dot (Flashes once)-Remote control Off.
B	<p>Press Briefly = Turns the Lights On/Off at maximum intensity.</p> <p>Press and hold for 2 Seconds = Turns the Courtesy Lights On/Off.</p>	- -
C	<p>The button only works when the door is open. Activates / Deactivates the 24h function which turns the motor on at speed one for 10 minutes every hour, for 24 hours. At the end of this time the hood turns Off.</p>	Visualizza un'animazione. 
D	<p>Only works with the Door Open = decreases the operating speed. Speeds P1 - P2 are the 2 intensive speeds, which are set to: P1 = 5 minutes and P2 = 7 minutes At the end of this time the motor returns to speed two.</p>	Displays the set speed: P2 - P1 - 3 - 2 - 1
E	<p>Only works with the Door Open = increases the operating speed. Speeds P1 - P2 are the 2 intensive speeds, which are set to: P1 = 5 minutes and P2 = 7 minutes At the end of this time the motor returns to speed two.</p> <p>Works both with the Door Closed and Open. Press and hold for 2 Seconds = Enables/Disables the Activated Charcoal Filter Alarm with the Motor turned off and no Filter Alarm triggered.</p>	Displays the set speed: 1 - 2 - 3 - P1 - P2 C flashes twice = A.C. Filter Alarm Activated C flashes once = A.C. Filter Alarm Deactivated
F	<p>Only works with the Door Open. Activates/Deactivates the Delay, automatic switch-off of the motor with a 15' delay. When this function is activated the motor is set to speed one. If the function is deactivated before the time foreseen, the motor will remain at speed one.</p>	Displays L
G	<p>Works both with the Door Closed and Open. Press and hold for 2 Seconds = With the filter alarm triggered the Filter Alarm is Reset. These indications are only visible when the motor is turned off.</p>	Displays  Indicates the need to wash the metal grease filters. The alarm is triggered after the Hood has been in operation for 100 working hours. Displays  Indicates the need to change the activated charcoal filters, and also to wash the metal grease filters. The alarm is triggered after the Hood has been in operation for 200 working hours.
H	<p>Door Closed Opens the door and Motor + Lights = On.</p> <p>Door Open Closes the door and Motor + Lights = Off</p>	- -

## 5. REMOTE CONTROL (OPTIONAL)



## 6. LIGHTING

- For replacement contact technical support ("To purchase contact technical support").

