

PRECAUTIONS	24	Using the hob	32
General safety instructions	24	Additional functions	34
Installation	27	Special functions	36
Appliance purpose	28	User menu	37
This user manual	28	Safety features	38
Manufacturer's liability	28	Error notifications	39
Identification plate	28	CLEANING AND MAINTENANCE	39
Disposal	29	Cleaning the glass ceramic hob	39
To save energy	29	What to do if...	40
Information on power consumption in off/stand-by mode	29	INSTALLATION	40
How to read the user manual	29	Electrical connection	40
DESCRIPTION	30	Power limitation procedure	41
Control panel	30	Section cut from the countertop	41
USE	31	Mounting	42
Preliminary operations	31	Fastening to the built-in cabinet	43
Basic functions	32	Instructions for the installer	43

We advise you to read this manual carefully, which contains all the instructions for maintaining the appliance's aesthetic and functional qualities. For further information on the product: www.smeg.com

PRECAUTIONS

General safety instructions

Risk of personal injury

- During use the appliance and its accessible parts become very hot. Keep children well away from the appliance.
- Protect hands with heat resistant gloves during use.
- Never try to put out a fire or flames with water: Turn off the appliance and smother the flames with a fire blanket or other appropriate cover.
- This appliance may only be used by children aged 8 years and over, and by people of reduced physical, sensory or mental capacity, or lacking in experience in the use of electrical appliances, provided that they are supervised or have been given instructions on the safe use of the appliance and of the hazards associated with it.
- Children must not play with the appliance.
- Keep children under the age of eight at a safe distance unless they are constantly supervised.
- Keep children under the age of 8 away from the appliance when it is in use.
- Cleaning and maintenance must not be carried out by unsupervised children.
- Be aware of how rapidly the cooking zones heat up. Do not place empty pans on the heat.

- Danger of overheating.
- Activate the controls lock when you have children or pets which could reach the hob.
 - Do not touch or clean the hob surface during operation or when the residual heat indicator lights are still on.
 - After use, switch off the plates. Never rely solely on the cookware detector.
 - Supervise children carefully as they cannot readily see the residual heat indication. After use the cooking zones remain hot for a certain period of time even if they have been turned off. Keep children away from the cooking zones.
 - The cooking process must always kept under control. A short cooking process must be continuously monitored.
 - **WARNING:** Cooking foods containing fat and/or oil without monitoring them can be dangerous and can cause a fire.
 - Fats and oils can catch fire if they overheat. Do not leave the appliance unattended while preparing foods containing oils or fats. If fats or oils catch fire, never put water on them. Place the lid on the pan and turn off the relevant cooking zone.
 - Do not use the Booster and/or the Double Booster functions (if present) to heat fats or oils. Fire hazard.
 - Do not place metal objects, such as dishes or cutlery, on the surface of the hob during cooking as they may overheat.
 - Do not cook foods in closed tins or containers or plastic containers.
 - Do not use magnetic tins.
 - Do not use trivets or other items between the bottom of the pan and the glass ceramic surface. Danger of burns.
 - Do not insert pointed metal objects (cutlery or utensils) into the slots in the appliance.
 - Do not use or store flammable materials near the appliance or directly underneath the hob.
 - Switch off the appliance immediately after use.
 - Do not pull the cable to unplug the appliance (if present).
 - **DO NOT USE AEROSOLS IN THE VICINITY OF THIS APPLIANCE WHILST IT IS IN USE.**
 - **DO NOT MODIFY THIS APPLIANCE.**
 - Always wear personal protective equipment (PPE) before carrying out any work on the appliance (installation, maintenance, positioning or moving).
 - Do not clean the appliance if it is still hot or in operation.
 - After use the cooking zones remain hot for a certain period

of time after they have been turned off. Do not touch the hob surfaces.

- Before performing any work on the appliance, switch off the power supply.
- Do not try to repair the appliance yourself or without the assistance of a qualified technician.
- If the power cable becomes damaged, contact technical support immediately to arrange for it to be replaced in order to avoid possible hazards.
- If cracks or fissures form, or if the glass ceramic cooking surface breaks, turn off the appliance immediately. Disconnect the power supply and call Technical Support.
- People who have pacemakers or other similar devices fitted must make sure that the operation of these devices is not affected by the induction field, the frequency range of which is between 20 and 50 kHz.
- In conformity with the provisions regarding electromagnetic compatibility, the electromagnetic induction cooking hob comes under group 2 and class B (EN 55011).

Risk of damaging the appliance

- Do not use abrasive or

corrosive detergents (e.g. scouring powders, stain removers and metallic sponges) on glass parts.

- Use wooden or plastic utensils.
- Do not sit on the appliance.
- Do not use the glass ceramic cooking surface as a support surface.
- Do not use the appliance as a support surface.
- Do not obstruct ventilation openings and heat dispersal slots.
- Do not use the hob if the pyrolytic cycle is taking place inside any oven installed below.
- Do not use steam jets to clean the appliance.
- Never leave the appliance unattended during cooking operations where fats or oils could be released, as these could then heat up and catch fire. Be very careful.
- Fire hazard: Never leave objects on the cooking surfaces.
- DO NOT FOR ANY REASON USE THE APPLIANCE AS A SPACE HEATER.
- Cooking vessels or griddle plates should be placed inside the perimeter of the hob.
- All pans must have smooth, flat bottoms.
- If any liquid does boil over or spill, remove the excess from

the hob.

- Take care not to spill acid substances such as lemon juice or vinegar on the hob.
- Do not spill sugar or sweet mixtures on the hob during cooking.
- Do not place materials or substances that could melt or catch fire (paper, plastic or aluminium foil) on the appliance while it is in use.
- Place the cookware directly on the glass ceramic surface.
- Do not put empty pans or frying pans on switched on cooking zones.
- Do not use rough or abrasive materials or sharp metal scrapers.
- The glass ceramic surface is highly resistant to impact. However, prevent hard, solid objects from falling on the cooking surface as they may cause it to break.
- Do not use cleaning products containing chlorine, ammonia or bleach on parts made of steel or that have metallic surface finishes (e.g. anodizing, nickel- or chromium-plating).
- This appliance is not intended to be operated by means of external timer or separate remote control system.
- To prevent scratching the glass surface, avoid sliding pots across it. Lift them and place

them gently where needed instead.

Installation

- THIS APPLIANCE **MUST NOT BE INSTALLED** IN BOATS OR CARAVANS.
- Position the appliance into the cabinet cut-out with the help of a second person.
- Check that the carcass has the required openings.
- Check that the carcass material is heat resistant.
- Installation and servicing should be carried out by qualified personnel in accordance with current standards.
- Have the electrical connection performed by authorised technical personnel.
- The appliance must be connected to earth in compliance with electrical system safety standards.
- Use cables that can withstand temperatures of at least 90°C.
- Run the power cable in the rear part of the unit. Make sure that it does not come into contact with the lower part of the hob or a built-in oven below it.
- Be careful when connecting additional electrical appliances. Connection cables must not come into contact with hot cooking zones.
- The tightening torque of the screws of the terminal supply wires must be 1.5 - 2 Nm.

- Do not attach the appliance too tightly to the unit as this could cause damage during use or partially obstruct the heat dispersal slots.
- The power cable must only be installed or replaced by a qualified technician.
- If the power cable becomes damaged, contact technical support immediately to arrange for it to be replaced in order to avoid possible hazards.
- Always use any necessary/required personal protective equipment (PPE) before performing any work on the appliance (installation, maintenance, positioning or movement).
- Before performing any work on the appliance, switch off the power supply.
- Allow the appliance to be disconnected after installation, via an accessible plug or a switch in the case of a fixed connection.
- Fit the power line with an all-pole circuit breaker with a contact separation distance sufficient to provide complete disconnection in category III overvoltage conditions, pursuant to installation regulations.
- This appliance can be used up to a maximum altitude of 2,000 metres above sea level.

- Do not set the hob at a power higher than that supported by the electrical system.

Appliance purpose

This appliance is intended for cooking food in the home environment. Every other use is considered inappropriate. It cannot be used:

- in employee kitchens, shops, offices and other working environments.
- in farms/farmhouses.
- by guests in hotels, motels and residential environments.
- In bed and breakfast accommodation.

This user manual

- This user manual is an integral part of the appliance and must therefore be kept in its entirety and within the user's reach for the whole working life of the appliance.
- Read this user manual carefully before using the appliance.
- The explanations in this manual include images, which describe all that regularly appears on the display. However, it should be kept in mind that the appliance may be equipped with an updated version of the system, and as such, all that appears on the display may differ from those in the manual.

Manufacturer's liability

The manufacturer declines all liability for damage to persons or property caused by:

- use of the appliance other than that specified;
- failure to comply with the instructions in the user manual;
- tampering with any part of the appliance;
- use of non-original spare parts.

Identification plate

The identification plate bears the technical data, serial number and brand name of the appliance. Do not remove the identification

plate for any reason.

Disposal



This appliance conforms to the WEEE European directive (2012/19/EU) and must be disposed of separately from other waste at the end of its service life.

The appliance does not contain substances in quantities sufficient to be considered hazardous to health and the environment, in accordance with current European directives.



Power voltage Danger of electrocution

- Disconnect the mains power supply.
- Unplug the appliance.

To dispose of the appliance:

- Cut the power cable and remove it.
- Deliver the appliance to the appropriate recycling centre for electrical and electronic equipment waste, or return it to the retailer when purchasing an equivalent product, on a one for one basis.

Our appliances are packaged in non-polluting and recyclable materials.

- Deliver the packing materials to the appropriate recycling centre.



Plastic packaging Danger of suffocation

- Do not leave the packaging or any part of it unattended.
- Do not let children play with the plastic bags.

To save energy

- The diameter of the base of the pan must not extend beyond the lines printed on the glass ceramic surface.
- Pans must not be placed outside the perimeter of the hob or on the display.
- When buying a pan, check whether the diameter indicated is that of the base or the top of the pan, as the top is almost always larger than the base.
- When preparing dishes with long cooking times, you can save time and energy by using a pressure cooker, which also helps to retain vitamins contained in the food.
- Make sure that the pressure cooker contains enough liquid as, if there is not enough and

it overheats, this may cause damage to both the pressure cooker and the cooking zone.

- If possible, always cover pans with a suitable lid.
- Choose a pan suitable for the quantity of food to be cooked. A large, half-empty saucepan leads to a waste of energy.



Under certain circumstances, if the hob and the oven are used at the same time, the maximum power limit of the electrical system might be exceeded.

Information on power consumption in off/stand-by mode

Technical data on the appliance's power consumption in off/stand-by mode can be found at www.smeg.com under the page corresponding to the product in question.

How to read the user manual

This user manual uses the following reading conventions:



Warning/Caution



Information/Advice

DESCRIPTION

General description

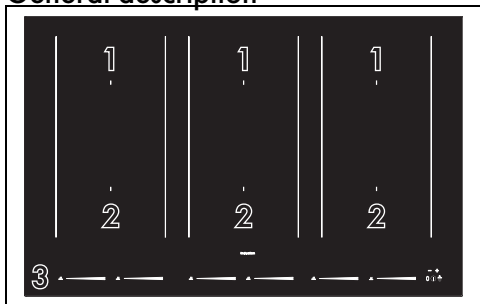

- 1,2: Induction cooking zones
- 3: Control panel.

Zone	Dimensions H x L (mm)	Max. power draw (W)*	Power draw in booster function (W) *	Power draw in Double Booster function (W)*
1 - 2 Single zones	182 x 200	2100	2500	3000
1 + 2 Bridge function	365 x 200	3000	3700	-

*Power levels are approximate and may vary according to the pan used or the settings made.

Control panel

Cooking zones area



List of buttons



Scroll bar: increases or decreases the power level of a cooking zone.

|| Warming function button: activates the keep warm function.

List of icons

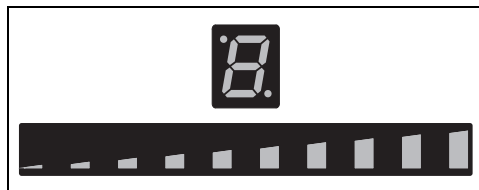

Scroll bar and cooking: zone display: indicate the power level that has been selected for a cooking zone.

SS Warming function icon: indicates the activation of the keep warm function.

—| Key icon: indicates the activation of the controls lock function.

 Clock icon: indicates the timing of a cooking zone.

 Bridge function icons: indicate the activation of the Bridge function.

Main controls area



 On/Off button: turns the hob on or off.



 Auto-Vent 2.0 function button: activates communication between the hob and the extractor hood (on some models only).

 Grill function button: activates the Grill function.

 Increase and decrease buttons.

 Minute minder timer icon: indicates the activation of the independent minute minder timer.

 Timer display.

 If there is no  symbol, it means that the appliance is not designed for wireless communication with the hood.

Advantages of induction cooking



The appliance is equipped with an induction generator for each cooking zone. Each generator located under the glass ceramic cooking surface creates an electromagnetic field which induces a thermal current in the base of the pan. This means the heat is no longer transmitted from the hob to the pan but created directly inside the pan by the inductive current.

- Energy saving thanks to the direct transmission of energy to the pan (suitable magnetisable cookware is required) compared to traditional electric cooking.
- Improved safety as the energy is only transmitted to the pan placed on the hob.
- High level of energy transmitted from the induction cooking zone to the base of the pan.
- Rapid heating speed.
- Reduced danger of burns as the cooking surface is only heated under the base of the pan; foods which overflow do not stick.

Power control

The hob is fitted with a power control module that optimises/limits consumption. If the overall set power level exceeds the maximum limit permitted, the electronic circuit board will automatically manage the power supplied by the hot plates. The module tries to maintain the maximum deliverable power levels. Levels set by the automatic control will appear on the display.



Priority is given to the last zone set.



The power control module does not affect the total power consumption of the appliance.

USE

Preliminary operations



See General safety instructions.

- Remove any protective film from the outside or inside of the appliance, including any accessories (if present).

- Remove any labels (apart from the technical data plate).

Cookware suitable for use in induction cooking

Cookware used on the induction cooking surface must be made of metal, with magnetic properties and a sufficiently large base.

Suitable cookware:

- Enamelled steel cookware with thick bases.
- Cast iron cookware with an enamelled base.
- Cookware in multilayer stainless steel, ferritic stainless steel and aluminium with a special base.

Unsuitable cookware:

- Copper, stainless steel, aluminium, fireproof glass, wood, ceramic and terracotta cookware.

Cookware diameters

To ensure that the appliance detects the containers correctly and for best results, use the pan sizes indicated in the following table.

Cooking zones	Minimum diameter (mm)	Recommended diameter (mm)
1 - 2 (Single)	90 - 110	160 - 180
1 - 2 (Bridge)	190 - 230	200

Bear in mind the following:



- Pans should not extend beyond the lines marked on the surface of the appliance.
- Do not place pans near to the edges of the glass ceramic surface or close to the control panel.
- If you use a griddle, it must have a maximum size of and 36 x 24 cm for zones 1 - 2 and 36 x 20 cm for zones 3 - 4.
- Do not use a griddle on zones 5 and 6.

Basic functions

First power connection

When connected to the power supply for the first time, or after power has been switched back on after a power failure, an automatic check is carried out that control turns on the indicator lights and the displays for a few seconds. Afterwards, the appliance can be used normally.

Switching on and off

Press and hold the  button for at least one second to switch on the appliance. To turn off the appliance, press the  button until a sound is emitted. The appliance will switch off automatically after about 10 seconds of inactivity.

Using the hob

Switching on the cooking zones



The appliance is fitted with an automatic pan sensing system.

After switching on the display:

1. Position a pan (suitable for induction cooking and not empty) on the cooking zone you wish to use.
2. The display corresponding to the zone on which the container has been placed turns on automatically and displays .

Adjusting cooking zones

After having placed a pan on the cooking zone and made sure that the zone has been activated:

1. Place a finger on the left-hand side of the scroll bar of the cooking zone to be used.



The power level is now .

2. Move your finger to the left or right to select the power level from 1 to 9 or enable the Booster or Double Booster function (see specific sections).

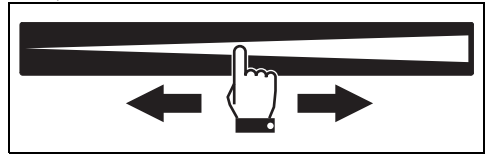

The display of the zone being used will indicate the selected power level.



The power level can also be selected by pressing the scroll bar at the point that corresponds to the required power level.

Switching off the cooking zones

1. Move your finger to the far left of the scroll bar of the cooking zone you wish to turn off.

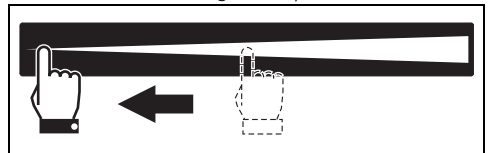

1. The display of the zone selected indicates



To switch off more than one cooking zone at the same time, simply switch off the appliance using the **1** button.

Summary table of power levels

The power can be adjusted to various levels. The table below shows the levels suitable for various types of cooking.

Power level	Suitable for:
0	OFF setting
1 to 2	Cooking small quantities of food (minimum power)
3 to 4	Cooking
5 to 6	Cooking large quantities of food, roasting larger portions
7 to 8	Roasting, slow frying with flour
9	Roasting



Bringing large quantities of water to a boil (maximum power, see "Booster function")

Booster function



See General safety instructions.

The Booster function allows you to heat a pan at maximum power for a limited amount of time. It can be used to bring a large amount of water to the boil rapidly.

After switching on the hob and having selected a zone:

1. Swipe your finger from the far left to the far right of the scroll bar.



The Booster function can also be activated by a pressing the right end of the scroll bar once.

2. The Booster function will be activated and the **P** symbol appears on the cooking zone display.



The Booster function remains active for a maximum of 5 minutes, after which the power level of the zone returns to 9.

To deactivate the Booster function, simply decrease the power level of the cooking zone or switch off the appliance.

Double Booster Function



See General safety instructions.

The Double Booster function allows more power to be supplied compared to the Booster function.

After having activated the Booster function for a cooking zone, press the far right of the scroll bar again. The symbols **|||** and **P** will be displayed in sequence to indicate that the Double Booster function is on.

To deactivate the function, simply select any other power level or switch off the appliance.

Bridge function (on some zones only)



This function automatically divides the power equally between both zones that are in use.

This function allows you to operate two cooking zones (front and rear) at the same time when using pans such as fish kettles or long pans.

After switching on the hob:

1. Place two small pans or one long pan on the vertically connected zones.
2. The displays of the cooking zones involved indicate **0**.
3. The flashing **n** and **U** symbols appear at the side of the displays. These symbols indicate that the Bridge function can be activated.

To activate the Bridge function:

1. Touch the scroll bars of the relevant zones at the same time. The **n** and **U** symbols stop flashing.
2. Once the function has been activated, only the left hand side zone display remains active.

- Use the left-hand side scroll bar to set the required cooking power for both zones.



It is not possible to activate the Double Booster function for the cooking zones on which the Bridge function is active.

If a large, oval or oblong pan is being used, make sure that it is placed in the centre of the cooking zone.

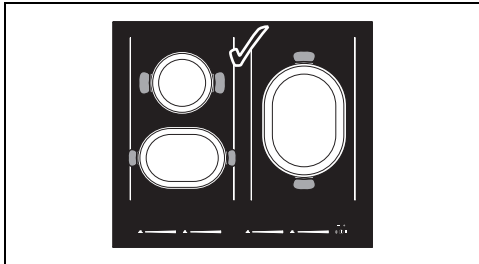

Correct pan position

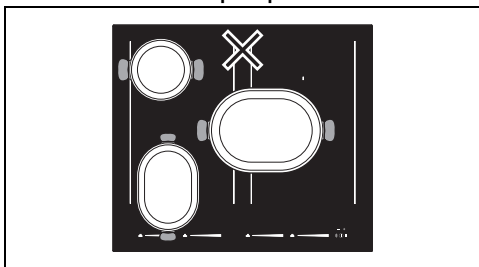

INCORRECT pan position

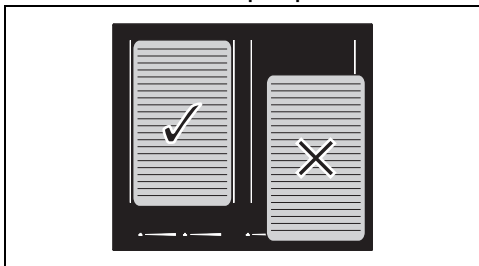

Examples of griddle position

Additional functions

Independent minute minder timer



A maximum of 1 hour and 59 minutes can be set.

This function is used to set a timer that will emit a sound at the end of the set time. It does not stop the operation of the cooking zones but informs the user when the set minutes have elapsed.

After having switched on the hob, without

having activated a cooking zone:

- Press the and buttons at the same time. The icon will appear between them.
- The timer display shows .
- Use the and buttons to select the required time; hold the buttons down to advance more quickly.
- After a few seconds, the timer will start the countdown and the dot between the first and second digit will start to flash.
- When the time elapses, a series of beeps will sound. Press the or button to deactivate the buzzer.

Modifying and deactivating the minute minder timer

To modify or deactivate the timer during the countdown:

- Press the button to activate the hob (if it is off or in stand-by).
- Press the and buttons together.
- Use the and buttons to modify the countdown or reset the timer. The timer has to be turned off in order to reset it.

Increasing and decreasing the minute minder timer (touch by touch)

	-	+
from 0 to 5 minutes	10 sec.	1 minute
from 5 to 9 minutes	30 sec.	1 minute
9 minutes and upwards	1 minute	1 minute

Increasing and decreasing the minute minder timer (fast advance).

	-	+
from 0 to 10 minutes	1 minute	1 minute
from 10 min. to 1 hour	5 minutes	5 minutes
from 1 hour to 1 hour and 59 minutes	5 minutes	5 minutes



With a time of 10 minutes or more, the **min** icon appears below the timer display.

Timed cooking



A maximum of 1 hour and 59 minutes can be set.

This function is used to program the automatic switch-off of each cooking zone at the end of a period of time set by the user.

1. Place a pan on a cooking zone and select a power level.
2. Press the **-** and **+** buttons at the same time. The **⏰** icon appears next to the cooking zone display.
3. Use the **-** and **+** buttons to select the required time; press and hold to advance more quickly.
4. Timed cooking will start a few seconds after the last selection.

5. When the time elapses, a series of beeps will sound. Press the **-** or **+** button to deactivate the buzzer.



- This function can be activated on multiple cooking zones at the same time.
- When the timer of another cooking zone is activated, the **⏰** icon of the previously selected zone will dim slightly.

Modifying or deactivating timed cooking

To modify or reset timed cooking, simply follow the same instructions for modifying or resetting the minute minder timer. If several timed cooking functions have been set, press the **-** and **+** buttons at the same time to move between the timers of each zone and modify them one by one.

Each selected timer is indicated by the **⏰** icon at full brightness, while the other icons are partially dimmed.



An independent timer can always be set during one or several timed cooking functions.

Rapid heating



This function is not available for power the Warming, Booster and Double Booster functions.

This function heats a cooking zone to the maximum and allows it to reach the heat corresponding to the selected power level more quickly.

After selecting a cooking zone:

1. Press and hold the scroll bar at the required power level (1 to 9) for at least 3 seconds.
2. The **R** symbol appears on the display of the zone alternating with the selected power level.
3. After the heating time has elapsed, the cooking zone reverts to the previously selected power level.



This function can be deactivated by selecting and a different power level or by switching the appliance off.

Pause function (on some models only)

This function allows you to pause the operation



of all the cooking zones.

To activate the Pause function:

1. With at least one cooking zone active, press the  and  buttons at the same time.
2.  appears on the displays of all the cooking zones.

 The Pause function can be maintained for a maximum of 10 minutes, after which the appliance switches off.

To deactivate the Pause function:

1. Press the  and  buttons together. An animation appears on the rear right zone scroll bar.
2. Move your finger from left to right on the scroll bar.
3. The Pause function has now been deactivated and the previously set functions are restored.





 The cooking time limitation, the residual heat indicators and the Controls Lock function remain enabled during the Pause function.

Recall Function (on some models only)

 This function can only be used if at least one cooking zone was active at the time of the unintentional switch-off.

This is used to restore some functions that have already been started after the appliance has been switched off unintentionally.

In this case, carry out the following procedure within 6 seconds:

1. Switch on the appliance.
 - The LEDs above the  and  buttons start to flash.
2. Press the  and  buttons at the same time to restore the functions that were previously active.

The Recall function only allows the following functions to be restored:

- 1 Functions and power levels of the cooking zones.
- 2 Timed cooking.
- 3 Bridge Function.
- 4 Rapid heating.
- 5 Booster and Double Booster Functions.

6 Controls lock.

 Any functions not listed will not be restored.



Special functions

Warming Function

 This function allows you to keep cooked food warm or to keep water on the boil.

To activate the Warming function, first turn on the hob, then:

1. Place a pan on a cooking zone.
2. Press the  button to activate the function.

The  symbol appears on the display of the selected cooking zone and the  icon will appear next to the scroll bar.



To turn off the Warming function, simply press the  button of the relative zone again.

Grill Function

 This function is used to activate the Bridge function automatically for the right zones only. It is used when using a griddle or cooking with long pans.

To activate the Grill function:

1. Place a griddle or a long pan on the right zones.
2. Press the  button. The LED above it will flash.

The  symbol appears on the front zone display and the  symbol appears on the rear zone display. The electronics will automatically set the power level to 9 (preheating phase).



After 3 minutes of operation, the power will be lowered to level 7 and the LED above the Grill function button becomes steady.

Use the scroll bar to modify the power level at any time.

Press the  button to deactivate the Grill function.

Auto-Vent 2.0 function (on some models only)



- This function allows you to control the speed of the hood extractor fan via a wireless connection.
- The hood must be designed to use the Auto-Vent 2.0 function.
- The connection is always one way, from the hob to the hood. It is not possible to control the hob via the hood.

The Auto-Vent 2.0 function is disabled by default, but can be enabled from the user menu. This function has an automatic and a manual mode:

- Automatic mode adjusts the hood extractor fan speed according to the total power of the appliance (see "User menu - option U2).
- Manual mode allows you to adjust the extractor fan speed by pressing the  button.

After switching on the hob, to activate manual mode:

1. Press the .
2. Each subsequent press of the button increases the hood fan speed according to a cyclic sequence with 5 levels of adjustment, from 0 (off) to 4 (maximum speed).



To go back to automatic mode, the appliance has to be switched off and on again.



Refer to the hood manual for more detailed information.

User menu

The user menu allows you to modify some operating characteristics of the appliance. There are 4 options available. Each option is marked with the letter "U" together with a progressive number on the timer display.

Option	Description
	Power limitation (kW) - Modification restricted to the installer
	Activation and deactivation of the Auto-Vent 2.0 function (on some models only)
	Auto-Vent 2.0 configuration in automatic mode (on some models only)





Option

Description



Option restricted

Accessing the user menu

1. If the hob is off, switch it on using the  button.
2. Press  again within 3 seconds to switch it off; the  icon starts to flash.
3. Press the  and  buttons at the same time until the graph bars appear above the scroll bars of the right zones.
4. Press the centre of both scroll bars at the same time to complete the access procedure.

User options

Once you have accessed the user menu, the first option that appears is the power limitation option (option U0), which should only be modified by the installer (see "Power limitation procedure").

Use the  and  buttons to move between the options.

To select the values for each option, press the left half of the scroll bar to scroll backwards and the right half to scroll forwards.

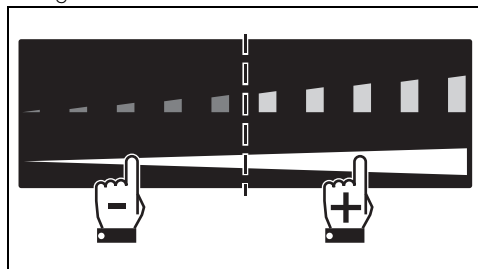

Option U1 (on some models only) allows you to activate or deactivate the Auto-Vent 2.0 function:

- 0: function off.
- 1: function on.

Option U2 (on some models only) allows you to configure the Auto-Vent 2.0 function in automatic mode. 8 values can be selected. The following table shows a summary of the possible

settings:

Hardness level	Hood lighting	Hood fan speed		
		Delicate cooking	Medium cooking	Intense cooking
0	Off		Off	
1	On		Off	
2 - 4 - 6	On	Off	speed 1	speed 2
3 - 5 - 7	On	speed 1	Speed 2	Speed 3

Refer to the table below to select the most suitable value according to the power limitation of the appliance:

Hardness level	Power limitation
2 - 3	up to 4 kW
4 - 5	from 4 to 5 kW
6 - 7	5 kW upwards





If the appliance is set to a lower power level lower than the one indicated in the table above, it may not be possible to select some of the fan speeds.



For models that are not provided with a wireless connection, options U1 and U2 in the user menu will be visible, but not accessible.

Exiting the user menu

There are two ways to exit from the user menu:

- 1 Press the  and  buttons at the same time for at least two seconds. All modifications will be saved and the hob will be switched off. It will then have to be turned back on.

Or

- 2 Press the  button for at least two seconds. Changes will not be saved and the hob will restart, but it will still be powered.

Safety features



See General safety instructions.

Limiting the cooking duration

The appliance has an automatic device that limits the duration of use.



If the cooking settings for a pan are not changed, the maximum operation time for each zone depends on the power level selected.

Heating is switched off when the device for limiting the duration of use is activated.

Power level	Maximum cooking duration in hours
Warming	2
1	9
2	7
3	5 ½
4	4 ½
5	3 ½
6	3
7	2 ½
8	2
9	1 ½
Booster / DBooster	10 minutes

Residual heat indicators

After the cooking zone has been switched off, a symbol appears on each display to indicate whether the zone is still hot and indicates the approximate temperature:

Symbol	Temperature
	> 60°C
	> 80°C
	> 100°C

Protection from overheating

If the hob is used on full power for a long period, the electronics will have trouble cooling down if the room temperature is high.

When certain safety thresholds are reached, on or more cooking zones are deactivated. At the end, if the internal temperature is very high, the appliance is switched off automatically.

Controls lock (on some models only)







This feature is designed to lock all the hob controls during operation, except for the  button.

This is useful when cleaning the appliance and to prevent functions being modified by mistake.

To activate the controls lock function, at least one cooking zone has to be active:

- press the  and  buttons at the same time for at least one second.

The Controls lock is active and the  symbol is shown for each cooking zone.

To deactivate the controls lock, press the  and  buttons at the same time for at least one second; the  symbols disappear.

Controls lock (child safety)





This function prevents the appliance from being switched on unintentionally, for example by children.

To activate the controls lock function, the appliance must be switched on, the cooking zones must not be active and no timer must be enabled:

- Press the  and  buttons at the same time for at least 3 seconds.

The  symbol will appear on the displays of all the cooking zones and on the timer display.

To disable child lock, press buttons  and  at the same time for at least 3 seconds.

Error notifications

If the appliance malfunctions or operates incorrectly, the associated error code appears on the display.

The error codes always begin with the letter "E" or "Er" followed by a series of digits (e.g. "Er47-30").

Errors coded as:

- "E02"
- "E2"
- "Er21"

Indicate that the appliance or part of it is overheating. If this occurs, you should switch off the appliance immediately, remove all pans and let it cool down.

If these errors persist or if other errors appear, make a note of the code and contact Technical Support.

CLEANING AND MAINTENANCE

Cleaning the glass ceramic hob



See General safety instructions.

Cleaning the surfaces

To keep the surfaces in good condition, they should be cleaned regularly after use. Let them cool first.

Ordinary daily cleaning

Always and only use specific products that do not contain abrasives or chlorine-based acids. Pour the product onto a damp cloth and wipe the surface, rinse thoroughly and dry with a soft cloth or a microfibre cloth.



In case of stubborn dirt, clean when cold using a damp kitchen sponge and neutral detergent; then dry with a microfibre cloth.

Weekly cleaning

Clean and maintain the hob once a week using an ordinary glass ceramic cleaning product. Always follow the manufacturer's instructions.

The silicon in these products creates a protective, water-repellent membrane which also resists dirt. All marks stay on the membrane and can therefore be removed easily. After cleaning, dry the surface with a clean cloth. Make sure that there is no detergent left on the cooking surface as it might undergo an aggressive reaction when heated up and could modify the structure of the cooking surface.

Food stains or residues

Light coloured marks from pans with aluminium bases can be easily cleaned off with a cloth moistened in vinegar. Remove any burnt-on residues after cooking; then rinse with water and dry thoroughly with a clean cloth. Dirt, which may have fallen on the hob while cleaning lettuce or potatoes, can scratch the hob when

moving pans. Consequently, remove any dirt from the cooking surface immediately. Changes in colour do not affect the operation and stability of the glass. These are not alterations to the material of the hob but just residues which have not been removed and have then carbonised. Shiny surfaces can form due to the bases of pans, especially aluminium ones, rubbing on the surface, and due to the use of unsuitable detergents. They are difficult to remove using conventional cleaning products. It may be necessary to repeat the cleaning process several times. Use of corrosive detergents or rubbing of pan bases can wear away the decoration on the hob over time and contribute to the formation of stains.



We recommend the use of cleaning products distributed by the manufacturer.



After cleaning, dry the appliance thoroughly to prevent any water or detergent from interfering with its operation or creating unsightly marks.

What to do if...

The hob does not work:

- Make sure that the hob is connected and that the main switch is turned on.

- Make sure that there is no power failure.
- Make sure that the fuse has not blown. In this case replace the fuse.
- Make sure that the circuit breaker of the residential electrical system has not tripped. In this case, reset the circuit breaker.

The cooking results are unsatisfactory:

- Make sure that the cooking temperature is not too high or too low.
- Make sure that the hob is properly ventilated and that the air inlets are unobstructed.
- Use cookware that is certified and tested for induction cooking.

The hob smokes:

- Let the hob cool down and clean it once cooking is complete.
- Make sure that the food has not spilled out of the pan and use a larger cooking vessel, if needed.

The fuses blow or the circuit breaker of the residential electrical system trips repeatedly.

- Call Technical Support or an electrician.

There are cracks or fissures in the hob:

- Turn off the appliance immediately, disconnect the power supply and contact Technical Support.

INSTALLATION

Electrical connection



See General safety instructions.

General information

Check the mains characteristics against the data indicated on the plate.

The identification plate bearing the technical data, serial number and brand name is visibly positioned on the appliance.

Do not remove this plate for any reason.

The appliance must be connected to ground using a wire that is at least 20 mm longer than the other wires.

The appliance can work in the following modes:

80 cm models with 6 zones

380-415 V 3N \sim

5 x 1.5 mm²
five-core cable

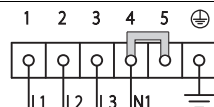

220-240 V 3 \sim / 380-415 V 2N \sim

4 x 2.5 mm²
four-core cable

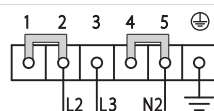

220-240 V 1N \sim

5 x 2.5 mm²
five-core cable

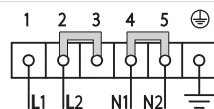

The values indicated refer to the cross-section of the internal lead.



The power cables are sized taking into account the coincidence factor (in compliance with standard EN 60335-2-6).



Use the supplied jumper for each connection, if any

Fixed connection

Fit the power line with an all-pole circuit breaker with a contact separation distance sufficient to provide complete disconnection in category III overvoltage conditions, pursuant to installation regulations.

For the Australian/New Zealand market:

The circuit breaker incorporated in the fixed connection must comply with AS/NZS 3000.

Power limitation procedure



- This procedure is restricted to the installer.
- The appliance is factory set to maximum power.

In order to modify the maximum power absorbed by the appliance, you have to access the user menu (see "User menu"). The power limitation option, as well as the first that is proposed, is marked with the code **110**.

The front and rear right zone displays indicate the numbers associated with the factory set power (expressed in kW - depending on the models):

7.4

Use the scroll bar on the right to modify the power: press the left part to decrease it and the right part to increase it.

The Eco-Logic Advance function increases or decreases the power level in steps of 0.1 kW at each touch.

To exit from the user menu, see the "User menu" chapter.

Table of power draws

Models	Minimum power (kW)	Maximum power (kW)
80 cm with 6 zones	2.4	7.4

Section cut from the countertop

Safety instructions for positioning and installation



See General safety instructions.

- Installation can be carried out on various materials such as masonry, metal, solid wood or plastic laminated wood as long as they are heat resistant (>90°C).
- Veneers, adhesives or plastic coatings on adjacent furniture should be temperature-resistant (>90°C), otherwise they might warp over time.
- If the piece of furniture does not have the required recess opening, either it will have to be cut or masonry work carried out by a competent technician.
- The minimum clearance between exhaust hoods and the cooking surface must be at least the distance indicated in the exhaust hood installation instructions.
- The minimum clearances must also be respected for the edges of the hob on the back as indicated in the assembly instructions.
- If the appliance is to be installed above an oven, the oven must be fitted with a cooling fan.

Appliance overall dimensions (mm)

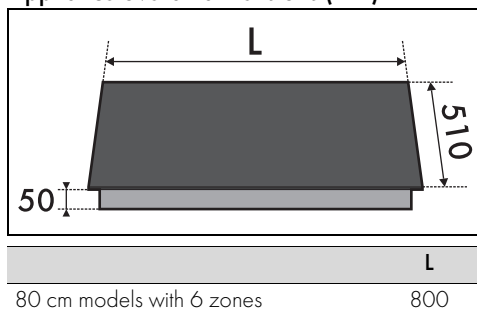

Built-in cabinet dimensions (mm)

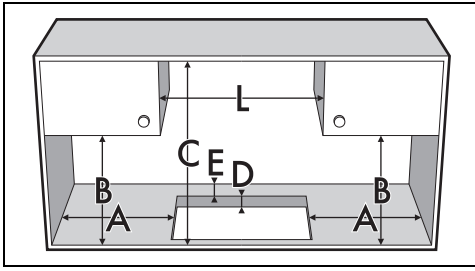

A	min. 50
B	min. 460
C	min. 750
D	30 ÷ 50
E	min. 50
L	min. 800

Hob seal

To prevent leakage of liquid between the frame of the hob and the countertop, place the adhesive seal provided along the entire outer

edge of the hob before assembly.

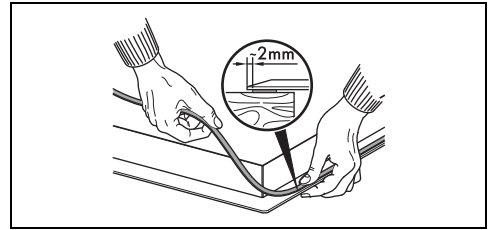

Do not use silicone to secure the hob. This would make it impossible to remove the hob without damaging it.

In the case of flush mounting, after placing the adhesive seal (A) on the glass surface and after positioning and securing the hob, fill the edges with insulating silicone (B) and wipe off any excess. If for any reason the hob needs to be removed, cut the silicone using a cutter before attempting to remove it (C).

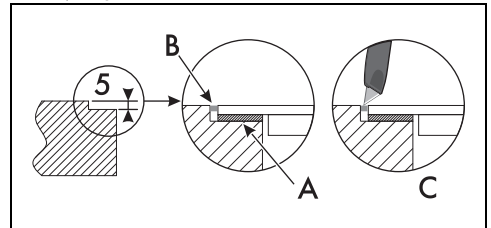

Semi-flush and flush mounting (mm)*

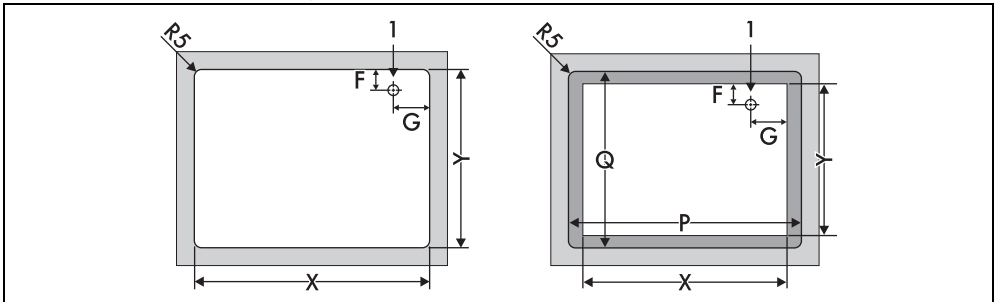

	P	Q	X	Y	F	G
80 cm models with 6 zones	804	514	750 ÷ 780	490	145	330
1	Electrical connection					

*The image on the left represents Semi-Flush cutting, while the image on the right represents Flush cutting. Models with copper profiles can only be installed semi-flush.

Mounting

Over built-in oven unit

The clearance between the hob and the kitchen units or other built-in appliances must be enough

to ensure sufficient ventilation and air discharge. If installed above an oven, a space must be left between the bottom of the hob and the top of

the appliance installed below.

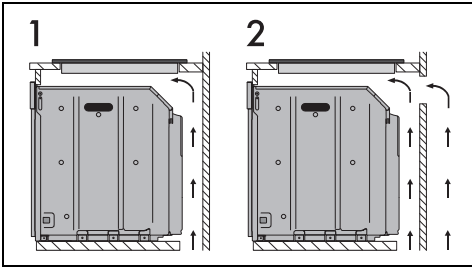

- 1 Opens on bottom
- 2 Opens on bottom and back

On an empty kitchen

If there are other pieces of furniture under the hob, a double-layer wooden base must be installed at least 20 mm from the bottom of the hob to avoid any accidental contact. It must only be possible to remove the double-layer base using suitable equipment.

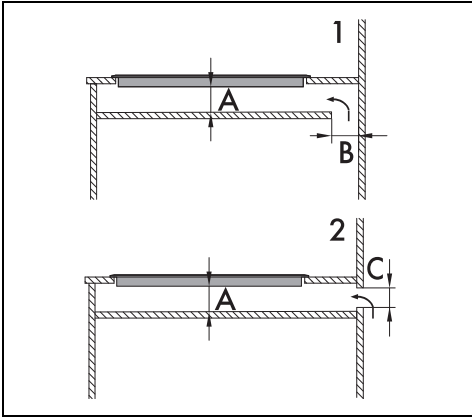

- 1 Opens on bottom
 - 2 Opens on back
- A min. 20 mm - max. 50 mm
B max. 50 mm
C max. 50 mm



Failure to install the double-layer wooden base exposes the user to possible accidental contact with sharp or hot parts.

Fastening to the built-in cabinet

To ensure the hob is fixed and centred as accurately as possible, the clips provided must be positioned as described below:

1. Fit the clips by gently pressing them horizontally into the appropriate space.
2. Then turn them upwards to fix them in place.

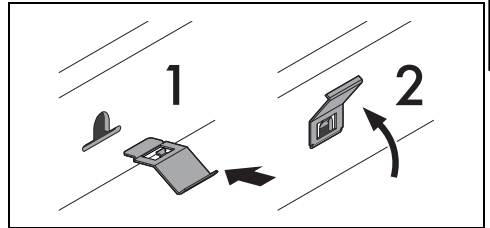

Instructions for the installer

- If you use a plug (if present) to connect to the power supply, the plug must be accessible after installation.
- Do not bend or trap the power cable.
- The appliance must be installed according to the installation diagrams.
- If the appliance does not work correctly after having carried out all the checks, contact your local Authorised Service Centre.
- Once the appliance has been installed, please explain to the user how to use it correctly.