



N64EU3

en	Instruction Manual
it	Manuale di istruzioni
pt	Manual de Instruções
nl	Gebruiksaanwijzing
fr	Notice d'Utilisation
sv	Bruksanvisning
de	Bedienungsanleitung
da	Brugsvejledning
fin	Käyttöohje
no	Bruksanvisning
ru	دليل المستخدم
pl	Instrukcja użytkowania
uk	Посібник користувача



## Please read this manual before using the product!

Dear Customer,

We'd like you to make the best use of our product, which has been manufactured in modern facilities with care and meticulous quality controls.





Thus, we advise you to read the entire user manual before you use the product. In case the product changes hands, do not forget to hand the guide to its new owner along with the product.

### This guide will help you use the product quickly and safely.

- Please read the user guide carefully before installing and operating the product.
- Always observe the applicable safety instructions.
- Keep the user guide within easy reach for future use.
- Please read any other documents provided with the product.

Keep in mind that this user guide may apply to several product models. The guide clearly indicates any variations of different models.













	Important information and useful tips.
	Risk of life and property.
	Risk of electric shock.
	The product's packaging is made of recyclable materials, in accordance with the National Environment Legislation.

 <b>INFORMATION</b>	
 <b>ENERGY</b> SUPPLIER'S NAME:  <b>A</b> MODEL IDENTIFIER:  <b>A</b> (*)	 The model information as stored in the product data base can be reached by entering following website and searching for your model identifier (*) found on energy label. <a href="https://eprel.ec.europa.eu/">https://eprel.ec.europa.eu/</a>

---

## **1- Safety Instructions** **3**

---

-  1.1 Intended Use . . . . . 3
-  1.2 - Safety for children, vulnerable persons and pets . . . . . 3
-  1.3 - Electrical safety . . . . . 4
-  1.4 - Transportation safety . . . . . 4
-  1.5 - Installation safety . . . . . 4
-  1.6- Operational safety . . . . . 5
-  1.7- Maintenance and cleaning safety . . . 6
-  1.8- Lighting . . . . . 6
-  1.9 Compliance with the WEEE Directive and Disposing of the Waste Product . . . . . 6
-  1.10 Compliance with RoHS Directive . . . . 7
-  1.11 Package information . . . . . 7
-  1.12 Service . . . . . 7

---

## **2 Your Refrigerator** **8**

---

### **3 Installation** **9**

---



- 3.1 Appropriate location for installation . . . . . 9
- 3.2 Installing the plastic wedges . . . . . 9
- 3.3 \*Adjusting the feet . . . . . 10
- 3.4 Electric connection . . . . . 11

## **CUSTOMER CARE AND SERVICE**

Always use original spare parts.

When contacting our Authorised Service Centre, ensure that you have the following data available: Model, Serial Number.

The information can be found on the rating plate.

-  Warning / Caution-Safety information
-  General information and tips
-  Environmental information

## **VISIT OUR WEBSITE TO:**



Get usage advice, brochures, trouble shooter, service and repair information:  
[www.smeg.com/services/customer-service](http://www.smeg.com/services/customer-service)

---

## **4 Preparation** **12**

---

- 4.1 Things to be done for saving energy . . . . 12
- 4.2 Recommendations about the fresh food compartment . . . . . 12
- 4.3 Initial use . . . . . 13
- 4.4 Hints and Tips . . . . . 13

---

## **5 Operating the product** **14**

---

- 5.1 Indicator panel . . . . . 14
- 5.2 Freezing fresh food . . . . . 16
- 5.3 Recommendations for preserving the frozen food . . . . . 16
- 5.4 Deep-freeze information . . . . . 16
- 5.5 Placing the food . . . . . 17
- 5.6 Door open warning . . . . . 17
- 5.7 Crisper . . . . . 17
- 5.8 Humidity-controlled crisper . . . . . 17
- 5.9 Egg tray . . . . . 18
- 5.10 Movable Middle Section . . . . . 18
- 5.11 Blue light . . . . . 18
- 5.12 Odour filter . . . . . 18
- 5.13 Making ice . . . . . 18

---

## **6. Maintenance and cleaning** **19**

---

- 6.1 Avoiding bad odours . . . . . 19
- 6.2 Protecting the plastic surfaces . . . . . 19

---

## **7. Troubleshooting** **20**

---

# 1- Safety Instructions

- This section contains safety instructions that will help get protected against risks of personal injury or property damage.
- Our company shall not be responsible for damages that may arise when these instructions are not followed.

 Installation and repair procedures must always be performed by the manufacturer, authorised service agent or a qualified person specified by the importer.

 Only use original parts and accessories.

 Original spare parts will be provided for 10 years, following the product purchasing date.

 Do not repair or replace any part of the product unless specified expressly in the user manual.

 Do not make any technical modifications to the product.

## 1.1 Intended Use

• This product is not suitable for commercial use and it must not be used out of its intended use. This product is designed to be used in houses and indoor places.

For example:

- Personnel kitchens in stores, offices and other working environments,
- Farm houses,

- Areas used by customers at hotels, motels and other types of accommodation,
- Bed&breakfast type hotels, boardinghouses,
- Catering and similar non-retail applications.

This product should not be used outdoors with or without a tent above it such as boats, balconies or terraces. Do not expose the product to rain, snow, sun or wind.

There is the risk of fire!

## 1.2 - Safety for children, vulnerable persons and pets

- This product can be used by children at and above 8 years old and by persons with limited physical, sensory or mental capabilities or who lack experience and knowledge provided that they are supervised or trained on the safe use of the product and the risks it brings out.
- Children aged from 3 to 8 years are allowed to load and unload refrigerating products.
- Electrical products are dangerous for children and pets. Children and pets must not play with, climb or enter the product.
- Cleaning and user maintenance should not be performed by children unless they are supervised by someone.
- Keep packaging materials away from children. There is the risk of injury and suffocation!
- Before disposing of the old or obsolete product:
  1. Unplug the product by gripping from the plug.
  2. Cut the power cable and remove it from the appliance together with its plug
  3. Do not remove the shelves or drawers so that it is harder for children to enter the product.
  4. Remove the doors.
  5. Keep the product in a way that it will not tip over.
  6. Do not allow children play with the old product.
- Never throw the product into fire for disposal. There is the risk of explosion!
- If there is a lock on the door of the product, the key should be kept out of the reach of children.

## Important instructions regarding safety and environment

### 1.3 - Electrical safety

- The product must be unplugged during installation, maintenance, cleaning, repairing and moving procedures.
- If the power cable is damaged, it must be replaced by a qualified person specified by the manufacturer, authorised service agent or importer in order to avoid potential dangers.
- Do not squeeze the power cable under or behind the product. Do not place heavy objects on the power cable. Power cable must not be bent excessively, pinched or get in contact with any heat source.
- Do not use extension cords, multi-sockets or adapters to operate the product.
- Portable multi-sockets or portable power sources can overheat and cause fire. Therefore, do not keep any multi-sockets behind or near the product.
- Plug must be easily accessible. If this is not possible, the electrical installation to which the product is connected must contain a device (such as a fuse, switch, circuit breaker, etc.) which conforms to the electrical regulations and disconnects all poles from the grid.
- Do not touch the power plug with wet hands.
- Remove the plug from the socket by gripping the plug and not the cable.
- Prior to installation, check if the product has any defects on it. If the product is damaged, do not have it installed.
- Place the product on a clean, flat and solid surface and balance it with adjustable feet. Otherwise, the product may tip over and cause injuries.
- The installation location must be dry and well ventilated. Do not place carpets, rugs or similar covers under the product. Insufficient ventilation causes the risk of fire!
- Do not cover or block the ventilation openings. Otherwise, power consumption increases and your product may get damaged.
- Product must not be connected to supply systems such as solar power supplies. Otherwise, your product may get damaged due to sudden voltage changes!
- The more refrigerant a refrigerator contains, the larger the installation location must be. If the installation location is too small, flammable refrigerant and air mixture will accumulate in cases of refrigerant leakage in cooling system. The required space for each 8 gr of refrigerant is 1 m<sup>3</sup> minimum. The amount of refrigerant in your product is indicated on the Type Label.
- Product must not be installed in places exposed to direct sunlight and it must be kept away from heat sources such as hobs, radiators, etc.

### 1.4 - Transportation safety

- Product is heavy; do not move it alone.
  - Do not hold its door when moving the product.
  - Pay attention not to damage the cooling system or the piping during transportation. If the piping is damaged, do not operate the product and call the authorised service agent.
- If it is inevitable to install the product close to a heat source, a suitable insulation plate must be used in between and the following minimum distances must be kept to the heat source:

### 1.5 - Installation safety

- Call the authorised service agent for installation of the product. To make the product ready for use, check the information in the user manual to make sure that the electricity and water installations are suitable. If they are not, call a qualified electrician and plumber to have the necessary arrangements made. Otherwise, there is the risk of electric shock, fire, problems with the product, or injury!
- - Minimum 30 cm away from heat sources such as hobs, ovens, heater units or stoves,  
- Minimum 5 cm away from electric ovens.
- Protection class of your product is Type I. Plug the product in a grounded socket that conforms the voltage, current and frequency values stated on the type label of the product. The socket must be equipped with a 10 A – 16 A circuit breaker. Our company shall not be liable for any damages that will arise when the product is used without grounding and electrical connection in accordance with the local and national regulations.

## Important instructions regarding safety and environment

- Product must not be plugged in during installation. Otherwise, there is the risk of electric shock and injury!
- Do not plug the product in sockets that are loose, dislocated, broken, dirty, greasy or bear the risk of getting in contact with water.
- Route the power cable and hoses (if any) of the product in a way that they do not cause risk of tripping over.
- Exposing the live parts or power cable to humidity may cause short circuit. Therefore, do not install the product in places such as garages or laundry rooms where humidity is high or water may splash. If the refrigerator gets wet with water, unplug it and call the authorised service agent.
- Never connect your refrigerator to energy saving devices. Such systems are harmful to your product.
- Never eat ice cream, ice cubes or frozen food right after removing them from the refrigerator. There is the risk of frostbite!
- When your hands are wet, do not touch the inner walls or metal parts of the freezer or the food stored therein. There is the risk of frostbite!
- Do not place tins or bottles that contain carbonated drinks or freezable liquids in the freezer compartment. Tins and bottles may burst. There is the risk of injury and material damage!
- Do not place or use flammable sprays, flammable materials, dry ice, chemical substances or similar heat-sensitive materials near the refrigerator. There is the risk of fire and explosion!
- Do not store explosive materials that contain flammable materials, such as aerosol cans, in your product.

### 1.6- Operational safety

- Never use chemical solvents on the product. There is the risk of explosion!
- If the product malfunctions, unplug it and do not operate until it is repaired by the authorised service agent. There is the risk of electric shock!
- Do not place flame sources (lit candles, cigarettes, etc.) on or close to the product.
- Do not climb on the product. There is the risk of falling and getting injured!
- Do not damage the pipes of the cooling system with sharp or penetrating objects. The refrigerant that might come out when the refrigerant pipes, pipe extensions or surface coatings are punctured causes skin irritations and eye injuries.
- Unless recommended by the manufacturer, do not place or use electrical devices inside the refrigerator/deep freezer.
- Be careful not to trap your hands or any other part of your body in the moving parts inside the refrigerator. Pay attention not to squeeze your fingers between the door and the refrigerator. Be careful when opening and closing the door particularly if there are children around.
- Do not place containers filled with liquid onto the product. Splashing water on an electrical part may cause electric shock or the risk of fire.
- This product is not intended for storing medicines, blood plasma, laboratory preparations or similar medical substances and products subject to Medical Products Directive.
- Using the product against its intended purpose may cause the products stored inside it to deteriorate or spoil.
- If your refrigerator is equipped with blue light, do not look at this light with optical tools. Do not stare at UV LED lamp directly for a long time. Ultraviolet light may cause eye strain.
- Do not overload the product. Objects in the refrigerator may fall down when the door is opened, causing injury or damage. Similar problems may arise if any object is placed onto the product.
- To avoid injuries, make sure that you have cleaned all the ice and water that may have fallen or splashed on the floor.
- Change the position of the shelves/bottle holders on the door of your refrigerator only when they are empty. There is the risk of injury!
- Do not place objects that can fall down/tip over onto the product. Such objects may fall down when the door is opened and cause injuries and/or material damage.

## Important instructions regarding safety and environment

- Do not hit or exert excessive force on glass surfaces. Broken glass may cause injuries and/or material damage.
- Cooling system of your product contains R600a refrigerant: Type of the refrigerant used in the product is indicated on the type label. This refrigerant is flammable. Therefore, pay attention not to damage the cooling system or the piping while the product is in use. If the piping is damaged:
  - Do not touch the product or the power cable,
  - Keep away potential sources of fire that may cause the product to catch fire.
  - Ventilate the area where the product is located.
- Do not use fans.
  - Call the authorised service agent.
- If the product is damaged and you see refrigerant leak, please stay away from the refrigerant. Refrigerant may cause frostbite in case of skin contact.
- Do not spray or pour water on or inside the product for cleaning purposes. There is the risk of fire and electric shock!
- Do not use sharp or abrasive tools when cleaning the product. Do not use household cleaning products, detergent, gas, gasoline, thinner, alcohol, varnish etc.
- Only use cleaning and maintenance products inside the product that are not harmful for food.
- Never use steam or steam assisted cleaners to clean or defrost the product. Steam gets into contact with the live parts in your refrigerator, causing short circuit or electric shock!
- Make sure that no water enters the electronic circuits or lighting elements of the product.
- Use a clean and dry cloth to wipe the foreign materials or dust on the pins of the plug. Do not use a wet or damp cloth to clean the plug. There is the risk of fire and electric shock!

### For products with a Water Dispenser/ Ice Machine

- Use only potable water. Do not fill the water tank with any liquids -such as fruit juice, milk, carbonated beverages or alcoholic drinks- that are not suitable for use in the water dispenser.
- There is the risk for health and safety!
- Do not allow children play with the water dispenser or ice machine (Icematic) in order to prevent accidents or injuries.
- Do not insert your fingers or other objects into the water dispenser hole, water channel or ice machine container. There is the risk of injury or material damage!

### 1.7- Maintenance and cleaning safety

- Do not pull from the door handle if you need to move the product for cleaning purposes. Handle may break and cause injuries if you exert excessive force on it.

### 1.8- Lighting

- Call the authorised service when it is required to replace the LED/bulb used for lighting.

### 1.9 Compliance with the WEEE Directive and Disposing of the Waste Product

This product complies with EU WEEE Directive (2012/19/EU). This product bears a classification symbol for waste electrical and electronic equipment (WEEE).



This symbol indicates that this product shall not be disposed with other household wastes at the end of its service life. Used device must be returned to official collection point for recycling of electrical and electronic devices. To find these collection systems please contact to your local authorities or retailer where the product was purchased. Each household performs important role in recovering and recycling of old appliance. Appropriate disposal of used appliance helps prevent potential negative consequences for the environment and human health.

### 1.10 Compliance with RoHS Directive

The product you have purchased complies with EU RoHS Directive (2011/65/EU). It does not contain harmful and prohibited materials specified in the Directive.

### 1.11 Package information



Packaging materials of the product are manufactured from recyclable materials in accordance with our National Environment Regulations. Do not dispose of the packaging materials together with the domestic or other wastes. Take them to the packaging material collection points designated by the local authorities.

### 1.12 Service

- To repair the appliance contact the Authorised Service Centre. Use original spare parts only.
- Please note that self-repair or nonprofessional repair can have safety consequences and might void the guarantee.
- The following spare parts will be available for 7 years after the model has been discontinued: thermostats, temperature sensors, printed circuit boards, light sources, door handles, door hinges, trays and baskets. Please note that some of these spare parts are only available to professional repairers, and that not all spare parts are relevant for all models.
- Door gaskets will be available for 10 years after the model has been discontinued.



## 2 Your Refrigerator

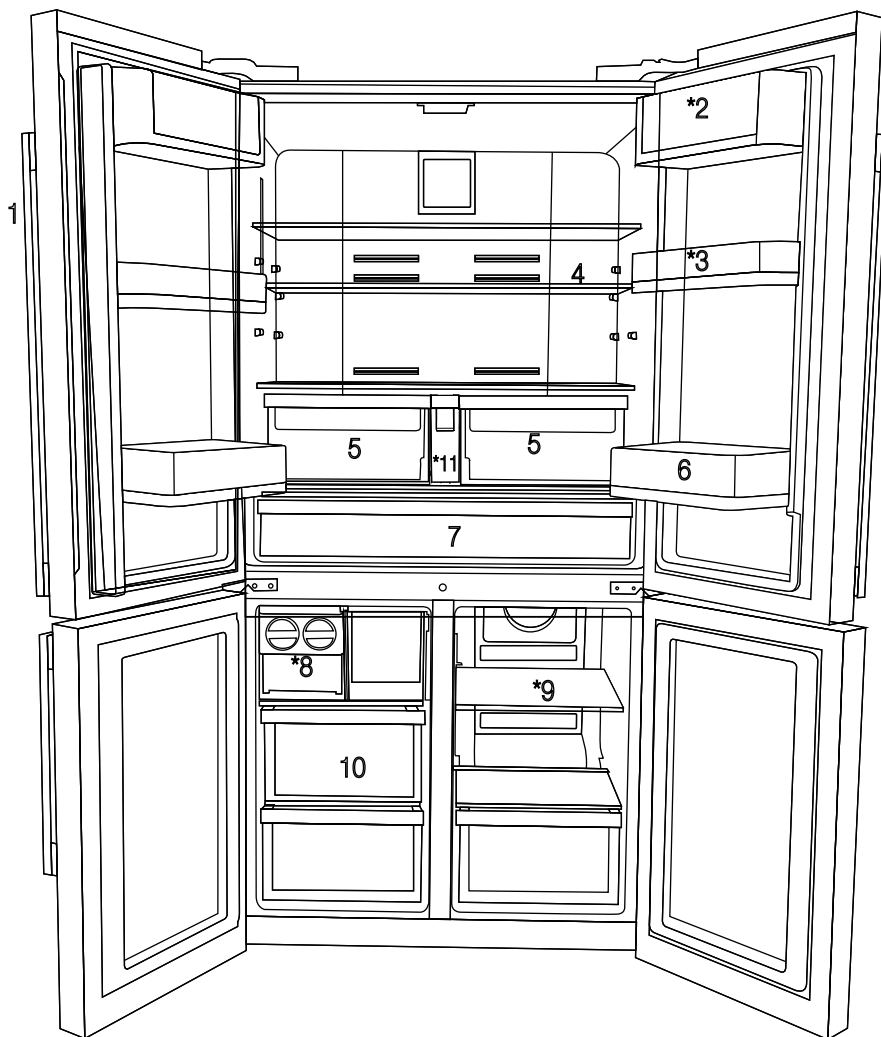

- 1- Control and indicator panel
  - 2- Butter & Cheese section
  - 3- 70 mm moving door shelf
  - 4- Fridge compartment glass shelf
  - 5- Fridge compartment crisper
  - 6- Gallon door shelf
  - 7- Dairy compartment
  - 8- Icebox drawer
  - 9- Freezer compartment glass shelf/cooler
  - 10- Freezer compartment drawers
  - 11- Water tank
- \* OPTIONAL



Figures in this user manual are schematic and may not match the product exactly. If the subject parts are not included in the product you have purchased, then those parts are valid for other models.

## 3 Installation

### 3.1 Appropriate location for installation

Contact an Authorized Service for the installation of the product. In order to prepare the product for use, refer the information in the user manual and ensure that electrical installation and water installation are appropriate. If not, call a qualified electrician and technician to have any necessary arrangements carried out.

	<b>WARNING:</b> Manufacturer shall not be held liable for damages that may arise from procedures carried out by unauthorized persons.
	<b>WARNING:</b> Product must not be plugged in during installation. Otherwise, there is the risk of death or serious injury!
	<b>WARNING:</b> : If the door clearance of the room where the product shall be placed is so tight to prevent passing of the product, remove the door of the room and pass the product through the door by turning it to its side; if this does not work, contact the authorized service.

- Place the product on a level floor surface to prevent jolts.
- Install the product at least 30 cm away from heat sources such as hobs, heater cores and stoves and at least 5 cm away from electrical ovens.
- Product must not be subjected to direct sun light and kept in humid places.
- Your product requires adequate air circulation to function efficiently. If the product will be placed in a niche, remember to leave at least 5 cm clearance between the product and the ceiling, rear wall and the side walls.
- If the product will be placed in a niche, remember to leave at least 5 cm clearance between the product and the ceiling, rear wall and the side walls. Check if the rear wall clearance protection component is present at its location (if provided with the product). If the component is not available, or if it is lost or

fallen, position the product so that at least 5 cm clearance shall be left between the rear surface of the product and the wall of the room. The clearance at the rear is important for efficient operation of the product.

- Do not install the product in places where the temperature falls below  $-5^{\circ}\text{C}$ .

### 3.2 Installing the plastic wedges

Plastic wedges supplied with the product are used to create the distance for the air circulation between the product and the rear wall.

1. To install the wedges, remove the screws on the product and use the screws supplied together with the wedges.

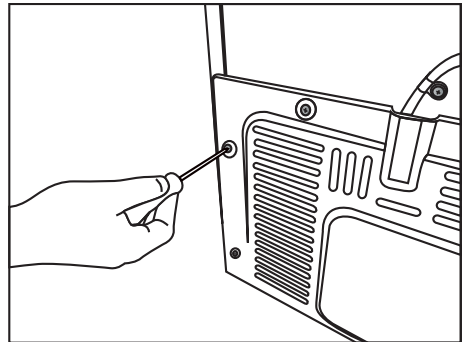

2. Insert the 2 plastic wedges onto the rear ventilation cover as illustrated in the figure.

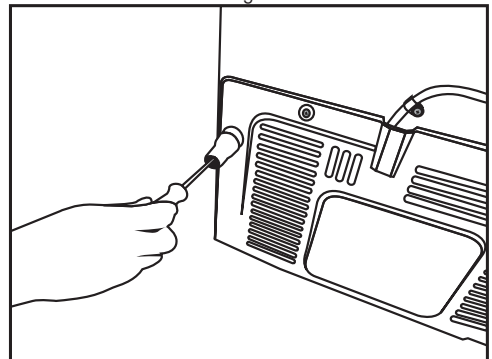

## Installation

### 3.3 \*Adjusting the feet

If the product stands unbalanced after installation, adjust the feet on the front by rotating them to the right or left.

\*If your product does not have a wine compartment or is not a glass door, your product does not have adjustable stands, the product has fixed stands.

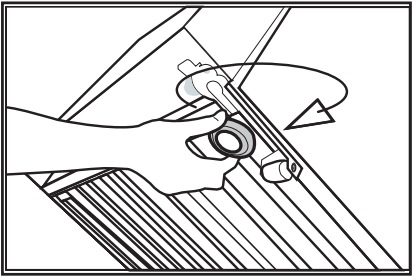
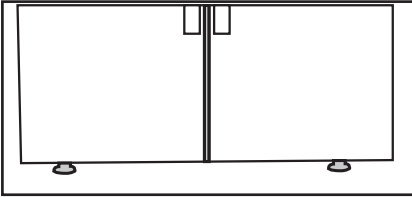

To adjust the doors vertically,

Loosen the fixing nut located at the bottom.

Rotate the adjusting nut according to the position of the door (clockwise/counter-clockwise).

Tighten the fixing nut in order to fix the position.

To adjust the doors horizontally,

Loosen the fixing nut located at the top.

Rotate the side adjusting nut according to the position of the door (clockwise/counter-clockwise).

Tighten the fixing nut which is at the top in order to fix the position.

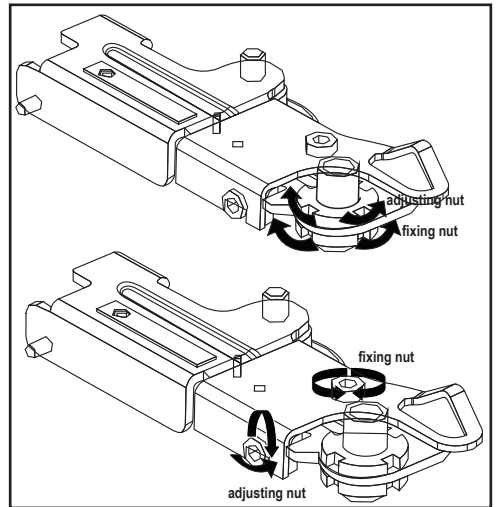

## Installation

- Upper hinge group is fixed with 3 screws.
- The hinge cover is attached after the sockets are installed.
- Then the hinge cover is fixed with two screws.

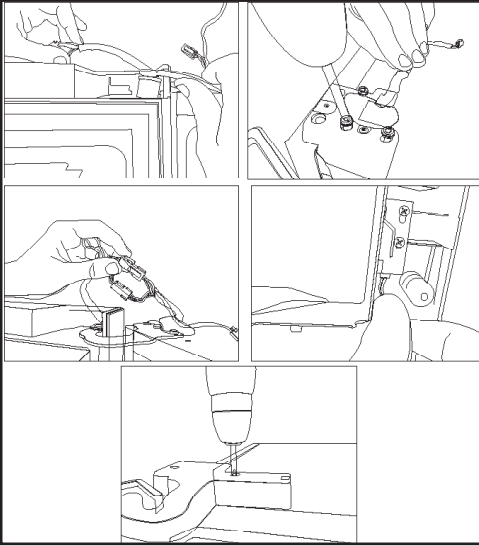

## Positioning

This appliance should be installed in a dry, well ventilated indoor position.

This appliance is intended to be used at ambient temperature ranging from 10°C to 43°C.

## 3.4 Electric connection



**WARNING:** Do not make connections via extension cables or multi-plugs.



**WARNING:** Damaged power cable must be replaced by the Authorized Service Agent.



If two coolers are to be installed side by side, there should be at least 4 cm distance between them.

- Our company shall not be liable for any damages that will arise when the product is used without grounding and electrical connection in accordance with the national regulations.
- Power cable plug must be within easy reach after installation.
- Do not extension cords or cordless multiple outlets between your product and the wall outlet.

## 4 Preparation

### 4.1 Things to be done for saving energy



Connecting your refrigerator to systems that save energy is dangerous as they may cause damage on the product.

- For a freestanding appliance; this refrigerating appliance is not intended to be used as a built-in appliance.
- Do not leave the doors of your refrigerator open for a long time.
- Do not put hot food or drinks in your refrigerator.
- Do not overload the refrigerator. Cooling capacity will fall when the air circulation in the refrigerator is hindered.
- Do not place the refrigerator in places subject to direct sunlight. Install the product at least 30 cm away from heat sources such as hobs, ovens, heater units and stoves and at least 5 cm away from electrical ovens.
- Pay attention to store your food in refrigerator in closed containers.
- Since hot and humid air will not directly penetrate into your product when the doors are not opened, your product will optimize itself in conditions sufficient to protect your food. Functions and components such as compressor, fan, heater, defrost, lighting, display and so on will operate according to the needs to consume minimum energy under these circumstances.
- In case of multiple options are present glass shelves must be placed so that the air outlets at the backwall are not blocked, preferably air outlets are remaining below the glass shelf. This combination may help improving air distribution and energy efficiency.
- To be able store maximum food in the freezer compartment of your refrigerator, the upper drawer has to be removed and placed on top of glass shelf. Power consumption stated for your refrigerator has been determined after removing the icematic and the upper drawers as to allow maximum loading. It is strongly recommended to use the lower drawers in the freezer and the multizone compartment while loading.

- Airflow should not be blocked by placing foods in front of the freezer and the multizone compartment fans. Foods should be loaded by leaving minimum 5 cm space in front of the protective fan grid.
- Thawing the frozen foods in the fridge compartment both saves energy and reserves the quality of the foods.



Temperature of the room where your refrigerator is located should at least be 10°C /50°F. Operating your refrigerator under cooler conditions is not recommended with regard to its efficiency.



Inside of your refrigerator must be cleaned thoroughly.



If two coolers are to be installed side by side, there should be at least 4 cm distance between them.

### 4.2 Recommendations about the fresh food compartment

- Make sure that the food does not touch the temperature sensor in fresh food compartment. To allow the fresh food compartment to keep its ideal storage temperature, the sensor must not be hindered by food.
- Do not place hot foods or beverages inside the product.

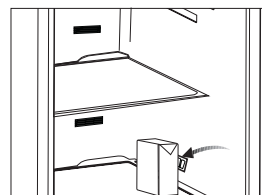
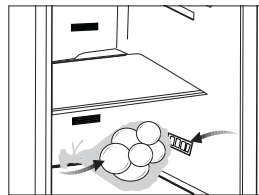

### 4.3 Initial use

Before using the product, make sure that all preparations have been made in accordance with the instructions given in the "Important instructions regarding safety and environment" and "Installation" chapters.

- Clean the interior of the refrigerator as recommended in the "Maintenance and cleaning" section. Before you start the refrigerator, make sure that the interior is dry.
- Plug the refrigerator in a grounded socket. The interior illumination is lit when the door of the refrigerator is opened.
- Operate the refrigerator for 6 hours without placing any food in it and do not open its door unless it is necessary.



You will hear a noise when the compressor starts up. The liquids and gases sealed within the refrigeration system may also give rise to noise, even if the compressor is not running and this is quite normal.



Front edges of the refrigerator may feel warm. This is normal. These areas are designed to be warm to avoid condensation.

### 4.4 Hints and Tips

#### Hints for energy saving

- Most efficient use of energy is ensured in the configuration with the drawers in the bottom part of the appliance and shelves evenly distributed. Position of the door bins does not affect energy consumption.
- Do not open the door frequently or leave it open longer than necessary.
- Do not set too high temperature to save energy unless it is required by the characteristics of the food.
- If the ambient temperature is high and the temperature control is set to low temperature and the appliance is fully loaded, the compressor may run continuously, causing frost or ice formation on the evaporator. In this case, set the temperature control toward higher temperature to allow automatic defrosting and to save energy this way.

- Ensure a good ventilation. Do not cover the ventilation grilles or holes.

#### Hints for fresh food refrigeration

- Good temperature setting that ensures preservation of fresh food is a temperature less than or equal to +4°C.  
Higher temperature setting inside the appliance may lead to shorter shelf life of food.
- Cover the food with packaging to preserve its freshness and aroma.
- Always use closed containers for liquids and for food, to avoid flavours or odours in the compartment.
- To avoid the cross-contamination between cooked and raw food, cover the cooked food and separate it from the raw one.
- It is recommended to defrost the food inside the fridge.
- Do not insert hot food inside the appliance. Make sure it has cooled down at room temperature before inserting it.
- To prevent food waste the new stock of food should always be placed behind the old one.

#### Hints for food refrigeration

- Meat (all types): wrap in a suitable packaging and place it on the glass shelf above the vegetable drawer. Store meat for at most 1 -2 days.

## 5 Operating the product

### 5.1 Indicator panel

Touch-control indicator panel allows you to set the temperature and control the other functions related to the product. Just press the relevant buttons for function settings.

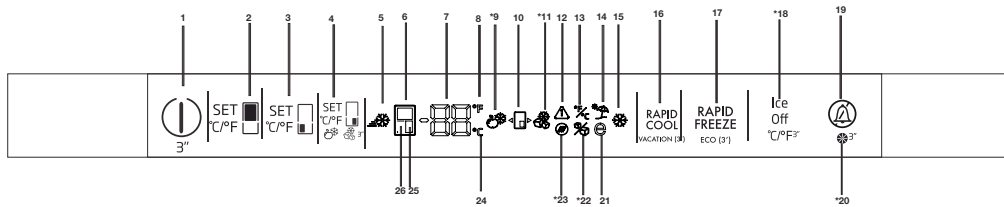

#### 1-On/Off function

Press the On/Off button for 3 seconds to turn off or turn on the fridge.

#### 2. Temperature Adjustment Fridge

When pressed decreases the temperature of the fridge compartment.

#### 3. Temperature Adjustment Freezer

When pressed decreases the temperature of the freezer compartment.

#### 4. Temperature Adjustment Joker

When pressed decreases the temperature of the joker compartment.

#### 5-Quick freeze Indicator

This icon lits when the Quick freeze function is active.

#### 6. Fridge compartment indicator

When this indicator is active, the temperate of the fridge compartment is displayed on the temperature value indicator. Fridge compartment can be set to 8, 7, 6, 5, 4, 3, 2 or 1°C / 46, 45, 44, 43, 42, 41, 40, 39, 38, 37, 36, 35, 34 or 33°F by pressing Temperature Adjustment button (2).

#### 7. Temperature value indicator

Shows the temperature value of the selected compartment.

#### 8. Fahrenheit indicator

It is a Fahrenheit indicator. When the Fahrenheit

**\* (in some models)**

indication is activated, the temperature set values are shown in Fahrenheit and the relevant icon turns on.

#### 9. Joker fridge icon

This icon indicates that joker cabin in fridge mode. Mode can be change by pressing joker set button (4) 3 seconds.

#### 10. Joker cabin icon

It shows joker cabin icon.

#### 11. Joker freezer icon

This icon indicates that joker cabin in freezer mode. Mode can be change by pressing joker set button (4) 3 seconds.

#### 12. Power failure/High temperature / error warning

This indicator illuminates during power failure, high temperature failures and error warnings. During long-term power failures, the highest temperature value that the freezer compartment reaches will blink on the digital display. After checking the food located in the freezer compartment, press the alarm off button (19) to clear the warning.

#### 13. Setting the Celsius and Fahrenheit indicator

By pressing 3 seconds to ice off 18 temperature unit can be changed between celcius and fahrenheit .When the relevant temperature type is selected, the Fahrenheit and Celsius indicator turns on.



Figures in this user manual are schematic and may not match the product exactly. If the subject parts are not included in the product you have purchased, then those parts are valid for other models.

## Operating the product

### 14. Vacation function icon

When you press the Quick cool button, (3 seconds) the vacation function indicator lights continuously and thus the Vacation function is activated. Press the Quick cool button key, (3 seconds) to cancel the vacation function. Thus, the vacation function will be cancelled.

### 15. Quick cooling function indicator

It turns on when the quick fridge function is activated.

### 16. Quick cooling function button

The button has two functions. To activate or deactivate the quick cool function, press it briefly. Quick Cool indicator will turn off and the product will return to its normal settings.

### 17. Quick freeze function button

Press this button to activate or deactivate the quick freeze function. When you activate the function, the freezer compartment will be cooled to a temperature lower than the set value.



Use the quick freeze function when you want to quickly freeze the food placed in freezer compartment. If you want to freeze large amounts of fresh food, activate this function before putting the food into the product.



If you do not cancel it, Quick Freeze will cancel itself automatically after **24** hours at the most or when the fridge compartment reaches to the required temperature.



This function is not recalled when power restores after a power failure.

### 18. Ice off function button

The button has to function. To activate or deactivate ice off function press it briefly.

### 19. Alarm off warning

In case of power failure/high temperature alarm, after checking the foods in the freezer compartment, press the alarm off button to clear the High temperature warning icon (12).

### 20. Filter reset

The filter is reset when the alarm off button (19) is pressed for 3 seconds. Filter reset icon goes off.

### 21. Eco fuzzy function icon

When you press the Quick freeze (17) button 3 seconds Eco fuzzy function will be activated / deactivated eco fuzzy function icon will be on when function activated.

### 22. Ice machine off icon

When you press the ice off (18) button Ice off function will be activated / deactivated ice machine function icon will be on when function activated.



Indicates whether the icematic is on or off.



Water flow from water tank will stop when this function is selected. However, ice made previously can be taken from the icematic.

### 23. Filter reset icon

This icon turns on when the filter needs to be reset.

### 24. Celsius indicator

It is a Celsius indicator. When the Celsius indication is activated, the temperature set values are shown in Celsius and the relevant icon turns on.

### 25. Joker compartment indicator

When this indicator is active, the temperature of the joker compartment is displayed on the temperature value indicator. Joker compartment set values change by pressing Temperature Adjustment button (4).

### 26. Freezer compartment indicator

When this indicator is active, the temperature of the freezer compartment is displayed on the temperature value indicator. Freezer compartment can be set to -16, -18, -19, -20, -21, -22 and -24 °C / 0, -2, -4, -6, -8, -10 and -12°F by pressing Temperature Adjustment button (3).



## Operating the product

Freezer Compartment Setting	Fridge Compartment Setting	Remarks
-18°C	4°C	This is the normal recommended setting.
-20, -22 or -24°C	4°C	These settings are recommended when the ambient temperature exceeds 30°C.
Quick Freeze	4°C	Use when you wish to freeze your food in a short time. Your product will return to its previous mode when the process is over.
-18°C or colder	2°C	Use these settings if you think that your fridge compartment is not cold enough because of the hot ambient conditions or frequent opening and closing of the door.

### 5.2 Freezing fresh food

- In order to preserve the quality of the food, it shall be frozen as quickly as possible when it is placed in the freezer compartment, use the fast freezing feature for this purpose.
- You may store the food longer in freezer compartment when you freeze them while they are fresh.
- Pack the food to be frozen and close the packing so that it would not allow entrance of air.
- Ensure that you pack your food before putting them in the freezer. Use freezer containers, foils and moisture-proof papers, plastic bags and other packing materials instead of traditional packing papers.
- Label each pack of food by adding the date before freezing. You may distinguish the freshness of each food pack in this way when you open your freezer each time. Store the food frozen before in the front side of compartment to ensure that they are used first.
- Frozen food must be used immediately after they are thawed and they should not be re-frozen.
- Do not freeze too large quantities of food at one time.
- 24 hours before freezing the fresh food, activate "Quick Freeze Function".
- The fresh food packages should be placed in bottom drawers.
- After placing fresh food packages, activate "Quick Freeze Function" again.
- When the freezer cabinet is set to quick function, joker cabinet is also set to quick function automatically.

### 5.3 Recommendations for preserving the frozen food

Compartment shall be set to -18°C at least.

1. Put packages in the freezer as quickly as possible after purchase without allowing the to thaw.
2. Check whether the "Use By" and "Best Before" dates on the packaging are expired or not before freezing it.
3. Ensure that the package of the food is not damaged.

### 5.4 Deep-freeze information

According to IEC 62552 standards, the product shall freeze at least 4.5 kg of food at 25°C ambient temperature to -18°C or lower within 24 hours for every 100-litres of freezer volume.

It is possible to preserve the food for a long time only at -18°C or lower temperatures.

You can keep the freshness of food for many months (at -18°C or lower temperatures in the deep freeze).

Foods to be frozen should not be allowed to come in contact with the previously frozen items to prevent them from getting thawed partially.

## Operating the product

Boil the vegetables and drain their water in order to store vegetables for a longer time as frozen. After draining their water, put them in air-proof packages and place them inside the freezer. Food such as bananas, tomatoes, lettuce, celery, boiled eggs, potatoes are not suitable for freezing. When these foods are frozen, only their nutritional value and taste shall be affected negatively. They shall not be spoiled so that they would create a risk for human health.

### 5.5 Placing the food

Freezer compartment shelves	Various frozen food such as meat, fish, ice cream, vegetables and etc.
Refrigerator compartment shelves	Food in pans, covered plates and closed containers, eggs (in closed container)
Door shelves of fridge compartment	Small and packaged food or beverage
Crisper	Vegetables and fruits
Fresh zone compartment	Delicatessen (breakfast food, meat products that shall be consumed in a short time)

### 5.6 Door open warning

#### (This feature is optional)

The door open alert system of your refrigerator may differ depending on the model.

Version 1;

If the door of the product remains open for a certain time (between 60 s and 120 s), an audio warning signal sounds; depending on the product model, a visual warning signal (light flash) can also be displayed. If you close the door of the device or press a button on the screen of the device, if any, the warning sound will stop.

Version 2;

If the door of the device remains open for a certain period of time (between 60 s and 120 s), the door open alert is sounded. The door open alert is sounded gradually. First, an audible warning starts to sound. After 4 minutes, if the door is still not closed, a visual warning (lighting flash) is activated. The door open alert will be delayed for a certain period of time (between 60 s and 120 s) when any key on the product screen, if any, is pressed. Then the process will start again. When the device door is closed, the door open alert will be cancelled.

### 5.7 Crisper

Crisper of the refrigerator is designed specially to keep the vegetables fresh without losing their humidity. For this purpose, cool air circulation is intensified around the crisper in general. Remove the door shelves that stand against the crisper before removing the crisper.

### 5.8 Humidity-controlled crisper

#### (This feature is optional)

Humidity rates of fruits and vegetables are kept under control thanks to the humidity-controlled crisper and thus the food is ensured to stay fresh for a longer period.

We recommend that you place leafy vegetables such as lettuce and spinach and vegetables sensitive to humidity loss as horizontally as possible when putting them in the crisper; not in a horizontal position on their roots.

While the vegetables are being replaced, their specific weights should be taken into consideration. Heavy and hard vegetables must be placed at the bottom of the crisper and light and soft vegetables must be on the upper part.

Never leave the vegetables in their plastic bags in the crisper. If they are left in their plastic bags, this will cause them to rot in a little while. If you not prefer the vegetable to get in contact with other vegetables for hygienic reasons, use perforated paper or a similar material instead of plastic bags. Do not place pears, apricots, peaches etc.,

## Operating the product

especially those fruits that generate large amounts of ethylene, in the same crisper with other fruits and vegetables. The ethylene gas emitted by these fruits cause other fruits to ripen sooner and to rot in a shorter span of time.

### 5.9 Egg tray

You can install the egg holder to the desired door or body shelf.

Never keep the egg holder in the freezer compartment.

### 5.10 Movable Middle Section

Movable middle section is intended to prevent the cold air inside your refrigerator from escaping outside.



1- Sealing is provided when the gaskets on the door presses on the surface of the movable middle section while the fridge compartment doors are closed.

2- Another reason that your refrigerator is equipped with a movable middle section is that it increases the net volume of the fridge compartment. Standard middle sections occupy some non-usable volume in the refrigerator.

3-Movable middle section is closed when the left door of the fridge compartment is opened.

4-It must not be opened manually. It moves under the guidance of the plastic part on the body while the door is closed.

### 5.11 Blue light

(in some models)

Crisper of the refrigerator are illuminated with a blue light. Foodstuff stored in the crisper continue their photosynthesis by means of the wavelength effect of blue light and thus, preserve their freshness and increase their vitamin content.

### 5.12 Odour filter

Odour filter in the air duct of the fridge compartment prevents build-up of unpleasant odours in the refrigerator.

### 5.13 Making ice

(in some models)

Fill the ice container with water and place it into the freezer compartment. Your ice will be ready approximately in two hours.

You can remove the ice in the ice container by removing it from the freezer and twisting it.

## 6. Maintenance and cleaning

Cleaning your fridge at regular intervals will extend the service life of the product.



### WARNING:

Unplug the product before cleaning it.

- Never use gasoline, benzene or similar substances for cleaning purposes.
- Never use any sharp and abrasive tools, soap, household cleaners, detergent and wax polish for cleaning.
- For non-No Frost products, water drops and frosting up to a fingerbreadth occur on the rear wall of the Fridge compartment. Do not clean it; never apply oil or similar agents on it.
- Only use slightly damp microfiber cloths to clean the outer surface of the product. Sponges and other types of cleaning cloths may scratch the surface
- Dissolve one teaspoon of bi-carbonate in half litre of water. Soak a cloth with the solution and wrung it thoroughly. Wipe the interior of the refrigerator with this cloth and the dry thoroughly.
- Make sure that no water enters the lamp housing and other electrical items.
- If you will not use the refrigerator for a long period of time, unplug it, remove all food inside, clean it and leave the door ajar.
- Check regularly that the door gaskets are clean. If not, clean them.
- To remove door and body shelves, remove all of its contents.
- Remove the door shelves by pulling them up. After cleaning, slide them from top to bottom to install.
- Never use cleaning agents or water that contain chlorine to clean the outer surfaces and chromium coated parts of the product. Chlorine causes corrosion on such metal surfaces.

### 6.1 Avoiding bad odours

- Materials that may cause odour are not used in the production of our refrigerators. However, due to inappropriate food preserving conditions and not cleaning the inner surface of the refrigerator as required can bring forth the problem of odour. Pay attention to following to avoid this problem:
- Keeping the refrigerator clean is important. Food residuals, stains, etc. can cause odour. Therefore, clean the refrigerator with bi-carbonate dissolved in water every few months. Never use detergents or soap.
- Keep the food in closed containers. Microorganisms spreading out from uncovered containers can cause unpleasant odours.
- Never keep the food that have passed best before dates and spoiled in the refrigerator.

### 6.2 Protecting the plastic surfaces

Do not put liquid oils or oil-cooked meals in your refrigerator in unsealed containers as they damage the plastic surfaces of the refrigerator. If oil is spilled or smeared onto the plastic surfaces, clean and rinse the relevant part of the surface at once with warm water.

## 7. Troubleshooting

Check this list before contacting the service. Doing so will save you time and money. This list includes frequent complaints that are not related to faulty workmanship or materials. Certain features mentioned herein may not apply to your product.

### **The refrigerator is not working.**

- The power plug is not fully settled. >>> Plug it in to settle completely into the socket.
- The fuse connected to the socket powering the product or the main fuse is blown. >>> Check the fuses.

### **Condensation on the side wall of the cooler compartment (MULTI ZONE, COOL, CONTROL and FLEXI ZONE).**

- The door is opened too frequently >>> Take care not to open the product's door too frequently.
- The environment is too humid. >>> Do not install the product in humid environments.
- Foods containing liquids are kept in unsealed holders. >>> Keep the foods containing liquids in sealed holders.
- The product's door is left open. >>> Do not keep the product's door open for long periods.
- The thermostat is set to too low temperature. >>> Set the thermostat to appropriate temperature.

### **Compressor is not working.**

- In case of sudden power failure or pulling the power plug off and putting back on, the gas pressure in the product's cooling system is not balanced, which triggers the compressor thermic safeguard. The product will restart after approximately 6 minutes. If the product does not restart after this period, contact the service.
- Defrosting is active. >>> This is normal for a fully-automatic defrosting product. The defrosting is carried out periodically.
- The product is not plugged in. >>> Make sure the power cord is plugged in.
- The temperature setting is incorrect. >>> Select the appropriate temperature setting.
- The power is out. >>> The product will continue to operate normally once the power is restored.

### **The refrigerator's operating noise is increasing while in use.**

- The product's operating performance may vary depending on the ambient temperature variations. This is normal and not a malfunction.

### **The refrigerator runs too often or for too long.**

- The new product may be larger than the previous one. Larger products will run for longer periods.
- The room temperature may be high. >>> The product will normally run for long periods in higher room temperature.
- The product may have been recently plugged in or a new food item is placed inside. >>> The product will take longer to reach the set temperature when recently plugged in or a new food item is placed inside. This is normal.
- Large quantities of hot food may have been recently placed into the product. >>> Do not place hot food into the product.
- The doors were opened frequently or kept open for long periods. >>> The warm air moving inside will cause the product to run longer. Do not open the doors too frequently.
- The freezer or cooler door may be ajar. >>> Check that the doors are fully closed.
- The product may be set to temperature too low. >>> Set the temperature to a higher degree and wait for the product to reach the adjusted temperature.
- The cooler or freezer door washer may be dirty, worn out, broken or not properly settled. >>> Clean or replace the washer. Damaged / torn door washer will cause the product to run for longer periods to preserve the current temperature.

### **The freezer temperature is very low, but the cooler temperature is adequate.**

- The freezer compartment temperature is set to a very low degree. >>> Set the freezer compartment temperature to a higher degree and check again.

### **The cooler temperature is very low, but the freezer temperature is adequate.**

- The cooler compartment temperature is set to a very low degree. >>> Set the freezer compartment temperature to a higher degree and check again.

## Troubleshooting

### The food items kept in cooler compartment drawers are frozen.

- The cooler compartment temperature is set to a very low degree. >>> Set the freezer compartment temperature to a higher degree and check again.

### The temperature in the cooler or the freezer is too high.

- The cooler compartment temperature is set to a very high degree. >>> Temperature setting of the cooler compartment has an effect on the temperature in the freezer compartment. Wait until the temperature of relevant parts reach the sufficient level by changing the temperature of cooler or freezer compartments.
- The doors were opened frequently or kept open for long periods. >>> Do not open the doors too frequently.
- The door may be ajar. >>> Fully close the door.
- The product may have been recently plugged in or a new food item is placed inside. >>> This is normal. The product will take longer to reach the set temperature when recently plugged in or a new food item is placed inside.
- Large quantities of hot food may have been recently placed into the product. >>> Do not place hot food into the product.

### Shaking or noise.

- The ground is not level or durable. >>> If the product is shaking when moved slowly, adjust the stands to balance the product. Also make sure the ground is sufficiently durable to bear the product.
- Any items placed on the product may cause noise. >>> Remove any items placed on the product.

### The product is making noise of liquid flowing, spraying etc.

- The product's operating principles involve liquid and gas flows. >>> This is normal and not a malfunction.

### There is sound of wind blowing coming from the product.

- The product uses a fan for the cooling process. This is normal and not a malfunction.

### There is condensation on the product's internal walls.

- Hot or humid weather will increase icing and condensation. This is normal and not a malfunction.
- The doors were opened frequently or kept open for long periods. >>> Do not open the doors too frequently; if open, close the door.
- The door may be ajar. >>> Fully close the door.

### There is condensation on the product's exterior or between the doors.

- The ambient weather may be humid, this is quite normal in humid weather. >>> The condensation will dissipate when the humidity is reduced.

### The interior smells bad.

- The product is not cleaned regularly. >>> Clean the interior regularly using sponge, warm water and carbonated water.
- Certain holders and packaging materials may cause odour. >>> Use holders and packaging materials without free of odour.
- The foods were placed in unsealed holders. >>> Keep the foods in sealed holders. Micro-organisms may spread out of unsealed food items and cause malodour. Remove any expired or spoilt foods from the product.

### The door is not closing.

- Food packages may be blocking the door. >>> Relocate any items blocking the doors.
- The product is not standing in full upright position on the ground. >>> Adjust the stands to balance the product.
- The ground is not level or durable. >>> Make sure the ground is level and sufficiently durable to bear the product.

### The vegetable bin is jammed.

- The food items may be in contact with the upper section of the drawer. >>> Reorganize the food items in the drawer.

### If The Surface Of The Product Is Hot.

- High temperatures may be observed between the two doors, on the side panels and at the rear grill while the product is operating. This is normal and does not require service maintenance! Be careful when touching these areas.



#### WARNING:

If the problem persists after following the instructions in this section, contact your vendor or an Authorised Service. Do not try to repair the product.

## **TECHNICAL DATA**

The technical information is situated in the rating plate on the internal side of the appliance and on the energy label.

The QR code on the energy label supplied with the appliance provides a web link to the information related to the performance of the appliance in the EU EPREL database. Keep the energy label for reference together with the user manual and all other documents provided with this appliance.

It is also possible to find the same information in EPREL using the link <https://eprel.ec.europa.eu> and, the model name and product number that you find on the rating plate of the appliance.

## **INFORMATION FOR TEST INSTITUTES**

Installation and preparation of the appliance for any EcoDesign verification shall be compliant with EN 62552. Ventilation requirements, recess dimensions and minimum rear clearances shall be as stated in this User Manual at Chapter 3. Please contact the manufacturer for any other further information, including loading plans.

**This product is equipped with a lighting source of the "G" energy class.**

**The lighting source in this product shall only be replaced by professional repairers.**

58 6338 0000/AK

5/5

UK

