

PRECAUTIONS	20	Safety features	28
General safety instructions	20	Basic functions	28
Installation	23	Using the hob	28
Appliance purpose	24	Additional functions	29
This user manual	24	Error notifications	29
Manufacturer's liability	24	CLEANING AND MAINTENANCE	30
Identification plate	25	Cleaning the glass ceramic hob	30
Disposal	25	What to do if...	30
To save energy	25	INSTALLATION	31
How to read the user manual	25	Electrical connection	31
DESCRIPTION	26	Section cut from the countertop	32
General description	26	Mounting	32
Control panel	26	Ventilation	34
USE	27	Fastening to the built-in cabinet	34
Preliminary operations	27	Testing	35
		Instructions for the installer	35

We advise you to read this manual carefully, which contains all the instructions for maintaining the appliance's aesthetic and functional qualities. For further information on the product: www.smeg.com

PRECAUTIONS

General safety instructions

Risk of personal injury

- During use the appliance and its accessible parts become very hot. Keep children well away from the appliance.
- Protect hands with heat resistant gloves during use.
- Never try to put out a fire or flames with water: Turn off the appliance and smother the flames with a fire blanket or other appropriate cover.
- This appliance may only be used by children aged 8 years and over, and by people of reduced physical, sensory or mental capacity, or lacking in experience in the use of electrical appliances, provided that they are supervised or have been given instructions on the safe use of the appliance and of the hazards associated with it.
- Children must not play with the appliance.
- Keep children under the age of eight at a safe distance unless they are constantly supervised.
- Keep children under the age of 8 away from the appliance when it is in use.
- Cleaning and maintenance must not be carried out by unsupervised children.
- Be aware of how rapidly the cooking zones heat up. Do not place empty pans on the heat. Danger of overheating.
- Activate the controls lock when

you have children or pets which could reach the hob.

- Do not touch or clean the hob surface during operation or when the residual heat indicator lights are still on.
- After use, switch off the plates. Never rely solely on the cookware detector.
- Supervise children carefully as they cannot readily see the residual heat indication. After use the cooking zones remain hot for a certain period of time even if they have been turned off. Keep children away from the cooking zones.
- The cooking process must always be kept under control. A short cooking process must be continuously monitored.
- **WARNING:** Cooking foods containing fat and/or oil without monitoring them can be dangerous and can cause a fire.
- Fats and oils can catch fire if they overheat. Do not leave the appliance unattended while preparing foods containing oils or fats. If fats or oils catch fire, never put water on them. Place the lid on the pan and turn off the relevant cooking zone.
- Do not use the Booster and/or the Double Booster functions (if present) to heat fats or oils. Fire hazard.
- Do not place metal objects,

such as dishes or cutlery, on the surface of the hob during cooking as they may overheat.

- Do not cook foods in closed tins or containers or plastic containers.
- Do not use magnetic tins.
- Do not use trivets or other items between the bottom of the pan and the glass ceramic surface. Danger of burns.
- Do not insert pointed metal objects (cutlery or utensils) into the slots in the appliance.
- Do not use or store flammable materials near the appliance or directly underneath the hob.
- Switch off the appliance immediately after use.
- Do not pull the cable to unplug the appliance (if present).
- **DO NOT USE AEROSOLS IN THE VICINITY OF THIS APPLIANCE WHILST IT IS IN USE.**
- **DO NOT MODIFY THIS APPLIANCE.**
- Always wear personal protective equipment (PPE) before carrying out any work on the appliance (installation, maintenance, positioning or moving).
- Do not clean the appliance if it is still hot or in operation.
- After use the cooking zones remain hot for a certain period of time after they have been turned off. Do not touch the hob

surfaces.

- Before performing any work on the appliance, switch off the power supply.
- Do not try to repair the appliance yourself or without the assistance of a qualified technician.
- If the power cable becomes damaged, contact technical support immediately to arrange for it to be replaced in order to avoid possible hazards.
- If cracks or fissures form, or if the glass ceramic cooking surface breaks, turn off the appliance immediately. Disconnect the power supply and call Technical Support.
- People who have pacemakers or other similar devices fitted must make sure that the operation of these devices is not affected by the induction field, the frequency range of which is between 20 and 50 kHz.
- In conformity with the provisions regarding electromagnetic compatibility, the electromagnetic induction cooking hob comes under group 2 and class B (EN 55011).

Risk of damaging the appliance

- Do not use abrasive or corrosive detergents (e.g. scouring powders, stain

removers and metallic sponges) on glass parts.

- Use wooden or plastic utensils.
- Do not sit on the appliance.
- Do not use the glass ceramic cooking surface as a support surface.
- Do not use the appliance as a support surface.
- Do not obstruct ventilation openings and heat dispersal slots.
- Do not use the hob if the pyrolytic cycle is taking place inside any oven installed below.
- Do not use steam jets to clean the appliance.
- Never leave the appliance unattended during cooking operations where fats or oils could be released, as these could then heat up and catch fire. Be very careful.
- Fire hazard: Never leave objects on the cooking surfaces.
- DO NOT FOR ANY REASON USE THE APPLIANCE AS A SPACE HEATER.
- Cooking vessels or griddle plates should be placed inside the perimeter of the hob.
- All pans must have smooth, flat bottoms.
- If any liquid does boil over or spill, remove the excess from the hob.
- Take care not to spill acid

substances such as lemon juice or vinegar on the hob.

- Do not spill sugar or sweet mixtures on the hob during cooking.
- Do not place materials or substances that could melt or catch fire (paper, plastic or aluminium foil) on the appliance while it is in use.
- Place the cookware directly on the glass ceramic surface.
- Do not put empty pans or frying pans on switched on cooking zones.
- Do not use rough or abrasive materials or sharp metal scrapers.
- The glass ceramic surface is highly resistant to impact. However, prevent hard, solid objects from falling on the cooking surface as they may cause it to break.
- Do not use cleaning products containing chlorine, ammonia or bleach on parts made of steel or that have metallic surface finishes (e.g. anodizing, nickel- or chromium-plating).
- This appliance is not intended to be operated by means of external timer or separate remote control system.

Installation

- **THIS APPLIANCE MUST NOT BE INSTALLED IN BOATS OR CARAVANS.**
- This appliance must not be

installed on a dishwasher.

- Position the appliance into the cabinet cut-out with the help of a second person.
- Check that the carcass has the required openings.
- Check that the carcass material is heat resistant.
- Installation and servicing should be carried out by qualified personnel in accordance with current standards.
- Have the electrical connection performed by authorised technical personnel.
- The appliance must be connected to earth in compliance with electrical system safety standards.
- Use cables that can withstand temperatures of at least 90°C.
- Run the power cable in the rear part of the unit. Make sure that it does not come into contact with the lower part of the hob or a built-in oven below it.
- Be careful when connecting additional electrical appliances. Connection cables must not come into contact with hot cooking zones.
- The tightening torque of the screws of the terminal supply wires must be 1.2 - 1.5 Nm.
- Do not attach the appliance too tightly to the unit as this could cause damage during use or partially obstruct the heat dispersal slots.

- The power cable must only be installed or replaced by a qualified technician.
- If the power cable becomes damaged, contact technical support immediately to arrange for it to be replaced in order to avoid possible hazards.
- Always use any necessary/required personal protective equipment (PPE) before performing any work on the appliance (installation, maintenance, positioning or movement).
- Before performing any work on the appliance, switch off the power supply.
- Allow the appliance to be disconnected after installation, via an accessible plug or a switch in the case of a fixed connection.
- Fit the power line with an all-pole circuit breaker with a contact separation distance sufficient to provide complete disconnection in category III overvoltage conditions, pursuant to installation regulations.
- If the electrical supply is restricted, means of all-pole disconnection must be accessible and incorporated in the fixed wiring in accordance with the wiring rules.
- This appliance can be used up to a maximum altitude of 2,000

metres above sea level.

- Do not set the hob at a power higher than that supported by the electrical system.
- Do not set the hob at a power higher than that supported by the electrical system.

Appliance purpose

This appliance is intended for cooking food in the home environment. Every other use is considered inappropriate. It cannot be used:

- in employee kitchens, shops, offices and other working environments.
- in farms/farmhouses.
- by guests in hotels, motels and residential environments.
- In bed and breakfast accommodation.

This user manual

- This user manual is an integral part of the appliance and must therefore be kept in its entirety and within the user's reach for the whole working life of the appliance.
- Read this user manual carefully before using the appliance.
- The explanations in this manual include images, which describe all that regularly appears on the display. However, it should be kept in mind that the appliance may be equipped with an updated version of the system, and as such, all that appears on the display may differ from those in the manual.

Manufacturer's liability

The manufacturer declines all liability for damage to persons or property caused by:

- use of the appliance other than that specified;
- failure to comply with the instructions in the user manual;
- tampering with any part of the appliance;

- use of non-original spare parts.

Identification plate

The identification plate bears the technical data, serial number and brand name of the appliance. Do not remove the identification plate for any reason.

Disposal



This appliance conforms to the WEEE European directive (2012/19/EU) and must be disposed of separately from other waste at the end of its service life.

The appliance does not contain substances in quantities sufficient to be considered hazardous to health and the environment, in accordance with current European directives.



Power voltage Danger of electrocution

- Disconnect the mains power supply.
- Unplug the appliance.

To dispose of the appliance:

- Cut the power cable and remove it.
- Deliver the appliance to the appropriate recycling centre for electrical and electronic equipment waste, or return it to the retailer when purchasing an equivalent product, on a one for one basis.

Our appliances are packaged in non-polluting and recyclable materials.

- Deliver the packing materials to the appropriate recycling centre.



Plastic packaging Danger of suffocation

- Do not leave the packaging or any part of it unattended.
- Do not let children play with the plastic bags.

To save energy

- The diameter of the base of the pan must not extend beyond the lines printed on the glass ceramic surface.
- Pans must not be placed outside the perimeter of the hob or on the display.
- When buying a pan, check whether the diameter indicated is that of the base or the top of the pan, as the top is almost always larger than the base.

- When preparing dishes with long cooking times, you can save time and energy by using a pressure cooker, which also helps to retain vitamins contained in the food.
- Make sure that the pressure cooker contains enough liquid as, if there is not enough and it overheats, this may cause damage to both the pressure cooker and the cooking zone.
- If possible, always cover pans with a suitable lid.
- Choose a pan suitable for the quantity of food to be cooked. A large, half-empty saucepan leads to a waste of energy.



Under certain circumstances, if the hob and the oven are used at the same time, the maximum power limit of the electrical system might be exceeded.

How to read the user manual

This user manual uses the following reading conventions:



Warning/Caution



Information/Advice

DESCRIPTION

General description

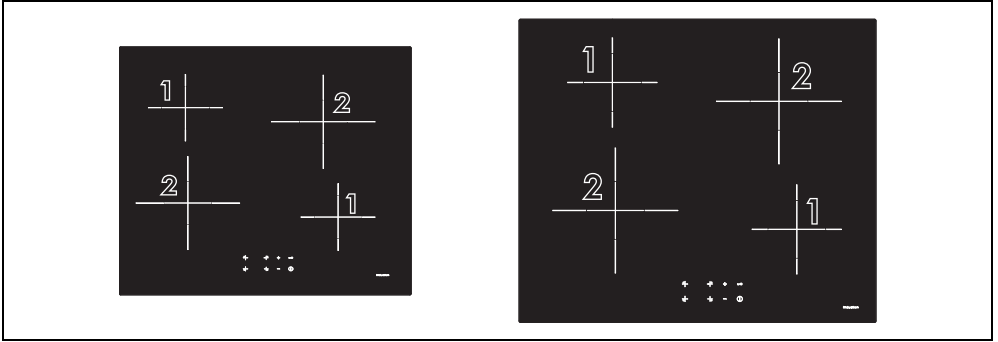

Zone	Dimensions H x L (mm)	Pan Ø minimum (mm)	Max. power draw (W)*	Power draw in booster function (W)*
1	150 x 150	90	1200	1600
2	210 x 210	130	1500	2000

*Power levels are approximate and may vary according to the pan used or the settings made.

Control panel

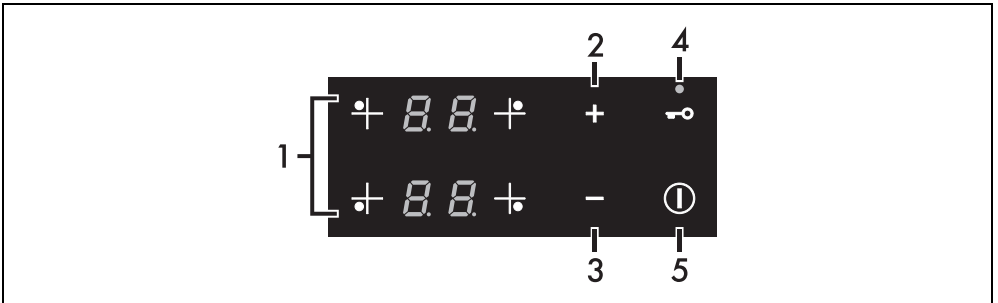

- 1 Cooking zones selection area
- 2 Value increase button
- 3 Value decrease button
- 4 Control lock button
- 5 ON/OFF button

Advantages of induction cooking



The appliance is equipped with an induction generator for each cooking zone. Each generator located under the glass ceramic cooking surface creates an electromagnetic field which induces a thermal current in the base of the pan. This means the heat is no longer transmitted from the hob to the pan but created directly inside the pan by the inductive current.

- Energy saving thanks to the direct transmission of energy to the pan (suitable magnetisable cookware is required) compared to traditional electric cooking.
- Improved safety as the energy is only

transmitted to the pan placed on the hob.

- High level of energy transmitted from the induction cooking zone to the base of the pan.
- Rapid heating speed.
- Reduced danger of burns as the cooking surface is only heated under the base of the pan; foods which overflow do not stick.

Power control

The hob is fitted with a power control module that optimises/limits consumption. If the overall set power level exceeds the maximum limit permitted, the electronic circuit board will

automatically manage the power supplied by the hot plates. The module tries to maintain the maximum deliverable power levels. If the  symbol appears it indicates that it is no longer possible to increase the power level for a specific cooking zone.



Priority is given to the first zone that is set in chronological order.



The power control module does not affect the total power consumption of the appliance.

USE

Preliminary operations



See General safety instructions.

- Remove any protective film from the outside or inside of the appliance, including any accessories (if present).
- Remove any labels (apart from the technical data plate).

Cookware suitable for use in induction cooking

Cookware used on the induction cooking surface must be made of metal, with magnetic properties and a sufficiently large base.

Suitable cookware:

- Enamelled steel cookware with thick bases.
- Cast iron cookware with an enamelled base.
- Cookware in multilayer stainless steel, ferritic stainless steel and aluminium with a special base.

Unsuitable cookware:

- Copper, stainless steel, aluminium, fireproof glass, wood, ceramic and terracotta cookware.

Advice on energy-saving

To see whether the pan is suitable, bring a magnet close to the bottom: if it is attracted, the pan is suitable for induction cooking. If you do not have a magnet, you can put a small amount of water in the pan, place it on a cooking zone and start the hot plate. If the  symbol

appears on the display, it means the pan is not suitable.

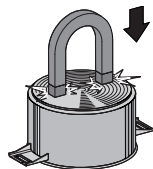

Advice on energy-saving

The diameter of the base of the pan must correspond to the diameter of the cooking zone.

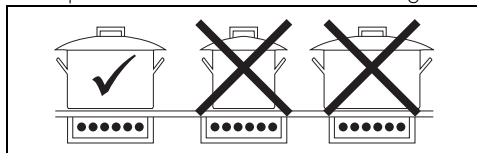

- When buying a pot, check whether the diameter indicated is that of the base or the top,
- as the top is almost always larger than the base.
- The base of the cookware must be thick and completely flat. In addition, the hob should be clean and dry as well.
 - When preparing dishes with long cooking times, you can save time and energy by using a pressure cooker, which also makes it possible to preserve the vitamins in the food.
 - Make sure that the pressure cooker contains enough liquid as, if there is not enough and it overheats, this may cause damage to both the pressure cooker and the cooking zone.
 - If possible, always cover the pans with a suitable lid.

- Choose a pan suitable for the quantity of food to be cooked. A large, half-empty saucepan leads to a waste of energy.
- Do not use cast-iron cookware or cookware with a rough base.





If hob and oven are being used at the same time, under certain conditions the maximum power limit that can be used by your electrical system might be exceeded.

Basic functions

First power connection

At the first power connection or after power has been switched back on after a power failure, an automatic control is carried out. This control turns on the indicator lights and the displays for a few seconds. After that, the controls lock function is activated automatically, signalled by the lighting up of controls lock indicator light. Press the  button for at least 2 seconds to switch on the appliance.



Switching on and off

Press the  button to turn the appliance on. To turn off the appliance, press the  button until three beeps sound.

Using the hob

Switching on the cooking zones



After switching on the display:

1. Select the cooking zone to be activated using the appropriate selection buttons (e.g.:  front right cooking zone).
2. Use the  and  buttons to select power levels from 1 to 9 or enable the Booster function.

Switching off the cooking zones

1. Select the cooking zone to deactivate.
2. Use the  button to reset the power level to 0 (zero).



- Hold the  button down for at least 2 seconds to switch off all cooking zones at the same time.
- A zone can be switched off quickly by pressing the  and  buttons at the same time.

If a vessel not suitable for induction cooking is used on an active zone or there is no vessel, the zone will not deliver power and its display will show the  symbol alternating with the power level number.

Booster function



See General safety instructions.

The Booster function allows you to heat a pan at maximum power for a limited amount of time. It

Safety features



See General safety instructions.

The hob has an automatic device which limits the duration of use. If the cooking zone settings are not changed, the maximum duration of operation for each zone depends on the power level selected. When the device for limiting the duration of use is activated, the cooking zone turns off, a short beep will be emitted and, if the zone is hot, the  symbol appears on the display.

Power level	Maximum cooking duration in hours
1 - 8	10
9	3



Power level table

The power in the cooking zones can be adjusted to various levels. In the table below you will find instructions for the different types of cooking.

Power level	Suitable for:
0	OFF setting
from 1 to 2	Cooking small amounts of food (minimum power)
from 3 to 4	Cooking
from 5 to 6	Cooking large quantities of food, roasting larger portions
from 7 to 8	Roasting, slow frying with flour
9	Roasting
P	Bring a large amount of water to the boil (maximum power, see "Booster function")

can be used to bring a large amount of water to the boil rapidly.

After selecting a zone:

1. Set the power level to 9.
2. Press the  button again; the  symbol



The Booster function remains active for a maximum of 10 minutes, after which the power level of the zone returns to 9.

will be shown on the display.

To deactivate the Booster function, simply decrease the power level of the cooking zone or switch off the appliance.

Additional functions

Timed cooking

This function is used to program the automatic switch-off of each cooking zone at the end of a period of time set by the user (from 1 to 99 minutes).



To set a timed cooking:

1. Select any cooking zone using the specific buttons.
2. Select a power level (from 1 to 9).





The timer cannot be activated if the power level of the selected zone is zero (0).

3. Press the select cooking zone button again; a beep will be emitted to confirm.

The  symbol will appear on the display of the selected zone, while  will appear on the displays of the adjacent zones.



If one of the front zones has been selected, the digits of the countdown will appear on the displays of the rear zones and vice versa.



4. Use the  and  buttons to select the minutes (pressing continuously allows you to advance quickly).
5. Press any select cooking zone button or wait 10 seconds to start the timer.

The display of the timed zone now shows the previously set power level with a dot at the lower right (e.g.: .

At the end of the timed cooking, the cooking zone is switched off, the display shows .

flashing and beeps are emitted. Press any button to stop the buzzer.



Modifying or deactivating timed cooking

1. Select a timed zone.
2. Press the zone selection button again to display the remaining time.
3. Use the  and  buttons to modify or reset the countdown. Resetting the countdown disables the timed cooking.

Controls lock

This function allows the buttons of the control panel to be locked. This function can be activated either when the unit is switched on or off.

To activate the controls lock when the appliance is switched on:

1. Press the  button for at least 1 second.
2. When the controls lock indicator light is switched on, the controls are locked (except for the  and  buttons).

To deactivate the controls lock, press the  button for at least 1 second and check that the indicator light above is off.



A power failure will not deactivate the controls lock.

Error notifications

If the appliance malfunctions or operates incorrectly, the code associated with the error appears on the displays of the cooking zones. Errors associated with overheating of the appliance or one of its parts can only be solved by allowing it to cool down and are coded as "C", "c" and "Fc".



Residual heat indicators are not to be considered as error codes.

If these errors persist or different errors appear, note down the code and contact Technical Support.

CLEANING AND MAINTENANCE

Cleaning the glass ceramic hob



See General safety instructions.

Cleaning the surfaces

To keep the surfaces in good condition, they should be cleaned regularly after use. Let them cool first.

Ordinary daily cleaning

Always and only use specific products that do not contain abrasives or chlorine-based acids. Pour the product onto a damp cloth and wipe the surface, rinse thoroughly and dry with a soft cloth or a microfibre cloth.



In case of stubborn dirt, clean when cold using a damp kitchen sponge and neutral detergent; then dry with a microfibre cloth.

Weekly cleaning

Clean and maintain the hob once a week using an ordinary glass ceramic cleaning product. Always follow the manufacturer's instructions. The silicon in these products creates a protective, water-repellent membrane which also resists dirt. All marks stay on the membrane and can therefore be removed easily. After cleaning, dry the surface with a clean cloth. Make sure that there is no detergent left on the cooking surface as it might undergo an aggressive reaction when heated up and could modify the structure of the cooking surface.

Food stains or residues

Light coloured marks from pans with aluminium bases can be easily cleaned off with a cloth moistened in vinegar. Remove any burnt-on residues after cooking; then rinse with water and dry thoroughly with a clean cloth. Dirt, which may have fallen on the hob while cleaning lettuce or potatoes, can scratch the hob when moving pans. Consequently, remove any dirt from the cooking surface immediately. Changes in colour do not affect the operation and stability of the glass. These are not alterations to the material of the hob but just residues which have not been removed and have then carbonised. Shiny surfaces can form due to the bases of pans, especially aluminium ones, rubbing on the surface, and due to the use of

unsuitable detergents. They are difficult to remove using conventional cleaning products. It may be necessary to repeat the cleaning process several times. Use of corrosive detergents or rubbing of pan bases can wear away the decoration on the hob over time and contribute to the formation of stains.



We recommend the use of cleaning products distributed by the manufacturer.



After cleaning, dry the appliance thoroughly to prevent any water or detergent from interfering with its operation or creating unsightly marks.

What to do if...

The hob does not work:

- Make sure that the hob is connected and that the main switch is turned on.
- Make sure that there is no power failure.
- Make sure that the fuse has not blown. In this case replace the fuse.
- Make sure that the circuit breaker of the residential electrical system has not tripped. In this case, reset the circuit breaker.

The cooking results are unsatisfactory:

- Make sure that the cooking temperature is not too high or too low.
- Make sure that the hob is properly ventilated and that the air inlets are unobstructed.
- Use cookware that is certified and tested for induction cooking.

The hob smokes:

- Let the hob cool down and clean it once cooking is complete.
- Make sure that the food has not spilled out of the pan and use a larger cooking vessel, if needed.

The fuses blow or the circuit breaker of the residential electrical system trips repeatedly.

- Call Technical Support or an electrician.

There are cracks or fissures in the hob:

- Turn off the appliance immediately, disconnect the power supply and contact Technical Support.

INSTALLATION

Electrical connection



See General safety instructions.

General information

Check the mains characteristics against the data indicated on the plate.

The identification plate bearing the technical data, serial number and brand name is visibly positioned on the appliance.

Do not remove this plate for any reason.

The appliance must be connected to ground using a wire that is at least 20 mm longer than the other wires.

The appliance can work in the following modes:

380-415 V 3N~

5 x 2.5 mm²

five-core cable

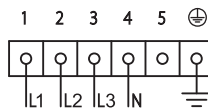

220-240 V 1N~

3 x 4 mm²

three-core cable

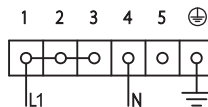

The diagram below illustrates the terminal from below, with no cables connected.

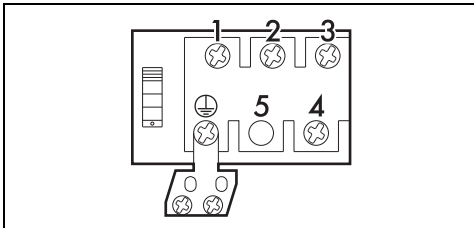

The values indicated refer to the cross-section of the internal conductor.



The aforementioned power cables are sized taking into account the coincidence factor (in compliance with standard EN 60335-2-6).



Use the supplied jumper for each connection, if any

Fixed connection

Fit the power line with an all-pole circuit breaker with a contact separation distance sufficient to

provide complete disconnection in category III overvoltage conditions, pursuant to installation regulations.

For the Australian/New Zealand market:

The circuit breaker incorporated in the fixed connection must comply with AS/NZS 3000.

Setting the power level of the appliance



- This function allows you to set the maximum power limit for your appliance.
- The appliance is factory set to a maximum power of 7.2 kW, but can be regulated to operate at 6.0, 3.5 and 2.8, 2.2, 1.6 and 1.0 kW.

The following procedure can be used to adjust the maximum power from 7.2 to 2.8 kW (high power regime):

- Switch off all the plates before proceeding.
- Disconnect the appliance from the mains power supply.
- Reconnect the appliance to the mains power supply.

Carry out the following procedure within 30 seconds of the appliance being reconnected:



- Press and hold the button to unlock the controls.
- Press the and buttons at the same time.
 - A beep will be emitted and the current power level will be shown on the display.







- Use the and buttons to change the value.
 - Press the and buttons at the same time to save the new power value. The appliance will switch off and you will have to switch it on again in order to use it with the new power limits.
 - If you do not wish to save the changes, simply do not use the display for at least 60 seconds.

The following procedure can be used to adjust the maximum power from 2.8 to 1.0 kW (low

power regime):

1. Follow the instructions in point 4 above.
2. Press the  and  buttons at the same time.
 - A beep will be emitted and the current power level will be shown on the display.



3. Use the  and  buttons to change the value.
 - Press the  and  buttons at the same time to save the new power value. The appliance will switch off and you will have to switch it on again in order to use it with the new power limits.
 - If you do not wish to save the changes, simply do not use the display for at least 60 seconds.

Section cut from the countertop

Safety instructions for positioning and installation



See General safety instructions.

- Installation can be carried out on various materials such as masonry, metal, solid wood or plastic laminated wood as long as they are heat resistant ($>90^{\circ}\text{C}$).
- Veneers, adhesives or plastic coatings on adjacent furniture should be temperature-resistant ($>90^{\circ}\text{C}$), otherwise they might warp over time.
- If the piece of furniture does not have the required recess opening, either it will have to be cut or masonry work carried out by a competent technician.
- The minimum clearance between exhaust hoods and the cooking surface must be at least the distance indicated in the exhaust hood installation instructions.
- The minimum clearances must also be respected for the edges of the hob on the back as indicated in the assembly instructions.
- If the appliance is to be installed above an oven, the oven must be fitted with a cooling fan.

Appliance overall dimensions (mm)

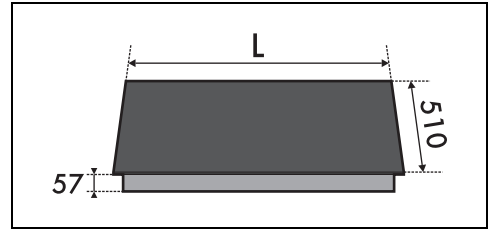

Mounting

On top of oven built-in unit

The clearance between the hob and the kitchen furniture or other installed appliances must be enough to ensure sufficient ventilation and air discharge. If installed above an oven, a space must be left between the bottom of the hob and the top of the appliance installed below.

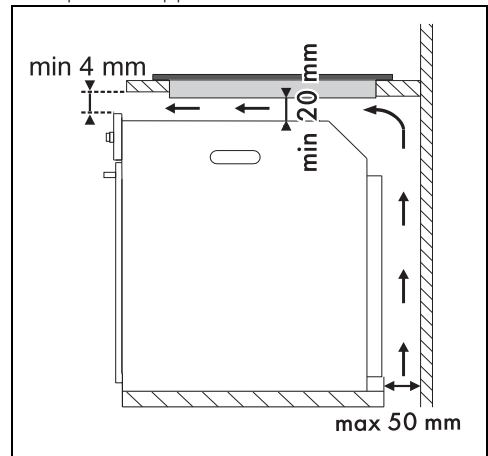

On top of empty kitchen unit or drawers

If there are other pieces of furniture (lateral walls, drawers, etc.), dishwashers or fridges under the hob, a double-layer wooden base must be installed at least 20 mm from the bottom of the hob to avoid any accidental contact. It must only be possible to remove the double-layer

base using suitable equipment.

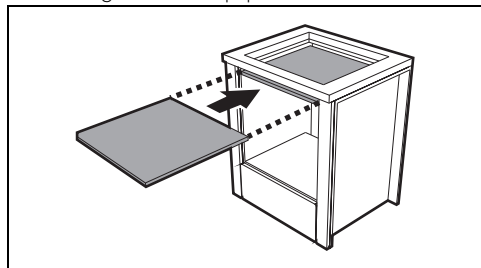

opens on bottom:

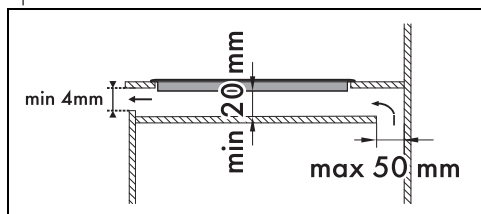

opens on rear:

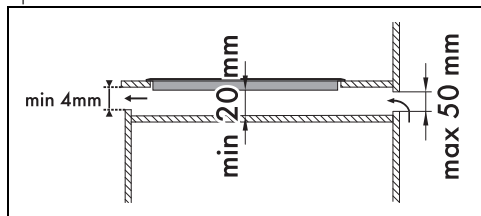

Failure to install the double-layer wooden base exposes the user to possible accidental contact with sharp or hot parts.



If installed on top of an oven, the latter must be equipped with a cooling fan.

On an empty kitchen

If there are other pieces of furniture under the hob, a double-layer wooden base must be installed at least 20 mm from the bottom of the hob to avoid any accidental contact. It must only be possible to remove the double-layer

base using suitable equipment.

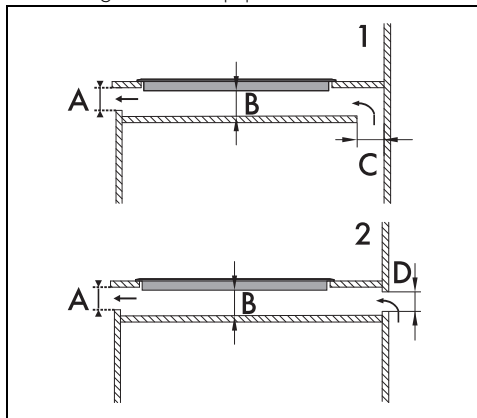

1 Opens on bottom

2 Opens on back

A min. 5 mm

B min., 20 mm

C min. 30 mm - max. 50 mm

D min. 30 mm - max. 50 mm



Failure to install the double-layer wooden base exposes the user to possible accidental contact with sharp or hot parts.

Flush mounting (mm)

For this type of mounting, you have to make an additional cut at the edges of the recess in the furniture if you wish to install the hob flush with the countertop.

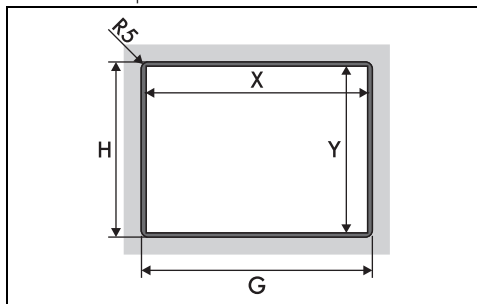

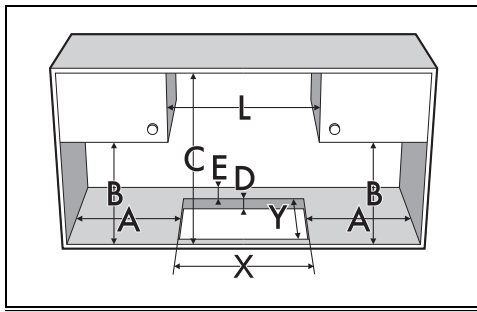

A	B	C	D	E
min 150	min 460	min 750	30 - 50	min 50

L	X	Y	G	H
600-700	596	510	604	514

Standard mounting (mm)

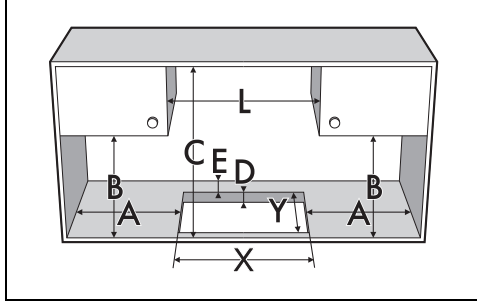

A	B	C	D	E
min 150	min 460	min 750	30 - 50	min 50

L	X	Y
600-700	560	482

Hob seal

To prevent leakage of liquid between the frame of the hob and the countertop, place the adhesive seal provided along the entire outer edge of the hob before assembly.

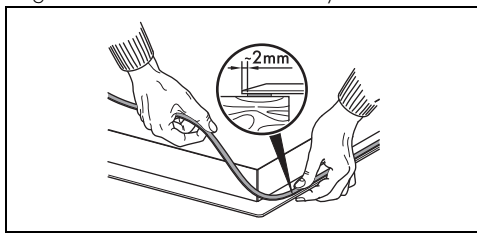

! Do not use silicone to secure the hob. This would make it impossible to remove the hob without damaging it.

In the case of flush mounting, after placing the adhesive seal (A) on the glass surface and after positioning and securing the hob, fill the edges with insulating silicone (B) and wipe off any excess. If for any reason the hob needs to be removed, cut the silicone using a cutter before attempting to remove it (C).

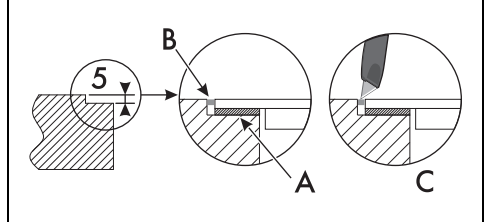

Ventilation

The illustrations below show two examples of installation suitable for proper ventilation and one example of incorrect installation to be avoided.

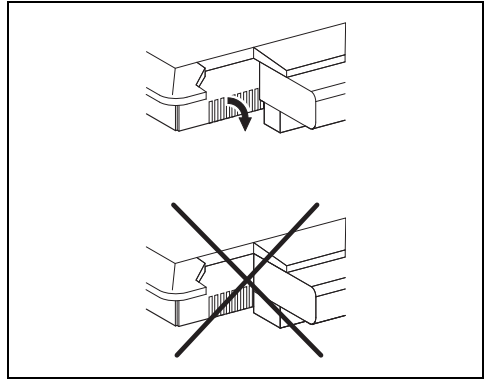

Fastening to the built-in cabinet

It has to be secured to the cabinet using front and back screws:

1. Remove the screws from the holes indicated in the figure below.

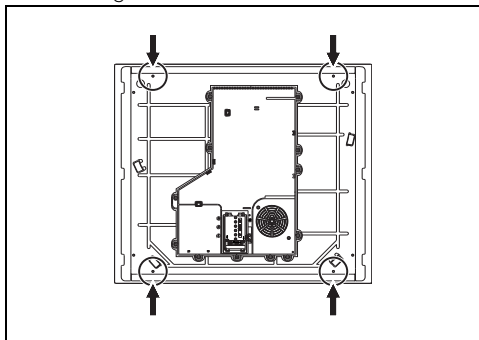

2. Fasten the fixing brackets (A) into the holes marked using the screws that were removed in order to correctly fix the hob to the structure.

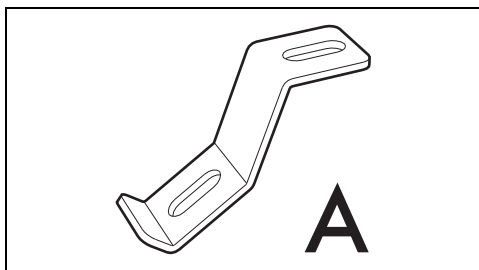

 If tightened too much the glass may be strained and crack.

The fixing brackets should be installed differently according to the thickness of the countertop.

- Countertop thickness 30 mm:

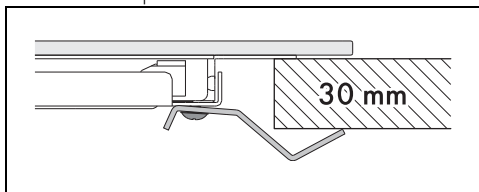

- Countertop thickness 40 mm:

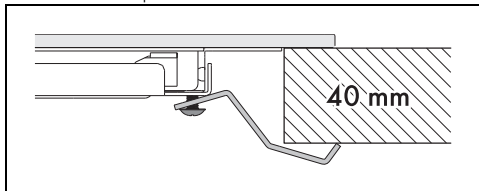

- Countertop thickness 50 mm:

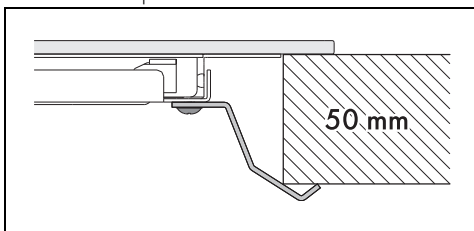

 In the case of countertops of less than 30 mm, an additional spacer should be used between the bracket and the top.

Testing

At the end of installation, carry out a brief inspection test. If it fails to work, after making sure that you have carried out the instructions correctly, contact Technical Support.

Instructions for the installer

- If you use a plug (if present) to connect to the power supply, the plug must be accessible after installation.
- Do not bend or trap the power cable.
- The appliance must be installed according to the installation diagrams.
- If the appliance does not work correctly after having carried out all the checks, contact your local Authorised Service Centre.
- Once the appliance has been installed, please explain to the user how to use it correctly.