

PRECAUTIONS	22	Basic functions	29
General safety instructions	22	Using the hob	29
Installation	25	Additional functions	31
Appliance purpose	26	Safety functions	32
This user manual	26	CLEANING AND MAINTENANCE	34
Manufacturer's liability	26	Cleaning the glass ceramic hob	34
Identification plate	26	What to do if...	34
Disposal	26	INSTALLATION	35
To save energy	27	Electrical connection	35
How to read the user manual	27	Power limitation procedure	36
DESCRIPTION	27	Section cut from the countertop	36
Control panel	28	Mounting	38
USE	29	Fixing to the built-in cabinet	39
Preliminary operations	29	Fixing to the built-in cabinet	39
		Instructions for the installer	39

We advise you to read this manual carefully, which contains all the instructions for maintaining the appliance's aesthetic and functional qualities. For further information on the product: www.smeg.com

PRECAUTIONS

General safety instructions

Risk of personal injury

- During use the appliance and its accessible parts become very hot. Keep children well away from the appliance.
- The appliance becomes very hot during use. Take care never to touch the heating elements.
- Protect your hands by using oven gloves when handling hot pans.
- Never try to put out a fire or flames with water: turn off the appliance and smother the flames with a fire blanket or other appropriate cover.
- This appliance may only be used by children aged 8 years and over, and by people of reduced physical, sensory or mental capacity, or lacking in experience in the use of electrical appliances, provided that they are supervised or have been given instructions on the safe use of the appliance and of the hazards associated with it.
- Children must not play with the appliance.
- Keep children below the age of 8 away from the appliance unless they are constantly supervised.
- Keep children under the age of 8 away from the appliance when it is in use.
- Cleaning and maintenance must not be carried out by unsupervised children.
- Be aware of how rapidly the cooking zones heat up. Do not

- place empty pans on the heat.
Danger of overheating.
- After use the cooking zones remain hot for a certain period of time after they have been turned off. Do not touch the hob surfaces.
 - The cooking process must always kept under control. A short cooking process must be continuously monitored.
 - **WARNING:** Leaving food that contains fat and/ oil unattended when cooking can be dangerous and can cause a fire. **DO NOT** attempt to extinguish a fire with water. Turn off the appliance and smother the flames, for example with a lid or a blanket.
 - Do not use the Booster and/or the Double Booster functions (if present) to heat fats or oils. Fire hazard.
 - Do not place metal objects, such as dishes or cutlery, on the surface of the hob during cooking as they may overheat.
 - Do not cook foods in closed tins or containers or plastic containers.
 - Do not insert pointed metal objects (cutlery or utensils) into the slots in the appliance.
 - Do not use or store flammable materials near the appliance.
 - Do not pour water directly onto very hot trays.
 - If you need to move food or at the end of cooking, open the door 5 cm for a few seconds, let the steam come out, then open it fully.
 - Switch off the appliance immediately after use.
 - Do not pull the cable to unplug the appliance (if present).
 - **DO NOT USE OR STORE FLAMMABLE MATERIALS IN THE STORAGE COMPARTMENT (IF AVAILABLE) OR NEAR THE APPLIANCE.**
 - **DO NOT USE AEROSOLS IN THE VICINITY OF THIS APPLIANCE WHILST IT IS IN USE.**
 - **DO NOT MODIFY THIS APPLIANCE.**
 - Always wear personal protective equipment (PPE) before carrying out any work on the appliance (installation, maintenance, positioning or moving).
 - Do not clean the appliance if it is still hot or in operation.
 - Before performing any work on the appliance, switch off the power supply.
 - **WARNING:** Make sure that the appliance has been switched off and disconnected from the mains power supply or that the mains power has been switched off before replacing the interior lighting bulbs.
 - The bulbs used in this

appliance are specific for household appliances; do not use them for home lighting.

- Do not try to repair the appliance yourself or without the assistance of a qualified technician.
- Installation and servicing should be carried out by qualified personnel in accordance with current standards.
- If the power cable becomes damaged, contact technical support immediately to arrange for it to be replaced in order to avoid possible hazards.
- If cracks or fissures form, or if the glass ceramic cooking surface breaks, turn off the appliance immediately. Disconnect the power supply and call Technical Support.
- Do not touch or clean the hob surface during operation or when the residual heat indicator lights are still on.
- Activate the controls lock when you have children or pets that could reach the hob.
- Supervise children carefully as they cannot readily see the indication of residual heat. After use the cooking zones remain hot for a certain period of time even if they have been turned off. Keep children away from the cooking zones.
- The appliance is not intended to operate with external timers

or remote-control systems.

- **WARNING:** Only use a protective shield designed by the manufacturer of the cooking appliance. The use of inadequate protective shields can lead to accidents.

Risk of damaging the appliance

- Do not use harsh or abrasive detergents or sharp metal scrapers to clean the glass door of the oven since they may scratch the surface and cause the glass to shatter.
- Use wooden or plastic utensils.
- Do not use steam jets to clean the appliance.
- Do not use the appliance as a support surface.
- Do not obstruct ventilation openings and heat dispersal slots.
- Do not sit on the appliance.
- Never leave the appliance unattended during cooking operations that could lead to oils and fats overheating and catching fire. Be very careful
- Risk of fire: Do not store objects on the cooking surfaces.
- Do not spray any product near the appliance.
- **DO NOT FOR ANY REASON USE THE APPLIANCE AS A SPACE HEATER.**
- Do not use plastic kitchenware or containers for cooking.
- Cooking vessels or griddle

- plates should be placed inside the perimeter of the hob.
- All pans must have smooth, flat bottoms.
 - If any liquid does boil over or spill, remove the excess from the hob.
 - Take care not to spill acid substances such as lemon juice or vinegar on the hob.
 - Do not spill sugar or sweet mixtures on the hob during cooking.
 - Do not place materials or substances that could melt or catch fire (paper, plastic or aluminium foil) on the appliance while it is in use.
 - Do not use steam jets to clean the appliance.
 - Place the cookware directly on the glass ceramic surface.
 - Do not put empty pans or frying pans on switched on cooking zones.
 - Do not use rough or abrasive materials or sharp metal scrapers.
 - Do not use cleaning products containing chlorine, ammonia or bleach on parts made of steel or that have metallic surface finishes (e.g. anodizing, nickel- or chromium-plating).
 - Do not use abrasive or corrosive detergents (e.g. scouring powders, stain removers and metallic sponges) on glass parts.
 - The glass ceramic surface is highly resistant to impacts. However, avoid hard, solid objects falling on the cooking surface as they may cause it to break.
 - Keep sensor buttons clean at all times and do not place any object on them.
- ### Installation
- **THIS APPLIANCE MUST NOT BE INSTALLED IN A BOAT OR CARAVAN.**
 - This appliance must not be installed on a pedestal.
 - Always use any necessary/required personal protective equipment (PPE) before performing any work on the appliance (installation, maintenance, positioning or movement).
 - Check that the cabinet has the required slots.
 - Check that the cabinet material is heat resistant.
 - Installation and servicing should be carried out by qualified personnel in accordance with current standards.
 - Have the electrical connection performed by authorised technical personnel.
 - The appliance must be connected to earth in compliance with electrical system safety standards.
 - Use cables withstanding a temperature of at least 90 °C.

- The tightening torque of the screws of the terminal supply wires must be 1.5 - 2 Nm.
- Be careful when connecting additional electrical appliances. Connection cables must not come into contact with hot cooking zones.
- The power cable must only be installed or replaced by a qualified technician.
- Allow the appliance to be disconnected after installation, via an accessible plug or a switch in the case of a fixed connection.
- Fit the power line with an all-pole circuit breaker with a contact separation distance sufficient to provide complete disconnection in category III overvoltage conditions, pursuant to installation regulations.
- This appliance can be used up to a maximum altitude of 2,000 metres above sea level.

Appliance purpose

This appliance is intended for cooking food in the home environment. Every other use is considered inappropriate. It cannot be used:

- in employee kitchens, shops, offices and other working environments.
- in farms/farmhouses.
- by guests in hotels, motels and residential environments.

- In bed and breakfast accommodation.

This user manual

- This user manual is an integral part of the appliance and must therefore be kept in its entirety and within the user's reach for the whole working life of the appliance.
- Read this user manual carefully before using the appliance.
- The explanations in this manual include images, which describe all that regularly appears on the display. However, it should be kept in mind that the appliance may be equipped with an updated version of the system, and as such, all that appears on the display may differ from those in the manual.

Manufacturer's liability

The manufacturer declines all liability for damage to persons or property caused by:

- use of the appliance other than that specified;
- failure to comply with the instructions in the user manual;
- tampering with any part of the appliance;
- use of non-original spare parts.

Identification plate

The identification plate bears the technical data, serial number and brand name of the appliance. Do not remove the identification plate for any reason.

Disposal



This appliance conforms to the WEEE European directive (2012/19/EU) and must be disposed of separately from other waste at the end of its service life.

The appliance does not contain substances in quantities sufficient to be considered hazardous to health and the environment, in accordance with current European directives.



Power voltage
Danger of electrocution

- Disconnect the mains power supply.
- Unplug the appliance.

To dispose of the appliance:

- Cut the power cable and remove it.
- Deliver the appliance to the appropriate recycling centre for electrical and electronic

equipment waste, or return it to the retailer when purchasing an equivalent product, on a one for one basis.

Our appliances are packaged in non-polluting and recyclable materials.

- Deliver the packing materials to the appropriate recycling centre.



**Plastic packaging
Danger of suffocation**

- Do not leave the packaging or any part of it unattended.
- Do not let children play with the plastic bags.

To save energy

- The diameter of the base of the pan must not extend beyond the lines printed on the glass ceramic surface.
- Pans must not be placed outside the perimeter of the hob or on the display.
- When buying a pan, check whether the diameter indicated is that of the base or the top of the pan, as the top is almost always larger than the base.
- When preparing dishes with long cooking

times, you can save time and energy by using a pressure cooker, which also helps to retain vitamins contained in the food.

- Make sure that the pressure cooker contains enough liquid as, if there is not enough and it overheats, this may cause damage to both the pressure cooker and the cooking zone.
- If possible, always cover pans with a suitable lid.
- Choose a pan suitable for the quantity of food to be cooked. A large, half-empty saucepan leads to a waste of energy.



Under certain circumstances, if the hob and the oven are used at the same time, the maximum power limit of the electrical system might be exceeded.

How to read the user manual

This user manual uses the following reading conventions:



Warning/Caution



Information/Advice

DESCRIPTION

General description

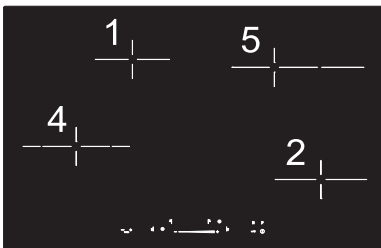
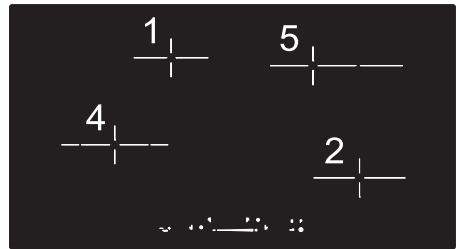
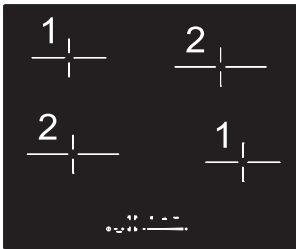

Zone	Dimensions H x L (mm)	Power consumption at lev.9 (W) *	Inside diameter (mm)	Middle diameter (mm)	Power draw in booster function (W) *
1	150 x 150	900	-	-	1200
2	185 x 185	1350	-	-	1800
3	200 x 200	960	-	-	1200
4	215 x 215	1650	135	-	2200
5	oval plate	1650	-	-	2200
6	288 x 288	2160	150	216	2700
7	185 x 185	1500	124	-	2000

*Power levels are approximate and may vary according to the pan used or the settings made.

Control panel

Cooking zones area

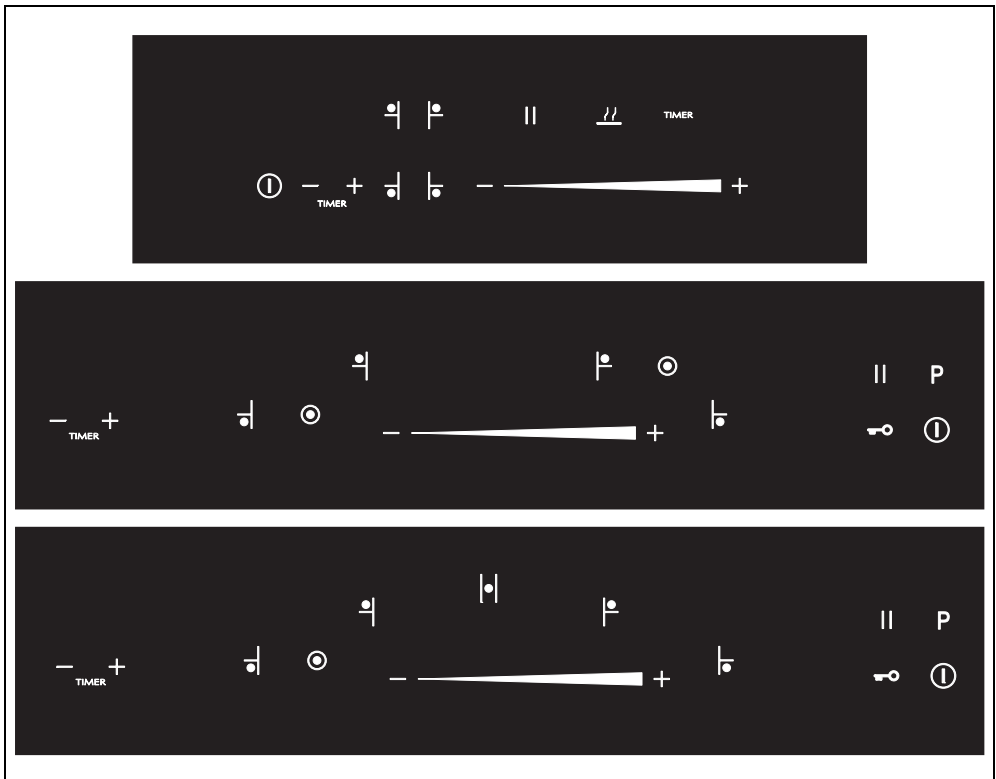

Symbols



ON/OFF key

Turns the hob on or off.



Control lock button

Activates or deactivates the controls lock if pressed for 1 second.



Pause key

It pauses all hob functions.



Booster key

Activates the Booster function.

**Increase key**

Increases the power level or cooking time.

**Decrease key**

Reduces the power level or cooking time.

**Timer key**

Activates the timer for the automatic shutdown/minder function.

**Multiple zone key**

Enables the multiple cooking zone of the multi-zone hobs to be switched on.

**Warm/melt key**

Activates the keep warm function.

**Scroll bar key**

Increases or decreases the power level of a cooking zone.

Cooking zones

Front left



Rear left



Central



Rear right



Front right

USE

Preliminary operations



See General safety instructions.

- Remove any protective film from the outside or inside of the appliance, including any accessories (if present).
- Remove any labels (apart from the technical data plate).

Basic functions

First power connection

When connected to the power supply for the first time, or after power has been switched back on after a power failure, an automatic check is carried out that control turns on the indicator lights and the displays for a few seconds. Afterwards, the appliance can be used normally.

Switching on and off

To switch on the hob, hold down the **ON/OFF**



key for 1 second.

If no cooking zone is activated within 5 seconds of switching on, the hob switches off automatically.

Using the hob

Switching the cooking zones on

1. After switching the hob on, all displays show the symbol .
2. Select the wished cooking zone.
3. Press the Increase and Decrease keys to increase or decrease the required power level.



When the cooking zone is off (), it cannot be activated by pressing the Decrease key .

Switching on the double/triple cooking zone (on some models only)

1. After selecting a zone and pressing the multiple zone key an additional cooking zone will be activated, if any. On the display, a lighted dot comes on beside the power setting to indicate that the double cooking zone has switched on.
2. Pressing the multiple zone key a second time will activate an additional cooking zone, if any.

Adjusting the cooking zones

After placing a pan and ensuring that the zone has been activated:

1. Place a finger on the left-hand side of the scroll bar of the cooking zone to be used.

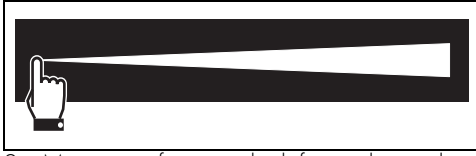

2. Move your finger to the left or right to select the power level from 1 to 9, or activate the Booster function (see dedicated chapter).

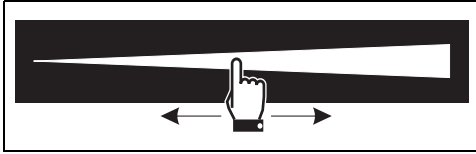

The display of the zone being used will indicate the selected power level.



The power level can also be selected by directly pressing the scroll bar, approximately at the point corresponding to the desired power level.

Switching the cooking zones off

1. Move your finger all the way to the left on the scroll bar of the cooking zone you wish to turn off.

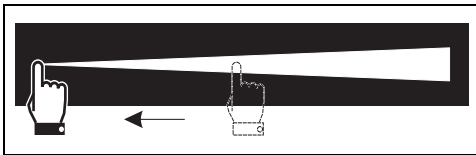

2. The display of the selected zone indicates



To switch off more than one cooking zone at the same time, simply switch the appliance off using the key .

Summary table of power levels

The power can be adjusted to various levels. The table below shows the levels suitable for

various types of cooking.

Power level	Suitable for:
0	OFF setting
1 to 2	Cooking small quantities of food (minimum power)
3 to 4	Cooking
5 to 6	Cooking large quantities of food, roasting larger portions
7 to 8	Roasting, slow frying with flour
9	Roasting
	Bringing large quantities of water to a boil (maximum power, see "Booster function")

Booster function

The booster function allows a pan to be heated to maximum capacity for a limited time. Useful for bringing large quantities of water to the boil in a short time.



In 60 cm models

After switching on the hob and having selected a zone:

1. Slide your finger to the right, after power level 9, the Booster function will be automatically activated.
2. The symbol  will appear in the display of the selected zone.



In 80/90 cm models

After switching on the hob and having selected a zone:

1. Select key .
2. The Booster function will be activated and the  symbol appears on the cooking zone display.
3. The power bar will go to maximum.

To deactivate the Booster function, simply decrease the power level of the cooking zone or switch the appliance off.





If the  key from the scroll bar is pressed while the booster function is active,  will flash in the display of the selected zone. The function will remain active.

Warming/melting function (60 cm models only)

The warming function allows you to keep cooked food warm or to keep water on the boil. The melting function allows food to be melted.

To activate these functions, press the  key.

- Press once to activate the keep warm function. The cooking zone display shows the symbol .
- Press a second time to activate the melting function. The zone display shows the symbol .



The warming function automatically switches off after 5 hours of use and switches off the cooking zone used.









The melting function automatically switches off after 2 hours of use and switches off the cooking zone being used.

Additional functions

Minute minder timer





This function is used to set a timer which will sound a buzzer at the end of the set time. It does not stop the operation of the cooking zones but rather informs the user when the set minutes have run out.

After having switched on the hob, without having activated any cooking zone:

1. Press the keys  and  at the same time;
2. The timer display shows .
3. Use the keys  and  to select the desired time; press and hold the keys for fast forward.
4. After a few moments, the timer starts counting down and the dot between the first and second digit flashes.
5. When the time elapses, a series of beeps will sound. Press the key  or  to deactivate them.

Modifying and deactivating the minute minder timer

To modify or deactivate the timer during the countdown:

1. Press the button  to switch the hob on (if it is off or in stand-by).
2. Press the keys  and  at the same time.
3. Use the keys  and  to change the countdown or to reset the timer. Resetting the timer results in its deactivation.





A maximum of 1 hours and 39 minutes can be set for the timer.



In the 60 model, it is set via a specific timer key on the right-hand side of the controls.

Timed cooking

This function is used to program the automatic switch-off of each cooking zone at the end of a period of time set by the user.

1. Place a pan on a cooking zone and select a zone power level.
2. Use the keys  and  to select the desired time; press and hold for fast forward.
3. Above the text **TIMER** the flashing symbol  is displayed.
4. Timed cooking will start 5 seconds after the last key has been pressed.
5. The display stops flashing.
6. When the time expires, the relevant zone is automatically switched off, the timer and zone displays flash.





- This function can be activated on multiple cooking zones at the same time.
- For each timed cooking zone, a red LED will light up next to the timer digits.
- When several timers are set, the display of the timer that will expire first will be shown.



A maximum of 1 hours and 39 minutes can be set for the timer.

Modifying or deactivating timed cooking

To change or reset a timed cooking, select the relevant zone and:

1. Reset with the timer key .
2. Press the timer keys  and  at the same time.

Rapid heating



This function is not available for the Booster function.

This function heats a cooking zone to maximum power and allows it to reach the heat corresponding to the selected power level more quickly.

After selecting a cooking zone:



1. Press and hold the scroll bar on the desired power level (1 to 9) for at least 3 seconds.
2. The zone display shows the symbol  alternating with the selected power level.
3. After the heating time has elapsed, the cooking zone reverts to the previously selected power level.

This function can be deactivated by selecting a different power level or by switching off the appliance.

Pause function

This function pauses the operation of all the cooking zones.

To activate the Pause function:

1. With at least one cooking zone active, press the key .
2.  appears on the displays of all the cooking zones.
3. All keys will be locked,



The Pause function can be maintained for a maximum of 10 minutes, after which the appliance switches off.

To deactivate the Pause function:

1. Press the key .
2. A sound will signal the end of the function.
3. The Pause function has now been deactivated and the previously set functions are restored.



The cooking time limitation, the residual heat indicators and the Control Lock function remain enabled during the Pause function.

Safety functions



See General safety instructions.

Limiting the cooking duration

The appliance has an automatic device which limits the duration of use.

If the cooking zone settings of the pan are not changed, the maximum duration of operation depends on the power level selected.

When the time limitation device is activated, the heating of the pan is switched off.

Power level	Maximum cooking duration in hours
1	10
2	5
3	5
4	4
5	3
6	2
7	2
8	2
9	1
P	10 min

Residual heat indicators (on some models only)

After the cooking zone has been switched off, each display shows a specific symbol /

 indicating whether the zone is still hot. It will flash if another zone is being used.

Protection from overheating

If the hob is used on full power for a long period, the electronics will have trouble cooling down if the room temperature is high.

When certain safety thresholds are reached, one or more cooking zones are switched off. If the internal temperature is very high, the appliance is switched off automatically.

Controls lock

In 80/90 cm models





This function is designed to lock all hob keys.

It is always active when the hob is switched on.

It locks every other key except itself and the ON/OFF key .

This function is useful when cleaning the appliance and to prevent accidental interactions.



To activate the controls block, with at least one cooking zone active:

1. Press the  key for at least one second.
2. A buzzer will sound to confirm that the function has been activated.
3. If another key is pressed, a buzzer will sound and the symbol  will appear on the display.



To deactivate the controls lock, press the  key for at least one second.





If a key is pressed for 5 seconds, an alarm sounds, if it is pressed for a further 5 seconds, the hob switches off

automatically and the symbols  and  are shown alternately on all cooking zones displays.



If a key is pressed for 30 seconds with the hob switched off, the symbols  and  are shown alternately.

In 60 cm models

1. Press the ON/OFF  key for 3 seconds.
2. The symbol  is shown to indicate that the function is active.
3. Press the ON/OFF  key for 3 seconds to deactivate the function.



Switches the hob off to prevent accidental switching-on while cleaning.

Advice on energy-saving

The diameter of the base of the pan must

correspond to the diameter of the cooking zone.

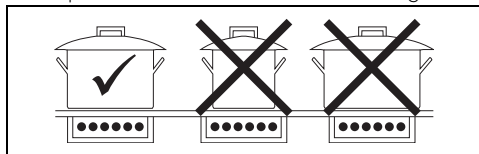

- When buying a pot, check whether the diameter indicated is that of the base or the top, as the top is almost always larger than the base.
- The base of the cookware must be thick and completely flat. In addition, the hob should be clean and dry as well.
- When preparing dishes with long cooking times, you can save time and energy by using a pressure cooker, which also makes it possible to preserve the vitamins in the food.
- Make sure that the pressure cooker contains enough liquid as, if there is not enough and it overheats, this may cause damage to both the pressure cooker and the cooking zone.
- If possible, always cover the pans with a suitable lid.
- Choose a pan suitable for the quantity of food to be cooked. A large, half-empty saucepan leads to a waste of energy.
- Do not use cast-iron cookware or cookware with a rough base.



If hob and oven are being used at the same time, under certain conditions the maximum power limit that can be used by your electrical system might be exceeded.

Error warnings

In the event of a malfunction or abnormal operation, the display shows a message containing the code associated with the error. Error codes always begin with the letter "F" followed by a digit or letter (e.g. "Ft or F4").

Errors coded as:

- "Fc"
- "Ft"
- "FE"

Indicate an overheating of the appliance or part of it, so the appliance must be switched off immediately, all pans removed and allowed to cool down.

If these errors persist or different ones are displayed, the code should be noted and the

Technical Support should be contacted.



Residual heat indicators are not to be considered as error codes.

CLEANING AND MAINTENANCE

Cleaning the glass ceramic hob



See General safety instructions.

Cleaning the surfaces

To keep the surfaces in good condition, they should be cleaned regularly after use. Let them cool first.

Ordinary daily cleaning

Always and only use specific products that do not contain abrasives or chlorine-based acids. Pour the product onto a damp cloth and wipe the surface, rinse thoroughly and dry with a soft cloth or a microfibre cloth.



In case of stubborn dirt, clean when cold using a damp kitchen sponge and neutral detergent; then dry with a microfibre cloth.

Weekly cleaning

Clean and maintain the hob once a week using an ordinary glass ceramic cleaning product. Always follow the manufacturer's instructions. The silicon in these products creates a protective, water-repellent membrane which also resists dirt. All marks stay on the membrane and can therefore be removed easily. After cleaning, dry the surface with a clean cloth. Make sure that there is no detergent left on the cooking surface as it might undergo an aggressive reaction when heated up and could modify the structure of the cooking surface.

Food stains or residues

Light coloured marks from pans with aluminium bases can be easily cleaned off with a cloth moistened in vinegar. Remove any burnt-on residues after cooking; then rinse with water and dry thoroughly with a clean cloth. Dirt, which may have fallen on the hob while cleaning lettuce or potatoes, can scratch the hob when moving pans. Consequently, remove any dirt from the cooking surface immediately. Changes in colour do not affect the operation and stability of the glass. These are not alterations to

the material of the hob but just residues which have not been removed and have then carbonised. Shiny surfaces can form due to the bases of pans, especially aluminium ones, rubbing on the surface, and due to the use of unsuitable detergents. They are difficult to remove using conventional cleaning products. It may be necessary to repeat the cleaning process several times. Use of corrosive detergents or rubbing of pan bases can wear away the decoration on the hob over time and contribute to the formation of stains.



We recommend the use of cleaning products distributed by the manufacturer.



After cleaning, dry the appliance thoroughly to prevent any water or detergent from interfering with its operation or creating unsightly marks.

What to do if...

The hob does not work:

- Make sure that the hob is connected and that the main switch is turned on.
- Make sure that there is no power failure.
- Make sure that the fuse has not blown. In this case replace the fuse.
- Make sure that the circuit breaker of the residential electrical system has not tripped. In this case, reset the circuit breaker.

The cooking results are unsatisfactory:

- Make sure that the cooking temperature is not too high or too low.
- Make sure that the hob has proper ventilation and that the air intakes are completely free.

The hob smokes:

- Let the hob cool down and clean it once cooking is complete.
- Make sure that the food has not spilled out of the pan and use a larger cooking vessel, if needed.

The fuses blow or the circuit breaker of the residential electrical system trips repeatedly.

- Call Technical Support or an electrician. There are cracks or fissures in the hob:
- Turn off the appliance immediately,

disconnect the power supply and contact Technical Support.

INSTALLATION

Electrical connection



See General safety instructions.

General information

Check the mains characteristics against the data indicated on the plate.

The identification plate bearing the technical data, serial number and brand name is visibly positioned on the appliance.

Do not remove this plate for any reason.

The appliance must be connected to ground using a wire that is at least 20 mm longer than

The appliance can work in the following modes:

220-240 V 1N \sim

3 x 6 mm²

three-core cable

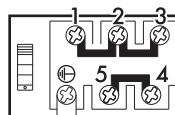
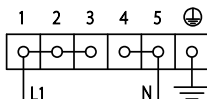

220-240 V 2 \sim

3 x 6 mm²

three-core cable

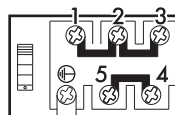
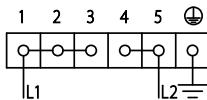

220-240 V 3 \sim

4 x 4 mm²

four-core cable

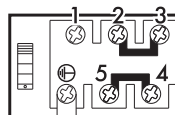
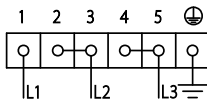

380-415 V 2N \sim

4 x 4 mm²

four-core cable

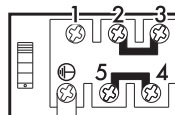
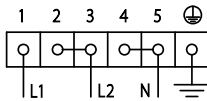

380-415 V 3N \sim

5 x 1.5 mm²

five-core cable

4-zone models only

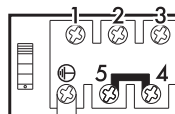
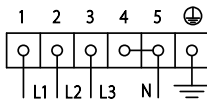

380-415 V 3N \sim

5 x 2.5 mm²

five-core cable

5-zone models only

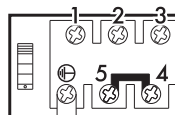
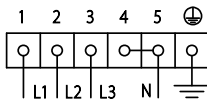

the other wires.

Terminal block connection

Arrange the cables in an orderly manner to avoid overlapping or contact with any jumpers. The cables must be of the correct length to avoid build-up/twisting inside the terminal box.

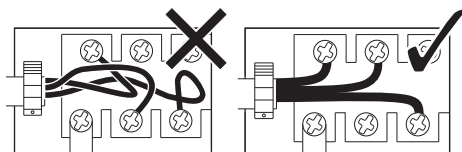



The values indicated refer to the cross-section of the internal lead.



The power cables are sized taking into account the coincidence factor (in compliance with standard EN 60335-2-6).



Always use the supplied jumper for each connection, if any. The connection between terminals 4 and 5 must always be made.

- To cancel the selection, press the ON/OFF key .



If the set limit is exceeded by increasing the power of a zone too much, the power level is shown alternately with the symbol , the zone level is automatically reset within the selected limits.

Table of power draws

Models	Power (kW)	
	maximum	minimum
60 cm	6.0	2.5
80 cm	7.4	2.5
90 cm with 4 zones	7.4	2.5
90 cm with 5 zones	9.1	2.5

Section cut from the countertop

Safety instructions for positioning and installation



See General safety instructions.

- Installation can be carried out on various materials such as masonry, metal, solid wood or plastic laminated wood as long as they are heat resistant (>90°C).
- Veneers, adhesives or plastic coatings on adjacent furniture should be temperature-resistant (>90°C), otherwise they might warp over time.
- If the piece of furniture does not have the required recess opening, either it will have to be cut or masonry work carried out by a competent technician.
- The minimum clearance between exhaust hoods and the cooking surface must be at least the distance indicated in the exhaust hood installation instructions.
- The minimum clearances must also be respected for the edges of the hob on the back as indicated in the assembly instructions.
- If the appliance is to be installed above an oven, the oven must be fitted with a cooling fan.

Fixed connection

Fit the power line with an all-pole circuit breaker with a contact separation distance sufficient to provide complete disconnection in category III overvoltage conditions, pursuant to installation regulations.

For the Australian/New Zealand market:



The circuit breaker incorporated in the fixed connection must comply with AS/NZS 3000.

Power limitation procedure





- This procedure is restricted to the installer.
- It can only be changed in the first minute after connection to the power supply.
- Depending on the model, the appliance is set at maximum power in factory.

To change the maximum power absorbed by the appliance (within one minute after connection to the power supply):

- Press and hold the  button.
- The current power is shown on the displays of the central zones; to change it, use the timer keys  and .



The Eco-Logic Advance function increases or decreases the power level in steps of 0.1 kW at each touch.

- To confirm the selection, press the timer keys  and  at the same time.

Appliance overall dimensions (mm)

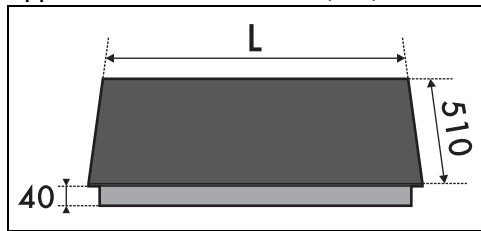

MODELS (cm)	L
60	600
80	770
90	900

with insulating silicone (B) and wipe off any excess. If for any reason the hob needs to be removed, cut the silicone using a cutter before attempting to remove it (C).

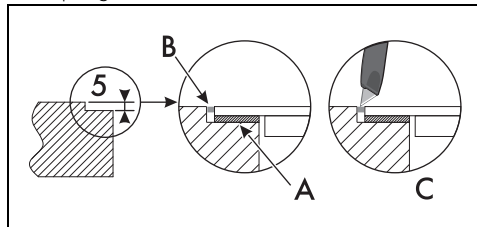

Built-in cabinet dimensions (mm)

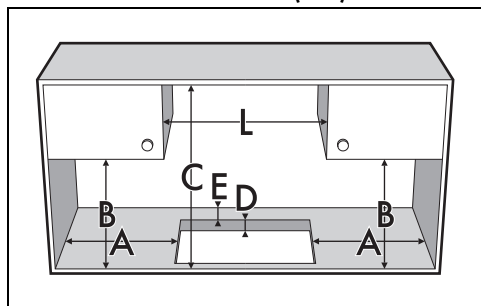

A	B	C	D	E
min. 90	min. 460	min. 750	20÷60	min. 50

Hob seal

To prevent leakage of liquid between the frame of the hob and the countertop, place the adhesive seal provided along the entire outer edge of the hob before assembly.

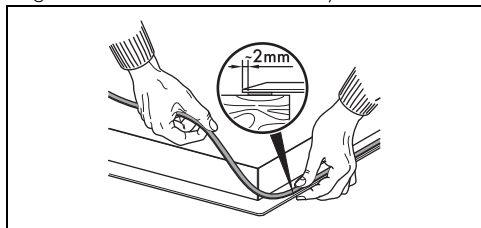

! Do not use silicone to secure the hob. This would make it impossible to remove the hob without damaging it.

In the case of flush mounting, after placing the adhesive seal (A) on the glass surface and after positioning and securing the hob, fill the edges

Standard and flush built-in model (mm)*

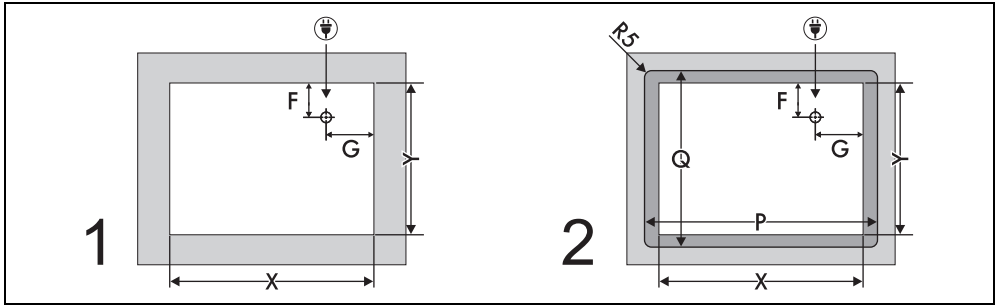

MODEL (cm)	X	Y	P	Q	F	G
60	565	490	604	514	30	265
80	745	490	774	514	230	350
90 (4 zones)	865	490	904	514	230	350
90 (5 zones)	865	490	904	514	22	560



Electrical connection

1. Standard built-in model

2. Flush built-in model

Mounting

On top of oven built-in unit

The clearance between the hob and the kitchen furniture or other installed appliances must be enough to ensure sufficient ventilation and air discharge. If installed above an oven, a space must be left between the bottom of the hob and the top of the appliance installed below.

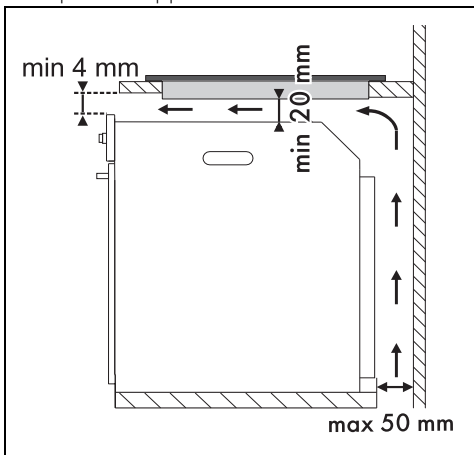

walls,

drawers, etc.), dishwashers or fridges under the hob, a double-layer wooden base must be installed at least 20 mm from the bottom of the hob to avoid any accidental contact. It must only be possible to remove the double-layer base using suitable equipment.

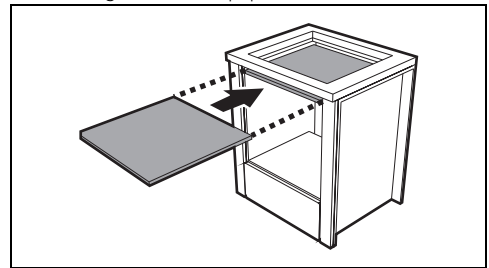

opens on bottom:

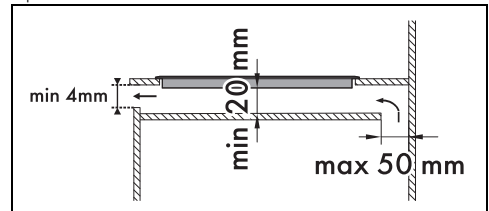

On top of empty kitchen unit or drawers

If there are other pieces of furniture (lateral

opens on rear:

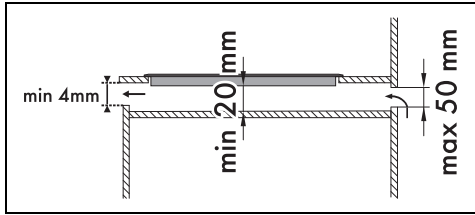

 Failure to install the double-layer wooden base exposes the user to possible accidental contact with sharp or hot parts.

 If installed on top of an oven, the latter must be equipped with a cooling fan.

Fixing to the built-in cabinet

 The clips should not be installed at the front of the appliance.

To ensure the hob is fixed and centred as accurately as possible, the clips provided must be positioned as described below:

1. Fit the clips by gently pressing them horizontally into the appropriate space.
2. Then turn them upwards to fix them in place.

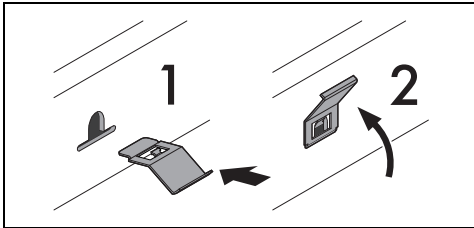

Fixing to the built-in cabinet

In order to ensure fixing to the built-in cabinet and optimum centring, the supplied fixing brackets must be screwed into the holes in the bottom casing.

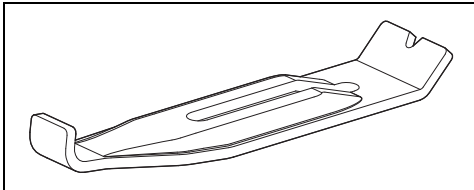

Screw the fixing brackets into the dedicated holes to properly fasten the hob to the built-in

structure.

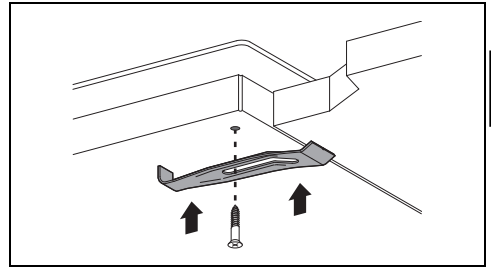

Instructions for the installer

- If you use a plug (if present) to connect to the power supply, the plug must be accessible after installation.
- Do not bend or trap the power cable.
- The appliance must be installed according to the installation diagrams.
- If the appliance does not work correctly after having carried out all the checks, contact your local Authorised Service Centre.
- Once the appliance has been installed, please explain to the user how to use it correctly.