

# Table of contents

|   |           |
|---|-----------|
| <b>1 Instructions</b>                       | <b>52</b> |
| 1.1 General safety instructions             | 52        |
| 1.2 Manufacturer's liability                | 57        |
| 1.3 Appliance purpose                       | 57        |
| 1.4 Identification plate                    | 57        |
| 1.5 This user manual                        | 57        |
| 1.6 Disposal                                | 57        |
| 1.7 How to read the user manual             | 58        |
| 1.8 To save energy                          | 59        |
| 1.9 Information for European Control Bodies | 59        |
| <b>2 Description</b>                        | <b>60</b> |
| 2.1 General Description                     | 60        |
| 2.2 Cooking hob                             | 61        |
| 2.3 Control panel                           | 62        |
| 2.4 Other parts                             | 62        |
| 2.5 Available accessories                   | 63        |
| <b>3 Use</b>                                | <b>64</b> |
| 3.1 Using the accessories                   | 65        |
| 3.2 Using the hob                           | 66        |
| 3.3 Using the storage compartment           | 72        |
| 3.4 Using the oven                          | 72        |
| 3.5 Cooking advice                          | 74        |
| 3.6 Programmer clock                        | 75        |
| <b>4 Cleaning and maintenance</b>           | <b>81</b> |
| 4.1 Cleaning the hob                        | 82        |
| 4.2 Cleaning the door                       | 83        |
| 4.3 Cleaning the oven cavity                | 85        |
| 4.4 Vapor Clean                             | 86        |
| 4.5 Extraordinary maintenance               | 88        |
| <b>5 Installation</b>                       | <b>90</b> |
| 5.1 Positioning                             | 90        |
| 5.2 Electrical connection                   | 95        |
| 5.3 Instructions for the installer          | 97        |

## TRANSLATION OF THE ORIGINAL INSTRUCTIONS

We advise you to read this manual carefully, as it contains all the instructions for maintaining the appliance's aesthetic and functional qualities.

For further information on the product: [www.smeg.com](http://www.smeg.com)



## 1 Instructions

### 1.1 General safety instructions

#### Risk of personal injury

- During use the appliance and its accessible parts become very hot. Never touch the heating elements during use.
- Protect your hands by wearing oven gloves when moving food inside the oven.
- Never try to put out a fire or flames with water: Turn off the appliance and smother the flames with a fire blanket or other appropriate cover.
- This appliance may be used by children aged at least 8 and by people of reduced physical, sensory or mental capacity, or lacking in experience in the use of electrical appliances, provided that they are supervised or instructed by adults who are responsible for their safety.
- Children must not play with the appliance.
- Keep children under the age of eight at a safe distance unless they are constantly supervised.
- Keep children under the age of 8 away from the appliance when it is in use.
- Cleaning and maintenance must not be carried out by unsupervised children.
- Be aware of how rapidly the cooking zones heat up. Do not place empty pans on the heat. Danger of overheating.
- Fats and oils can catch fire if they overheat. Do not leave the appliance unattended while preparing foods containing oils or fats. If fats or oils catch fire, never put water on them. Place the lid on the pan and turn off the relevant cooking zone.
- The cooking process must always be monitored. A short cooking process must be continuously monitored.
- Do not place metal objects, such as dishes or cutlery, on the hob surface during use as they may overheat.



- Do not insert pointed metal objects (cutlery or utensils) into the slots in the appliance.
- Do not pour water directly onto very hot trays.
- Keep the oven door closed during cooking.
- If you need to move food or at the end of cooking, open the door 5 cm for a few seconds, let the steam come out, then open it fully.
- Do not open the storage compartment (where present) when the oven is on and still hot.
- The items inside the storage compartment could be very hot after using the oven.
- **DO NOT USE OR STORE FLAMMABLE MATERIALS IN THE STORAGE COMPARTMENT (IF PRESENT) OR NEAR THE APPLIANCE.**
- **DO NOT USE AEROSOLS IN THE VICINITY OF THIS APPLIANCE WHILST IT IS IN USE.**
- Switch off the appliance immediately after use.
- **DO NOT MODIFY THIS APPLIANCE.**
- Always use any necessary/required personal protective equipment (PPE) before performing any work on the appliance (installation, maintenance, positioning or movement).
- Before performing any work on the appliance, switch off the power supply.
- Installation and servicing should be carried out by qualified personnel in accordance with current standards.
- Do not try to repair the appliance yourself or without the assistance of a qualified technician.
- If the power supply cable is damaged, contact technical support immediately and they will replace it.



## Instructions

### Risk of damaging the appliance

- Do not use abrasive or corrosive detergents (e.g. scouring powders, stain removers and metallic sponges) on glass parts.
- Use wooden or plastic utensils.
- Racks and trays should be inserted as far as they will go into the side guides. The mechanical safety locks that prevent them from being removed must face downwards and towards the back of the oven cavity.

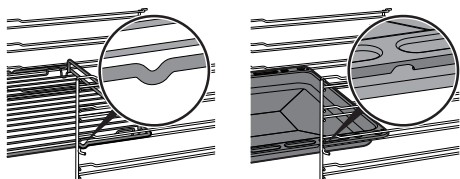

- Do not sit on the appliance.
- Do not use steam jets to clean the appliance.
- Do not obstruct ventilation openings and heat dispersal slots.
- Never leave the appliance unattended during cooking operations where fats or oils could be released, as these could then heat up and catch fire. Be very careful.
- Never leave objects on the cooking surface.

- DO NOT FOR ANY REASON USE THE APPLIANCE AS A SPACE HEATER.
- Do not spray any spray products near the oven.
- Do not use plastic cookware or containers when cooking food.
- Do not put sealed tins or containers in the oven.
- Remove all trays and racks which are not required during cooking.
- Do not cover the bottom of the oven cavity with aluminium or tin foil sheets.
- Do not place pans or trays directly on the bottom of the oven cavity.
- If you wish to use greaseproof paper, place it so that it will not interfere with the hot air circulation inside the oven.
- Do not use the open door to rest pans or trays on the internal glass pane.
- Cooking vessels or griddle plates should be placed inside the perimeter of the hob.
- All pans must have smooth, flat bottoms.



- If any liquid does boil over or spill, remove the excess from the hob.
- Take care not to spill acid substances such as lemon juice or vinegar on the hob.
- Do not put empty pans or frying pans on switched on cooking zones.
- If cracks or fissures form, or if the glass ceramic cooking surface breaks, turn off the appliance immediately. Disconnect the power supply and call Technical Support.
- People who have pacemakers or other similar devices fitted must make sure that the operation of these devices is not affected by the induction field, the frequency range of which is between 20 and 50 kHz.
- In conformity with the provisions regarding electromagnetic compatibility, the electromagnetic induction cooking hob comes under group 2 and class B (EN 55011).
- Do not use steam jets to clean the appliance.
- Do not use rough or abrasive materials or sharp metal scrapers.
- Do not use cleaning products containing chlorine, ammonia or bleach on parts made of steel or that have metallic surface finishes (e.g. anodizing, nickel- or chromium-plating).
- Do not use abrasive or corrosive detergents (e.g. scouring powders, stain removers and metallic sponges) on glass parts.
- Do not wash removable parts such as the hob pan support grids, flame-spreader crowns and burner caps in the dishwasher.
- Never use the oven door to lever the appliance into place when fitting.
- Avoid exerting too much pressure on the oven door when open.
- Do not use the handle to lift or move the appliance.



## Instructions

### Installation

- THIS APPLIANCE **MUST NOT BE INSTALLED** IN BOATS OR CARAVANS.
- The appliance must not be installed on a pedestal.
- Position the appliance into the cabinet cut-out with the help of a second person.
- To avoid potential overheating, the appliance must not be installed behind a decorative door or a panel.
- Have the electrical connection performed by authorised technical personnel.
- The appliance must be connected to earth in compliance with electrical system safety standards.
- Use cables withstanding a temperature of at least 90 °C.
- The tightening torque of the terminal board screws for the power supply wires must be 1.5 - 2 Nm.

### For this appliance

- After use, switch off the plates. Never rely solely on the cookware detector.
- Supervise children carefully as they cannot readily see the residual heat indication. After use the cooking zones remain hot for a certain period of time even if they have been turned off. Keep children away from the cooking zones.
- The glass ceramic surface is highly resistant to impact. However, prevent hard, solid objects from falling on the cooking surface as they may cause it to break if they are sharp.
- Do not use the glass ceramic cooking surface as a support surface.
- Ensure that the appliance is switched off before replacing the bulb.
- Do not rest any weight or sit on the open door of the appliance.
- Take care that no objects are stuck in the doors.



## 1.2 Manufacturer's liability

The manufacturer declines all liability for damage to persons or property caused by:

- Use of the appliance other than that specified
- Failure to comply with the instructions in the user manual
- Tampering with any part of the appliance
- The use of non-original spare parts.

## 1.3 Appliance purpose

- This appliance is intended for cooking food in the home environment. Every other use is considered improper.
- The appliance is not designed to operate with external timers or with remote-control systems.

## 1.4 Identification plate

The identification plate bears the technical data, serial number and brand name of the appliance. Do not remove the identification plate for any reason.

## 1.5 This user manual

This user manual is an integral part of the appliance and must therefore be kept in its entirety and within the user's reach for the whole working life of the appliance.

Read this user manual carefully before using the appliance.

## 1.6 Disposal



This appliance conforms to the WEEE European directive (2012/19/EU) and must be disposed of separately from other waste at the end of its service life. The appliance does not contain substances in quantities sufficient to be considered hazardous to health and the environment, in accordance with current European directives.

To dispose of the appliance:

- Cut the power supply cable and remove it.



**Power voltage**

**Danger of electrocution**

- Disconnect the mains power supply.
- Unplug the appliance.



## Instructions

- Deliver the appliance to the appropriate recycling centre for electrical and electronic equipment waste, or return it to the retailer when purchasing an equivalent product, on a one for one basis.

Our appliances are packaged in non-polluting and recyclable materials.

- Deliver the packing materials to the appropriate recycling centre.



### Plastic packaging Danger of suffocation

- Do not leave the packaging or any part of it unattended.
- Do not let children play with the plastic bags.

### 1.7 How to read the user manual

This user manual uses the following reading conventions:

#### Instructions



General information on this user manual, on safety and final disposal.

#### Description



Description of the appliance and its accessories.

#### Use



Information on the use of the appliance and its accessories, cooking advice.

#### Cleaning and maintenance



Information for proper cleaning and maintenance of the appliance.

#### Installation



Information for the qualified technician: Installation, operation and inspection.



Safety instructions



Information



Advice

1. Sequence of instructions for use.

- Standalone instruction.





## 1.8 To save energy

- Only preheat the appliance if the recipe requires you to do so.
- Unless otherwise indicated on the package, defrost frozen foods before placing them in the oven.
- When cooking several types of food it is recommended to cook the foods one after the other to make the best use of the already hot oven.
- Use dark metal moulds: They help to absorb the heat better.
- Remove all trays and racks which are not required during cooking.
- Stop cooking a few minutes before the time normally used. Cooking will continue for the remaining minutes with the heat which has accumulated inside the oven.
- Reduce any opening of the door to a minimum to avoid heat dispersal.
- Keep the inside of the oven clean at all times.

## 1.9 Information for European Control Bodies

### Fan forced mode

the ECO function used to define the energy efficiency class complies with the specifications of European standard EN 60350-1.

### Energy efficiency technical data

Information in accordance with the European energy labelling and ecodesign regulations is contained in a separate document accompanying the product instructions. These data are present in the "Product information sheet" that can be downloaded from the website at the page dedicated to the product in question.

### Light sources

- This appliance contains user-replaceable light sources.

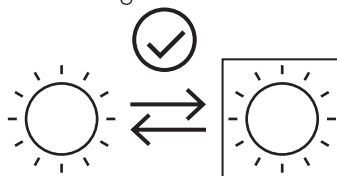

- The light sources contained in the appliance are declared suitable for operation at ambient temperature  $\geq 300^{\circ}\text{C}$  and intended for use in high temperature applications such as ovens.
- This appliance contains light sources of efficiency class "G".



# Description

## 2 Description

### 2.1 General Description

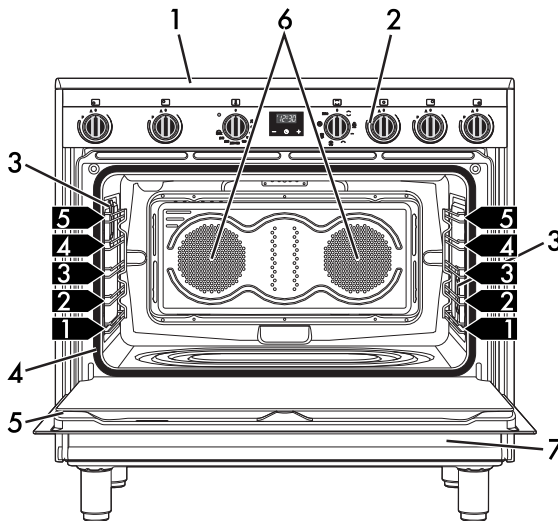
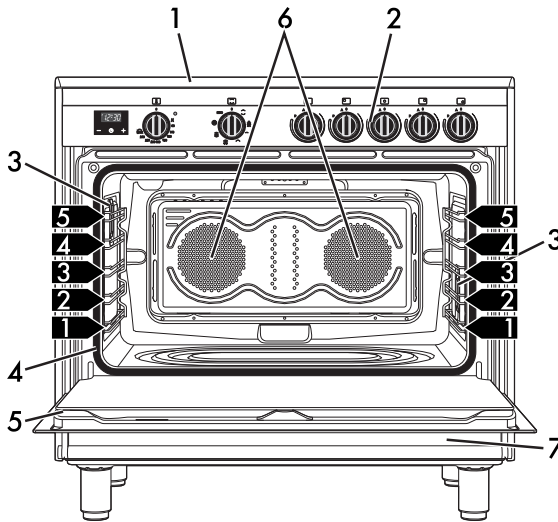

- 1 Cooking hob
- 2 Control panel
- 3 Light bulb
- 4 Seal

- 5 Door
- 6 Fan
- 7 Storage compartment

**1,2,3** ▶ Rack/tray support frames



## 2.2 Cooking hob

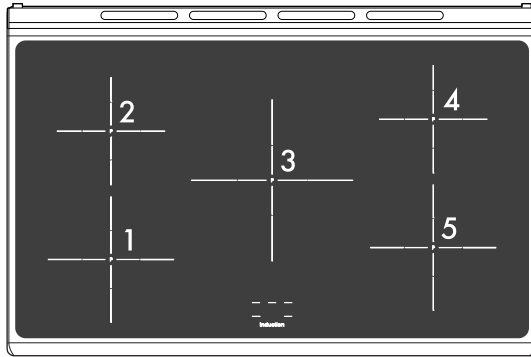

| Zone | Outside diameter (mm) | Max. power draw (W) * | Power draw in booster function (W) * |
|------|-----------------------|-----------------------|--------------------------------------|
| 1    | 210                   | 2300                  | 3000                                 |
| 2    | 180                   | 1300                  | 1400                                 |
| 3    | 270                   | 2300                  | 3000                                 |
| 4    | 180                   | 1300                  | 1400                                 |
| 5    | 210                   | 2300                  | 3000                                 |

\* Power levels are approximate and can vary according to the pan used or the settings made.

### Advantages of induction cooking



The hob is equipped with an induction generator for each cooking zone. Each generator located under the glass ceramic cooking surface creates an electromagnetic field which induces a thermal current in the base of the pan. This means the heat is no longer transmitted from the hob to the pan but created directly inside the pan by the inductive current.

- Energy saving thanks to the direct transmission of energy to the pan (suitable magnetisable cookware is required) compared to traditional electric cooking.
- Improved safety as the energy is only transmitted to the pan placed on the hob.
- High level of energy transmitted from the induction cooking zone to the base of the pan.
- Rapid heating speed.
- Reduced danger of burns as the cooking surface is only heated under the base of the pan; foods which overflow do not stick.



## Description

### 2.3 Control panel

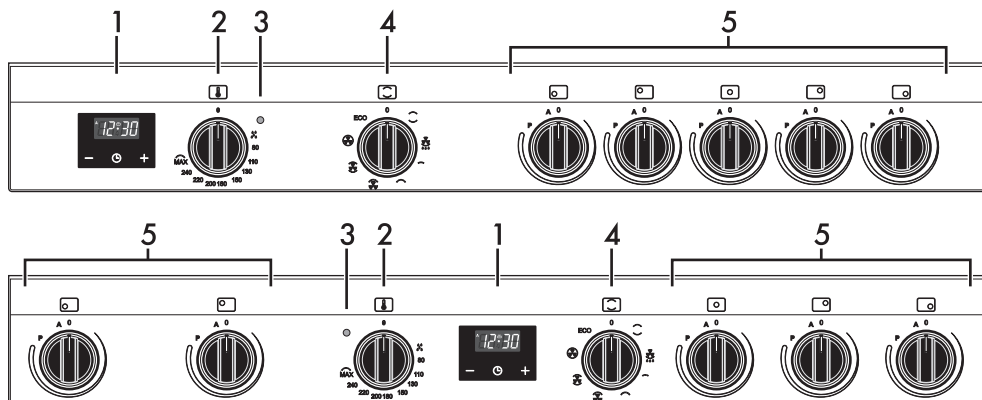

#### 1 Programmer clock

For displaying the current time, setting programmed cooking operations and the minute minder timer.

#### 2 Temperature knob

This knob allows you to select the cooking temperature. Turn the knob clockwise to the required value, between the minimum and maximum setting.

#### 3 Indicator light

The indicator light comes on to indicate that the oven is heating up. It turns off as soon as it reaches the set temperature. It flashes regularly to indicate that the temperature set inside the oven is kept constant.

#### 4 Function knob

The oven's various functions are suitable for different cooking methods. After selecting the required function, set the cooking temperature using the temperature knob.

#### 5 Hob cooking zone knobs

Useful for controlling the cooking zones of the induction hob. Turn the knobs clockwise to adjust the operating power of the hot plate from a minimum of **1** to a maximum of **9**. The working power is indicated on the display on the hob.

### 2.4 Other parts

#### Shelves

The appliance features shelves to position trays and racks at different heights. The insertion heights are indicated from the bottom upwards (see 2.1 General Description).

#### Interior lighting

The appliance's interior lighting comes on:

- When the door is opened.
- When any function is selected, apart from the **ECO** function.



## Cooling fan

The fan cools the ovens and comes into operation during cooking.

The fan causes a steady outflow of air that exits from the rear of the appliance and which may continue for a brief period of time even after the appliance has been turned off.

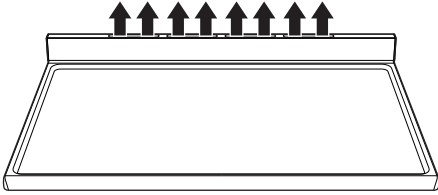

Do not obstruct ventilation openings and heat dispersal slots.

## 2.5 Available accessories

### Deep tray

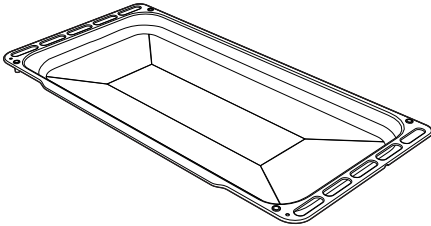

Useful for collecting fat from foods placed on the rack above and for cooking pies, pizzas and baked desserts.

### Rack

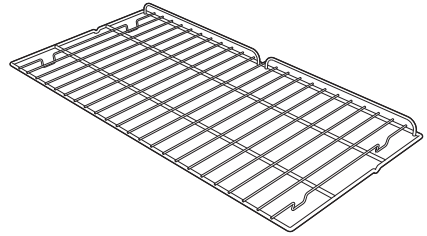

Used for supporting containers with food during cooking.

### Tray rack

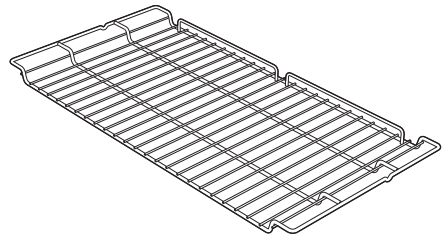

To be placed over the top of the tray; for cooking foods which may drip.



The accessories intended to come into contact with food are made of materials that comply with the provisions of current legislation.



Supplied and optional accessories can be requested to Authorised Service Centres. Use only original accessories supplied by the manufacturer.



## 3 Use

### Instructions



**High temperature inside the oven during use**

#### **Danger of burns**

- Keep the oven door closed during cooking.
- Protect your hands by wearing oven gloves when moving food inside the oven.
- Do not touch the heating elements inside the appliance.
- Do not pour water directly on very hot trays.
- Keep children under the age of 8 away from the appliance when it is in use.
- If you need to move food or at the end of cooking, open the door 5 cm for a few seconds, let the steam come out, then open it fully.
- Oils and fats could catch fire if overheated. Be very careful.



**High temperature inside the storage compartment**

#### **Danger of burns**

- Do not open the storage compartment when the oven is on and still hot.
- The items inside the storage compartment could be very hot after using the oven.



**Improper use**

#### **Risk of damage to surfaces**

- Do not cover the bottom of the oven cavity with aluminium or tin foil sheets.
- If you wish to use greaseproof paper, place it so that it will not interfere with the hot air circulation inside the oven cavity.
- Do not place pans or trays directly on the bottom of the oven cavity.
- Do not use the open door to place pans or trays on the internal glazing pane.
- Do not pour water directly on very hot trays.
- Cooking vessels or griddle plates should be placed inside the perimeter of the hob.
- All pans must have smooth, flat bottoms.
- If any liquid does boil over or spill, remove the excess from the hob.
- Never place pans with bases which are not perfectly flat and smooth.
- Avoid hard, solid objects falling on the surface of the hob.
- In case you notice cracks or fissures, turn off the appliance immediately, disconnect the power supply and contact Technical Support.
- Do not use the hob as a support surface.



High temperature inside the storage compartment during use  
**Danger of fire or explosion**

- Do not spray any spray product near the appliance.
- Do not use or leave flammable materials near the oven or the storage compartment.
- Do not use plastic cookware or containers for cooking.
- Do not place sealed tins or containers in the oven cavity.
- Do not leave the appliance unattended during cooking operations where fats or oils could be released.
- Remove all trays and racks which are not required during cooking.

### First use

1. Remove any protective film from the outside or inside of the appliance, including accessories.
2. Remove any labels (apart from the technical data plate) from the accessories and from the cooking compartments.
3. Remove and wash all the appliance's accessories (see 4 Cleaning and maintenance).

### Oven cavity

4. Heat the empty oven at the maximum temperature to burn off any residues left by the manufacturing process.

## 3.1 Using the accessories

### Racks and trays

Racks and trays have to be inserted into the side guides until they come to a complete stop. The mechanical safety locks that prevent the rack from being taken out accidentally have to face downwards and towards the oven back.

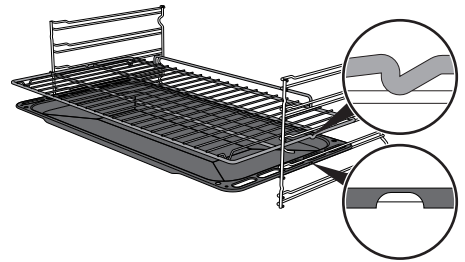

Gently insert racks and trays into the oven until they come to a stop.



Clean the trays before using them for the first time to remove any residues left by the manufacturing process.



## 3.2 Using the hob

**i** On first connection to the electrical mains, an automatic check will be carried out that will switch on all indicator lights for a few seconds.

**i** After use, turn off the hot plates used by returning the appropriate knob to the **O** position. Never rely solely on the cookware detector.

All the appliance's control and monitoring devices are located together on the front panel. The relevant cooking zone is indicated next to each knob.

Just turn the knob clockwise to the required power setting.

### Cookware suitable for use in induction cooking

Cookware used on the induction cooking surface must be made of metal, with magnetic properties and a sufficiently large base.

#### Suitable cookware:

- Enamelled steel cookware with thick bases.
- Cast iron cookware with an enamelled base.
- Cookware in multilayer stainless steel, ferritic stainless steel and aluminium with a special base.

#### Unsuitable cookware:

- Copper, stainless steel, aluminium, fireproof glass, wood, ceramic and terracotta cookware.

To see whether the pan is suitable, bring a magnet close to the bottom: if it is attracted, the pan is suitable for induction cooking. If you do not have a magnet, you can put a small amount of water in the pan, place it on a cooking zone and start the cooking zone. If the symbol  appears on the display, it means the pan is not suitable.

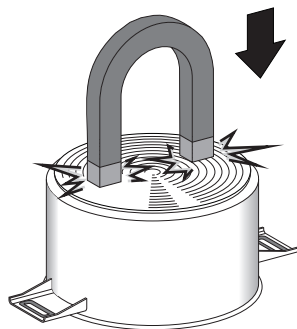

Use only cookware with a perfectly flat bottom which is suitable for induction hot plates. Using cookware with an irregular bottom could jeopardise the efficiency of the heating system and prevent cookware from being detected on the cooking zone.





## Cookware recognition

When there is no saucepan on a cooking zone or if the saucepan is too small, no energy will be transmitted and the symbol



will appear on the display.

If there is a suitable saucepan on the cooking zone, the recognition system notices it and turns on the hob to the power level set using the knob. Energy transmission is also interrupted when the saucepan is removed from the cooking zone (the symbol  will be shown on the display).

If the cookware recognition function is activated in spite of the saucepan or frying pan on the cooking zone being smaller than the zone itself, only the necessary energy will be transmitted.

**Cookware recognition limits:** The minimum diameter of the pan base is indicated by the square image on the cooking zone.

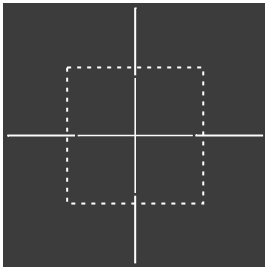

Pans with smaller diameters risk not being detected and therefore not activating the inductor.

## Limiting the cooking duration

The hob has an automatic device which limits the duration of use.

If the cooking zone settings are not changed, the maximum duration of operation for each zone depends on the power level selected.

When the device for limiting the duration of use is activated, the cooking zone turns off, a short alert sounds and, if the zone is hot, the  symbol appears on the display.

| Set power level | Maximum cooking duration in hours |
|-----------------|-----------------------------------|
| 1               | 8                                 |
| 2               | 6                                 |
| 3 - 4           | 5                                 |
| 5               | 4                                 |
| 6 - 7 - 8 - 9   | 1 ½                               |

## Protection from overheating

If the hob is used on full power for a long period, the electronics will have trouble cooling down if the room temperature is high.

To avoid excessively high temperatures forming in the electronics, the power to the cooking zone is reduced automatically.



# Use

## Advice on energy-saving

- The diameter of the base of the pan must correspond to the diameter of the cooking zone.



- When buying a pan, check whether the diameter indicated is that of the base or the top of the pan, as the top is almost always larger than the base.
- When preparing dishes with long cooking times, you can save time and energy by using a pressure cooker, which also makes it possible to preserve the vitamins in the food.
- Make sure that the pressure cooker contains enough liquid as, if there is not enough and it overheats, this may cause damage to both the pressure cooker and the cooking zone.
- If possible, always cover saucepans with a suitable lid.
- Choose a pan suitable for the quantity of food to be cooked. A large, half-empty saucepan leads to a waste of energy.



Under certain circumstances, if the hob and the oven are being used at the same time, the maximum power limit that can be used by the electrical system might be exceeded.

## Power levels

The power in the cooking zone can be adjusted to various levels. The table shows the levels suitable for various types of cooking.

| Power level | Suitable for:  |
|-------------|--|
| 0           | OFF setting  |
| 1 - 2       | Cooking small amounts of food (minimum power)              |
| 3 - 4       | Cooking  |
| 5 - 6       | Cooking large quantities of food, roasting larger portions |
| 7 - 8       | Roasting, slow frying with flour                           |
| 9           | Roasting   |
| p *         | Roasting / browning, cooking (maximum power)               |

\* see booster function

## Residual heat



**Improper use**  
**Danger of burns**

- Supervise children carefully as they cannot easily see the residual heat indicator. The cooking zones remain hot for a certain period of time even after they have been turned off. Make sure that children never touch the hob.

If the cooking zone is still hot after being switched off, the symbol **H** will be displayed on the display. The symbol clears once the temperature drops below 60 °C.



## Heating accelerator

**i** Each cooking zone is equipped with a heating accelerator that allows the maximum power to be delivered for a time that is proportional to the selected power.

This function allows the selected power to be achieved in the shortest amount of time.

1. Turn the knob anti-clockwise to position **A** and then release it. The display shows the symbol **A**.
2. Select the required heating power (**1 - 8**) within 3 seconds. The selected power and symbol **A** will flash alternately on the display.

The power level can be increased at any moment. The "maximum power" period will automatically be modified.

Once the acceleration period is over the power level will remain the same as the one previously selected.

 If the power is reduced, by turning the knob anti-clockwise, the heating accelerator will automatically be disabled.

## Booster function

**i** The booster function allows the cooking zone to be activated at maximum power for as long as 5 minutes. It can be used to bring a large quantity of water to a boil rapidly or to broil meat.

- Turn the knob clockwise to the **P** position for two seconds and then release.

The display shows the symbol **P**. After 5 minutes the **Booster** function will automatically be disabled and cooking will continue at power level **9**.

**Only for some zones:** the Booster function is always enabled and has to be disabled manually using the corresponding knob.

**i** The booster function has priority over the heating accelerator function.

## Power control

The hob is fitted with a power control module that optimises/limits consumption. If the overall set power level exceeds the maximum limit permitted, the electronic circuit board will automatically manage the power supplied by the hot plates.



## Use

The module tries to maintain the maximum deliverable power levels. Levels set by the automatic control will appear on the display. The flashing of a power level indicates that it will be automatically limited to a new level selected by the power control module.

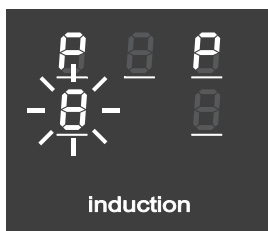

### Hob power limitation



The induction hob is configured to operate at **7.4 kW**, but it can be set to operate at **4.8 kW** or **3.7 kW**.

1. Disconnect the appliance from the mains power supply and wait 10 seconds before turning the power back on.



The power level of the hob must be set within 2 minutes of it being connected to the mains power supply.

2. Turn the front left and front right cooking zone knobs anticlockwise at the same time to position "A", and keep them in this position for 3 seconds.

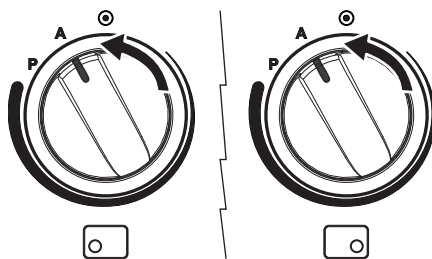

The rear left and rear right cooking zone displays will indicate "7." and "4".

3. Release the knobs.



Priority is given to the last zone set.



4. Turn and hold both knobs anti-clockwise again.

The rear left and rear right cooking zone displays will indicate the power levels "4." and "8".

5. Release the knobs.

6. Turn and hold both knobs anti-clockwise again.

The rear left and rear right cooking zone displays will indicate the power levels "3." and "7".

7. Release the knobs.



After having released the knobs at the required power level, wait until the displays turn off.



The power level can be changed again up to 4 minutes after the displays have turned off (without having to disconnect the appliance from the power supply).



The last power setting will remain selected even in the event of a power failure.



When power limitation is active, not all the power levels of the zones are selectable; in some cases some zones cannot be activated or the system automatically reduces the power levels of the active zones. This is not a malfunction but a consequence of the power limitation

## Possible cooking zone combinations

| Zone 1 | Zone 2 | Zone 3 | Zone 4 | Zone 5 |
|--------|--------|--------|--------|--------|
| 9      | 9      | 9      | P      | -      |
| 9      | 9      | 9      | -      | 7      |
| 9      | 9      | 8      | 8      | 7      |
| 9      | 9      | P      | 7      | -      |
| 9      | 9      | 7      | 9      | 7      |
| 9      | 9      | 9      | P      | -      |
| 9      | 9      | -      | P      | 9      |
| 9      | 9      | 7      | -      | 9      |
| 9      | 9      | 7      | 8      | 8      |
| 9      | 9      | 8      | 7      | 8      |
| 9      | 9      | -      | 7      | P      |

## Control lock



The controls lock is a device that protects the appliance from accidental or inappropriate use.

1. With all cooking zones off, simultaneously turn counterclockwise the two knobs - among those for cooking control - for the front and rear left cooking zones (position **A**).
2. Keep them turned until the symbols  appear on the display.
3. Release the knobs.

In order to remove the control lock repeat the same operations described previously.



If the knobs have been kept turned to the **A** position for more than 30 seconds a fault message is displayed 



## Use



After a prolonged period of interruption to the power supply, the control lock will be deactivated. If this is the case, turn it back on as described above.

### Error codes

If the display shows one of the following error codes **E1**, **E2**, contact Technical Assistance.

### 3.3 Using the storage compartment

The storage compartment is at the bottom of the cooker. To open it, pull the handle towards you. It can be used to store cookware or metallic objects necessary when using the appliance.

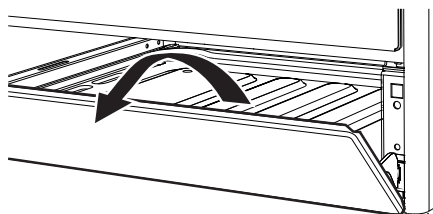

### 3.4 Using the oven

#### Switching on the oven



To switch on the oven:

1. Select the cooking function using the function knob.

2. Select the temperature using the temperature knob.



Ensure that the programmer clock shows the cooking duration symbol , otherwise it will not be possible to turn on the oven.

Press the keys  and  at the same time to reset the programmer clock.

### Functions list



#### Static

As the heat comes from above and below at the same time, this system is particularly suitable for certain types of food. Traditional cooking, also known as static cooking, is suitable for cooking just one dish at a time. Perfect for all types of roasts, bread and cakes, and in any case, particularly suitable for fatty meats such as goose and duck.



#### Fan + lower element

The combination of the fan with just the lower heating element allows cooking to be completed more rapidly. This system is recommended for sterilising or for finishing off the cooking of foods which are already well-cooked on the surface, but not inside, which therefore need a little more heat. Perfect for any type of food.

In pyrolytic models, the special defrost and proving functions are brought together under the same function.



### Small grill

Using only the heat released from the central element, this function allows you to grill small portions of meat and fish for making kebabs, toasted sandwiches and any types of grilled vegetable side dishes.



### Grill

The heat coming from the grill element gives perfect grilling results above all for thin and medium thickness meat and, in combination with the rotisserie (where fitted), gives the food an even browning at the end of cooking. Perfect for sausages, spare ribs and bacon. This function enables large quantities of food, particularly meat, to be grilled evenly.



### Fan with grill

The air produced by the fan softens the strong heatwave generated by the grill, grilling perfectly even very thick foods. Perfect for large cuts of meat (e.g. shin of pork).



### Fan assisted

The operation of the fan, combined with traditional cooking, ensures consistent cooking even with complex recipes. Perfect for biscuits and cakes, even when simultaneously cooked on several levels. (For multiple-level cooking, we recommend using the 2nd and 4th shelf).



### Fan with round heating element

The combination of the fan and the round heating element (incorporated in the rear of the oven) allows you to cook different foods on several levels, as long as they need the same temperatures and same type of cooking. Hot air circulation ensures instant and even distribution of heat. It will be possible, for instance, to cook fish, vegetables and biscuits simultaneously (on different levels) without odours and flavours mingling.



### Eco

This function is particularly suitable for cooking on a single shelf with low energy consumption.

It is recommended for all types of food, excluding those that can create a lot of humidity (such as vegetables).

To obtain maximum energy savings and reduce cooking times, it is recommended to place food in the oven without preheating.



When using the ECO function, avoid opening the door during cooking.



Cooking (and preheating) times are longer with the ECO function.



The ECO function is a delicate cooking function and is recommended for food withstanding temperatures lower than 210 °C; in case of cooking at higher temperatures, select another function.



### Vapour Clean

This function makes cleaning easier using the steam produced by a small quantity of water poured onto the appropriate groove placed on the bottom.



## 3.5 Cooking advice

### General advice

- Use a fan assisted function to achieve consistent cooking at several levels.
- It is not possible to shorten cooking times by increasing the temperature (the food could be overcooked on the outside and undercooked on the inside).

### Advice for cooking meat

- Cooking times vary according to the thickness and quality of the food and to consumer taste.
- Use a meat thermometer when roasting meat, or simply press on the roast with a spoon. If it is hard, it is ready; If not, it needs another few minutes cooking.

### Advice for cooking with the Grill and the Fan grill

- Meat can be grilled even when it is put into the cold oven or into the preheated oven if you wish to change the effect of the cooking.

- With the Fan grill function, we recommend that you preheat the oven before grilling.
- We recommend placing the food at the centre of the rack.
- With the Grill function, we recommend that you turn the temperature knob to the maximum value near the symbol  to optimise cooking.
- Foods should be seasoned before cooking. Foods should also be coated with oil or melted butter before cooking.
- Use the oven tray on the first bottom shelf to collect liquids produced by grilling.

### Advice for cooking desserts/pastries and biscuits

- Use dark metal moulds: They help to absorb the heat better.
- The temperature and the cooking time depend on the quality and consistency of the dough.
- To check whether the dessert is cooked right through: At the end of the cooking time, put a toothpick into the highest point of the dessert. If the dough does not stick to the toothpick, the dessert is cooked.
- If the dessert collapses when it comes out of the oven, on the next occasion reduce the set temperature by about 10 °C, selecting a longer cooking time if necessary.
- While cooking desserts or vegetables, excessive condensation may form on the glass. In order to avoid this, open the door very carefully a couple of times while cooking.





### Advice for defrosting and proving

- Place frozen foods without their packaging in a lidless container on the first shelf of the oven.
- Avoid overlapping the food.
- To defrost meat, use the rack placed on the second level and a tray on the first level. In this way, the liquid from the defrosting food drains away from the food.
- The most delicate parts can be covered with aluminium foil.
- For successful proving, a container of water should be placed in the bottom of the oven.

### To save energy

- Stop cooking a few minutes before the time normally used. Cooking will continue for the remaining minutes with the heat which has accumulated inside the oven.
- Reduce any opening of the door to a minimum to avoid heat dispersal.
- Keep the inside of the appliance clean at all times.



### 3.6 Programmer clock



 Decrease key

 Clock key



 Increase key

 Ensure that the programmer clock shows the cooking duration symbol , otherwise it will not be possible to turn on the oven. Press the key  to reset the programmer clock.

### Setting the time

 If the time is not set, the oven will not switch on.

On the first use, or after a power failure, the digits  will be flashing on the appliance's display.

1. Hold down the clock key  for two seconds. The dot between the hours and the minutes flashes.
2. The time can be set via the value increase key  and value decrease key . Keep the key pressed in to increase or decrease rapidly.





## Use

3. Wait 7 seconds. The dot between the hours and the minutes stops flashing.
4. The symbol  on the display indicates that the appliance is ready to start cooking.

At the end of cooking the heating elements will be deactivated. On the display, the symbol  turns off, the symbol **A** flashes and the buzzer sounds.

6. To turn the buzzer off, simply press one of the programmer clock keys.
7. Press the clock key  to reset the programmer clock.



To change the time, hold down the value increase key  and value decrease key  at the same time for two seconds, then set the time.









It is not possible to set a cooking time of more than 10 hours.



### Timed cooking



Timed cooking is the function which allows a cooking operation to be started and then ended after a specific length of time set by the user.

1. Keep the clock key  pressed until the symbol  appears.
2. Press the clock key  again. On the display the symbol **A** and the text  appear, alternating with the current time.
3. Use the value increase  and value decrease  keys to set the required minutes of cooking.
4. Select a function and a cooking temperature.
5. Wait approx. 5 seconds without pressing any key in order for the function to activate. The current time and the symbols  and **A** will appear on the display.







To cancel the set programming press and hold down the value increase  and the value decrease  keys at the same time and then turn the oven off manually.



### Programmed cooking



Programmed cooking is the function which allows a cooking operation to be started at a set time and then ended after a specific length of time set by the user.



1. Set the cooking time as described in the previous point Timed cooking.
2. Hold the menu key  down for 2 seconds.
3. Press the menu key  again. The display will show the digits  and the text  in sequence,



- while the **A** symbol flashes (for example, the current time is 17:30)
- Use the **—** or **+** key to set the required minutes. (for example 1 hour)
  - Press the menu key . The text  will appear on the display in sequence with the pre-set cooking duration added to the current time (for example, the cooking end time shown is 18:30).
  - Press the **—** or **+** key to set the cooking end time. (for example, 19:30).



Bear in mind that a few minutes for oven preheating must be added to the cooking time.

- Wait approx. 7 seconds without pressing any key in order for the function to activate. The current time will appear on the display, and the symbols **A** and  will turn off while the  indicator light comes on.
- Select a cooking temperature and function.
- At the end of cooking the heating elements will be deactivated. On the display, the symbol  turns off, the symbol **A** flashes and the buzzer sounds.

- Return the function and temperature knobs to **0**.
- To turn off the buzzer just press any key of the programmer clock.
- Press the **—** and **+** keys at the same time to reset the set program.





It is not possible to set a cooking time of more than 10 hours.



It is not possible to set a programmed cooking time of more than 24 hours.





After setting, hold the menu key  down for 2 seconds to display the cooking time remaining. Press the menu key  again. The display shows the text  and the remaining cooking time in sequence.

### Minute minder timer



The minute minder timer does not stop the cooking operation but rather informs the user when the set time has run out.

The minute minder timer can be activated at any time.

- Keep the clock key  pressed for per a few seconds. The display shows the figures  and the symbol  flashing between the hours and minutes.



## Use

- Use the value increase and value decrease keys to set the number of minutes required.
- Wait approx. 5 seconds without pressing any key to finish setting the minute minder. The current time and the symbols and appear on the display.

A buzzer will sound when the set time is reached.

- Press the value decrease key to turn the buzzer off.

### Modifying the set data

- Press the clock key .
- Use the value increase and value decrease keys to set the number of minutes required.

### Deleting the set data

- Press the clock key .
- Hold down the value increase and value decrease keys at the same time.
- Then switch off the oven manually if cooking is in progress.

### Selecting the buzzer

The buzzer can have 3 tones.

- Hold down the value increase and value decrease keys at the same time.
- Press the clock key .
- Press the value decrease key to select a different buzzer tone.

**i** The minute minder timer can be set from 1 minute to a maximum of 23 hours and 59 minutes.



## Cooking information table

| Food            | Weight (kg) | Function           | Runner position from the bottom | Temperature (°C) | Time (minutes)                |                               |
|-----------------|-------------|--------------------|---------------------------------|------------------|-------------------------------|-------------------------------|
| Lasagne         | 3 - 4       | Static             | 1                               | 220 - 230        | 45 - 50                       |                               |
| Pasta bake      | 3 - 4       | Static             | 1                               | 220 - 230        | 45 - 50                       |                               |
| Roasted veal    | 2           | Turbo/Fan assisted | 2                               | 180 - 190        | 90 - 100                      |                               |
| Pork loin       | 2           | Turbo/Fan assisted | 2                               | 180 - 190        | 70 - 80                       |                               |
| Sausages        | 1.5         | Fan with grill     | 4                               | MAX              | 15                            |                               |
| Roast beef      | 1           | Turbo/Fan assisted | 2                               | 200              | 40 - 45                       |                               |
| Roast rabbit    | 1.5         | Round              | 2                               | 180 - 190        | 70 - 80                       |                               |
| Turkey breast   | 3           | Turbo/Fan assisted | 2                               | 180 - 190        | 110 - 120                     |                               |
| Roast pork neck | 2 - 3       | Turbo/Fan assisted | 2                               | 180 - 190        | 170 - 180                     |                               |
| Roast chicken   | 1.2         | Turbo/Fan assisted | 2                               | 180 - 190        | 65 - 70                       |                               |
|                 |             |                    |                                 |                  | <b>1<sup>st</sup> surface</b> | <b>2<sup>nd</sup> surface</b> |
| Pork chops      | 1.5         | Fan with grill     | 4                               | MAX              | 15                            | 5                             |
| Spare ribs      | 1.5         | Fan with grill     | 4                               | MAX              | 10                            | 10                            |
| Bacon           | 0.7         | Grill              | 5                               | MAX              | 7                             | 8                             |
| Pork fillet     | 1.5         | Fan with grill     | 4                               | MAX              | 10                            | 5                             |
| Beef fillet     | 1           | Grill              | 5                               | MAX              | 10                            | 7                             |
| Salmon trout    | 1.2         | Turbo/Fan assisted | 2                               | 150 - 160        | 35 - 40                       |                               |
| Delicate fish   | 1.5         | Turbo/Fan assisted | 2                               | 160              | 60 - 65                       |                               |
| Flounder        | 1.5         | Turbo/Fan assisted | 2                               | 160              | 45 - 50                       |                               |
| Pizza           | 1           | Turbo/Fan assisted | 2                               | MAX              | 8 - 9                         |                               |
| Bread           | 1           | Round              | 2                               | 190 - 200        | 25 - 30                       |                               |
| Focaccia        | 1           | Turbo/Fan assisted | 2                               | 180 - 190        | 20 - 25                       |                               |
| Ring cake       | 1           | Round              | 2                               | 160              | 55 - 60                       |                               |
| Jam tart        | 1           | Round              | 2                               | 160              | 35 - 40                       |                               |
| Ricotta cake    | 1           | Round              | 2                               | 160 - 170        | 55 - 60                       |                               |
| Jam tarts       | 1           | Turbo/Round        | 2                               | 160              | 20 - 25                       |                               |
| Chiffon cake    | 1.2         | Round              | 2                               | 160              | 55 - 60                       |                               |
| Profiteroles    | 1.2         | Turbo/Round        | 2                               | 180              | 80 - 90                       |                               |
| Sponge cake     | 1           | Round              | 2                               | 150 - 160        | 55 - 60                       |                               |
| Rice pudding    | 1           | Turbo/Round        | 2                               | 160              | 55 - 60                       |                               |
| Brioches        | 0.6         | Round              | 2                               | 160              | 30 - 35                       |                               |

The times indicated in the table do not include preheating times and are provided only as a guide.



# Cleaning and maintenance

## 4 Cleaning and maintenance

### Instructions



**Improper use**

**Risk of damage to surfaces**

- Do not use steam jets to clean the appliance.
- Do not use cleaning products containing chlorine, ammonia or bleach on parts made of steel or that have metallic surface finishes (e.g. anodizing, nickel- or chromium-plating).
- Do not use abrasive or corrosive detergents (e.g. scouring powders, stain removers and metallic sponges) on glass parts.
- Do not use rough or abrasive materials or sharp metal scrapers.
- Do not wash the removable components such as the hob grids, flame-spreader crowns and burner caps in a dishwasher.
- Do not spill sugar or sweet mixtures on the hob while cooking or place materials or substances which could melt on it (plastic or tin foil).



We recommend the use of cleaning products distributed by the manufacturer.

### Cleaning the surfaces

To keep the surfaces in good condition, they should be cleaned regularly after use. Let them cool first.

### Ordinary daily cleaning

Always use specific products only that do not contain abrasives or chlorine-based acids.

Pour the product onto a damp cloth and wipe the surface, rinse thoroughly and dry with a soft cloth or a microfibre cloth.

### Food stains or residues

Do not use steel sponges and sharp scrapers as they will damage the surface.

Use normal, non-abrasive products and a wooden or plastic tool, if necessary. Rinse thoroughly and dry with a soft cloth or a microfibre cloth.

Do not allow residues of sugary foods (such as jam) to set inside the oven. If left to set for too long, they might damage the enamel lining of the oven.



After cleaning, dry the appliance thoroughly to prevent water or detergent drips from interfering with its operation or creating unsightly marks.



## 4.1 Cleaning the hob

### Cleaning the glass ceramic hob

Light coloured marks from pans with aluminium bases can be easily cleaned off with a cloth moistened in vinegar. After cooking, remove any burnt residues; rinse with water and dry thoroughly with a clean cloth.

**Dirt** which may have fallen on the hob while cleaning lettuce or potatoes can scratch the hob when moving pans.

Consequently, remove any dirt from the cooking surface immediately.

**Changes in colour** do not affect the operation and stability of the glass. These are not alterations to the material of the hob but just residues which have not been removed and have then carbonised.

**Shiny surfaces** can form due to the bases of pans, especially aluminium ones, rubbing on the surface, and due to the use of unsuitable detergents. They are difficult to remove using conventional cleaning products. It may be necessary to repeat the cleaning process several times. Use of corrosive detergents or rubbing of pan bases can wear away the decoration on the hob over time and contribute to the formation of stains.

### Weekly cleaning

Clean and maintain the hob once a week using an ordinary glass ceramic cleaning product. Always follow the manufacturer's instructions. The silicon in these products creates a protective, water-repellent membrane which also resists dirt. All marks stay on the membrane and can therefore be removed easily. After cleaning, dry the surface with a clean cloth. Make sure that there is no detergent left on the cooking surface as it might undergo an aggressive reaction when heated up and could modify the structure of the cooking surface.

### Knobs



Do not use aggressive products containing alcohol or products for cleaning steel and glass when cleaning the knobs, as these products could cause permanent damage.

The knobs should be cleaned with a soft cloth dampened with warm water, then dried carefully. They can be removed by pulling them out of their housing.



## Cleaning and maintenance

### 4.2 Cleaning the door

#### Removing the door

For easier cleaning, the door can be removed and placed on a towel.

To remove the door proceed as follows:

1. Open the door completely and insert two pins into the holes on the hinges indicated in the figure.

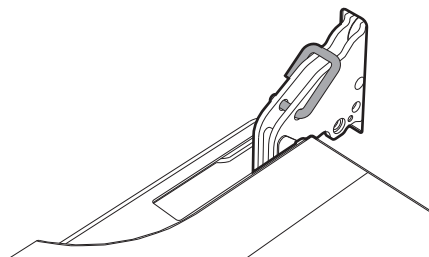

2. Grasp the door on both sides with both hands, lift it forming an angle of around 30° and remove it.

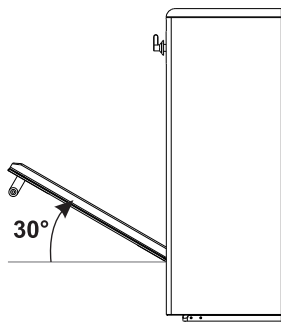

3. To reassemble the door, put the hinges in the relevant slots in the oven, making sure that grooved sections **A** are resting completely in the slots. Lower the door and once it is in position, remove the pins from the holes in the hinges.

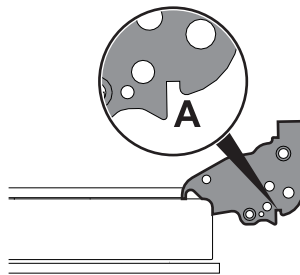

#### Cleaning the door glazing

The door glazing should always be kept thoroughly clean. Use absorbent kitchen roll. In case of stubborn dirt, wash with a damp sponge and an ordinary detergent.





## Removing the internal glass panes

For easier cleaning, the internal glass panes of the door can be removed.

1. Open the door.
2. Position the locking hooks in the hinge holes to prevent accidental closing of the door.
3. Remove the internal glazing pane by pulling the rear part gently upwards, following the movement indicated by the arrows (1).

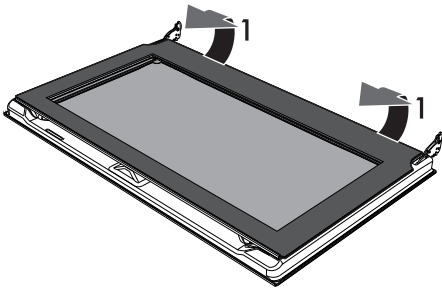

4. Pull the internal glazing pane from the front strip (2) to remove it from the door.

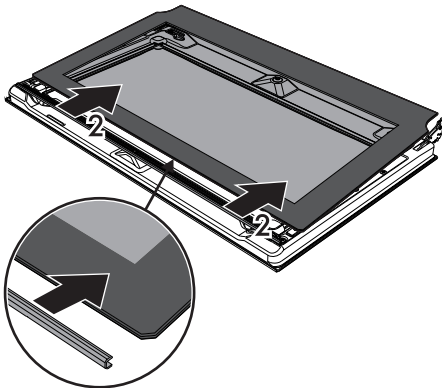

5. Remove the intermediate glass pane by lifting it upwards.

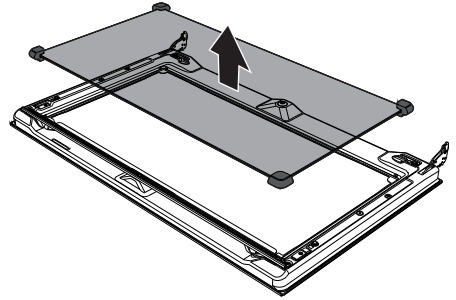

6. Clean the external glass pane and the previously removed panes. Use absorbent kitchen roll. In case of stubborn dirt, wash with a damp sponge and neutral detergent.

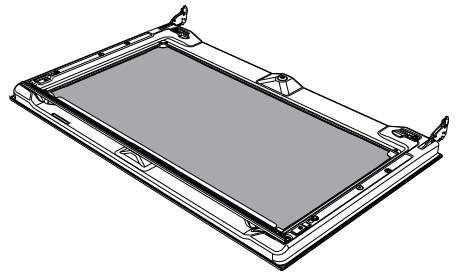

7. When you have finished cleaning, reinsert the intermediate glazing pane in its housing in the door.
8. To reposition the internal glazing pane, slide the upper part into the door strip and insert the two rear pins into their seats by pressing lightly.



## Cleaning and maintenance

### 4.3 Cleaning the oven cavity

For the best oven cavity upkeep, clean it regularly after having allowed it to cool. Avoid letting food residue dry inside the oven cavity, as this could damage the enamel.

Before cleaning, take away all removable items.

For easier cleaning, it is recommended to remove:

- the door
- the rack/tray support frames
- The seal.



In the event you are using specific cleaning products, we recommend running the oven at maximum temperature for 15-20 minutes in order to eliminate any residue.

### Removing racks/trays support frames

Removing the rack/tray support frames enables the sides to be cleaned more easily.

To remove the rack/tray support frames:

- Pull the frame towards the inside of the oven to unhook it from its groove **A**, then slide it out of the seats **B** at the back.

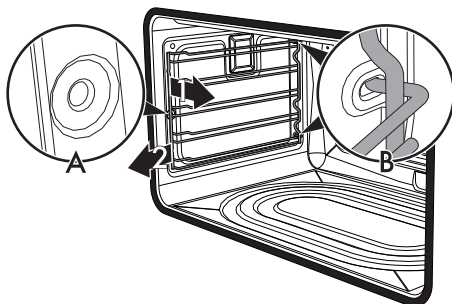

- When cleaning is complete, repeat the above procedures to put the rack/tray support frames back in.



## 4.4 Vapor Clean



Vapor Clean is an assisted cleaning procedure which facilitates the removal of dirt. Thanks to this process, it is possible to clean the inside of the oven very easily. The dirt residues are softened by the heat and water vapour for easier removal afterwards.



**Improper use**  
**Risk of damage to surfaces**

- Remove any food residues or large spills from previous cooking operations from the inside of the oven.
- Carry out assisted oven cleaning operations only when the oven is cold.

### Preliminary operations

Before starting the Vapor Clean cycle:

- Remove all accessories from inside the oven cavity.

- Pour approximately 40 cc of water into the tray. Make sure it does not overflow out of the cavity.

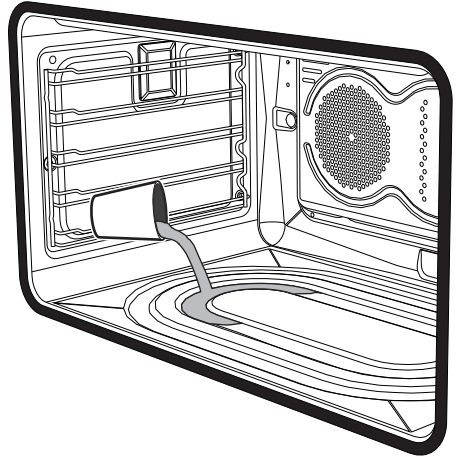

- Spray a water and washing up liquid solution inside the oven using a spray nozzle. Direct the spray against the side walls, upwards, downwards and towards the deflector.

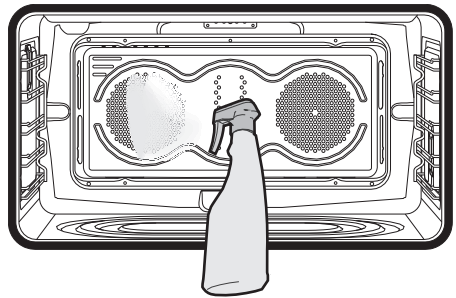

- Close the door.





We recommend spraying approx. 20 times at the most.



## Cleaning and maintenance

### Vapor Clean cycle setting

1. Turn the function knob to the symbol  and the temperature knob to the symbol .
  2. Set a cooking time of 18 minutes using the programmer clock.
- The Vapor Clean cycle starts a few seconds after the last press on the programmer clock keys.
3. At the end of the Vapor Clean cycle, the timer will deactivate the oven heating elements, the buzzer will start to sound and the numbers on the programmer clock dial will flash.

### End of the Vapor Clean cycle

4. Open the door and wipe away the less stubborn dirt with a microfibre cloth.
5. Use a non-scratch sponge with brass filaments on hard to remove deposits.
6. In case of grease residues use specific oven cleaning products.
7. Remove the water left inside the oven.

For improved hygiene and to avoid food being affected by any unpleasant odours, we recommend that the oven is dried using a fan assisted function at 160 °C for approximately 10 minutes.



We recommend wearing rubber gloves for these operations.



For easier manual cleaning of parts that are difficult to reach, we recommend removing the door.



## 4.5 Extraordinary maintenance

### Replacing the internal light bulb



Live parts  
**Danger of electrocution**

- Unplug the appliance from the mains.



The oven is fitted with a 40W light bulb.

1. Completely remove all accessories from inside the oven.
2. Remove the rack/tray support frames.
3. Remove the bulb cover using a tool (e.g. a screwdriver).



Take care not to scratch the enamel of the oven cavity wall.

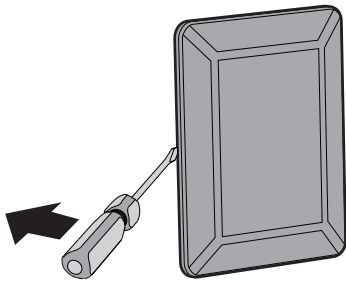

4. Slide out and remove the light bulb.

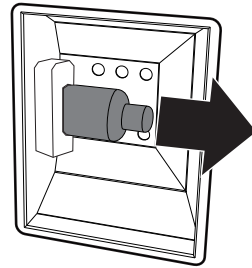

Do not touch the halogen light bulb directly with your fingers, use an insulating material.

5. Fit the new light bulb.
6. Refit the cover. Ensure the moulded part of the glass (A) is facing the door.

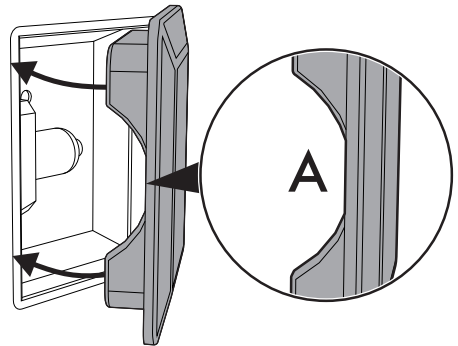

7. Press the cover down as far as it will go so that it attaches completely to the bulb support.



# Cleaning and maintenance

## Installing and removing the seal

To remove the seal:

- Unhook the clips located in the 4 corners and in the centre, then pull the seal outwards.

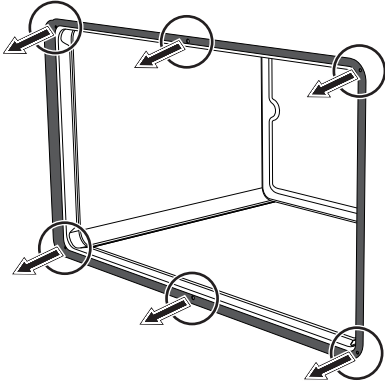

To refit the seal:

- Hook the clips located in the 4 corners and in the centre onto the seal.

## Seal maintenance tips

The seal should be soft and elastic.

- To keep the seal clean, use a non-abrasive sponge and wash with lukewarm water.



## 5 Installation

### 5.1 Positioning



**Heavy appliance**  
**Crushing hazard**

- Position the appliance into the cabinet cut-out with the help of a second person.



**Pressure on the open door**  
**Risk of damage to the appliance**

- Never use the oven door to lever the appliance into place when fitting.
- Avoid exerting too much pressure on the door when open.



**Heat production during appliance operation**  
**Risk of fire**

- Veneers, adhesives or plastic coatings on adjacent furniture should be temperature-resistant (not less than 90 °C).

Any wall units positioned above the worktop of the appliance must be at a minimum distance of at least Y mm. If a hood is installed above the hob, refer to the hood instruction manual to ensure the correct clearance is left.

|          |        |
|----------|--------|
| <b>X</b> | 150 mm |
| <b>Y</b> | 750 mm |

Depending on the type of installation, this appliance belongs to classes:

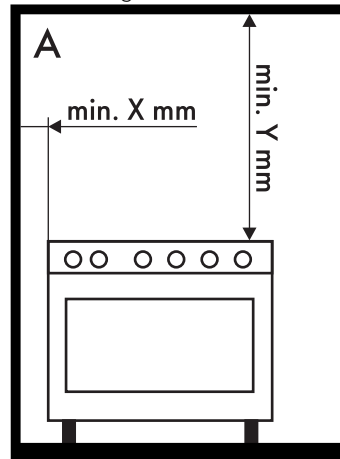

**A - Class 1**

**(Free-standing appliance)**

This appliance may be installed next to walls, one of which must be higher than the worktop, at a minimum distance of **X** mm from the side of the appliance, as shown in figures "A" and "C" relative to the installation classes.



# Installation

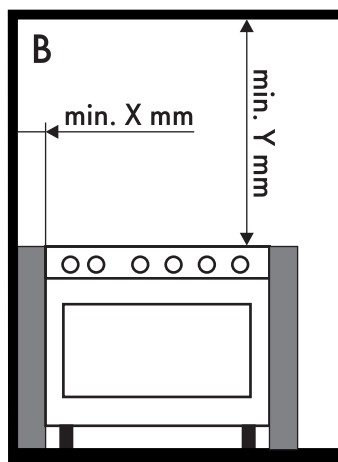

**B - Class 2 subclass 1**  
(Built-in appliance)

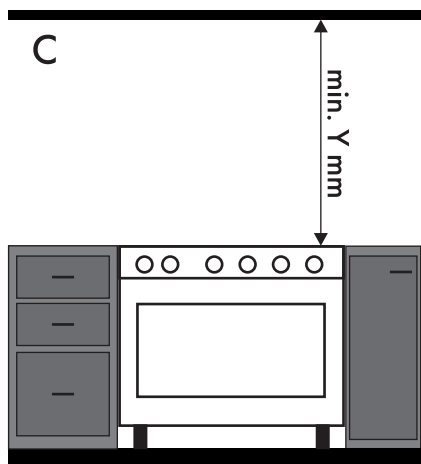

**C - Class 2 subclass 1**  
(Built-in appliance)

## Appliance overall dimensions

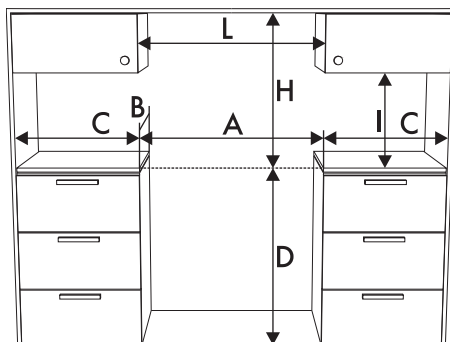

|                      |              |
|----------------------|--------------|
| <b>A</b>             | 900 mm       |
| <b>B</b>             | 600 mm       |
| <b>C<sup>1</sup></b> | min. 150 mm  |
| <b>D</b>             | 900 - 915 mm |
| <b>H</b>             | 750 mm       |
| <b>I</b>             | 450 mm       |
| <b>L<sup>2</sup></b> | 900 mm       |

<sup>1</sup> Minimum distance from side walls or other flammable material.

<sup>2</sup> Minimum cabinet width (=A).



The appliance must be installed by a qualified technician and according to the regulations in force.





## Dimensions of the appliance: locations of gas and electric connections (mm)

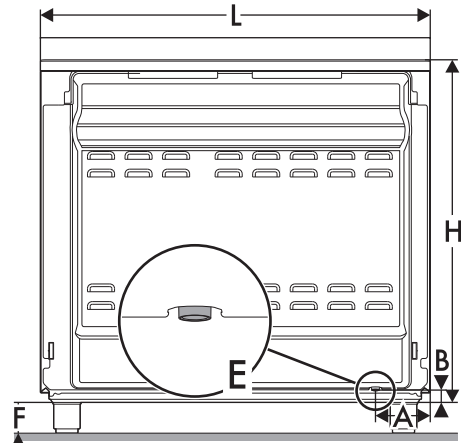

|          |                   |
|----------|-------------------|
| <b>A</b> | 124               |
| <b>B</b> | 38                |
| <b>F</b> | min 105 - max 160 |
| <b>H</b> | 776               |
| <b>L</b> | 898               |

**E** = Electrical connection

## Positioning and levelling



Heavy appliance

Risk of damage to the appliance

- Insert the front feet first and then the rear ones.
- After making the gas and electrical connections, screw on the four feet supplied with the appliance.

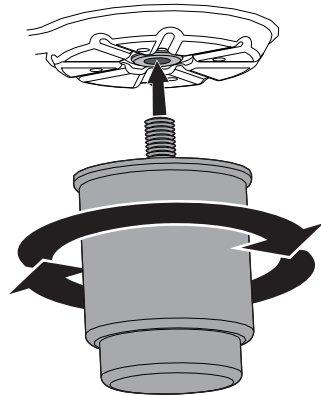

The appliance must sit level on the floor to ensure stability.

- Screw or unscrew the bottom part of the foot until the appliance is stable and level on the floor.

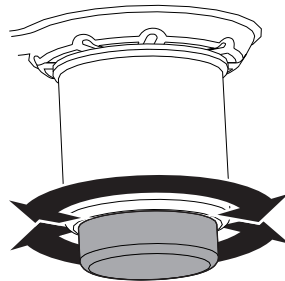



# Installation

## Fastening to the wall



The anti-tip devices must be installed in order to prevent the appliance from tipping over.

1. Screw the wall fastening plate to the rear of the appliance.

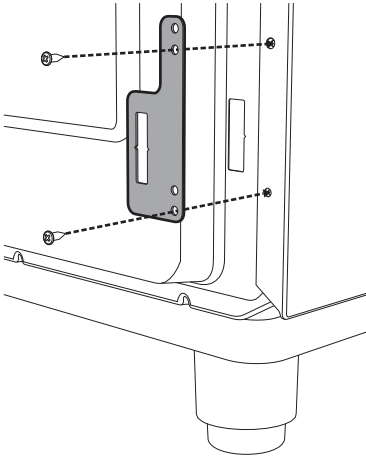

2. Adjust the height of the 4 feet.

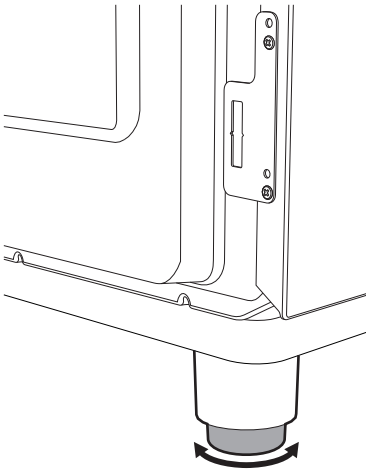

3. Assemble the fastening bracket.

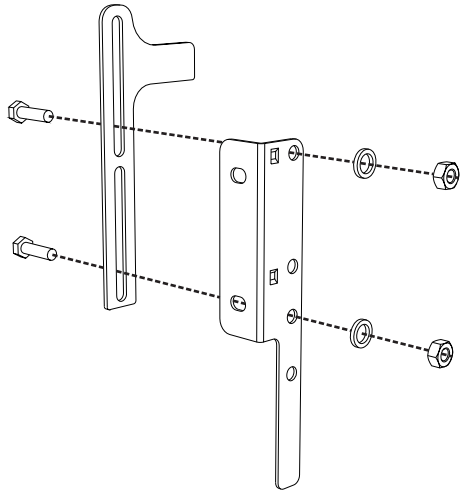

4. Align the base of the hook on the fastening bracket with the base of the slot on the wall fastening plate.

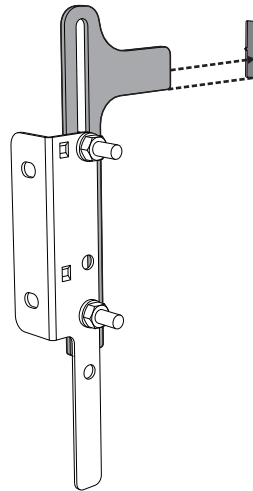



- Align the base of the fastening bracket with the ground and tighten the screws to fix the measurements.

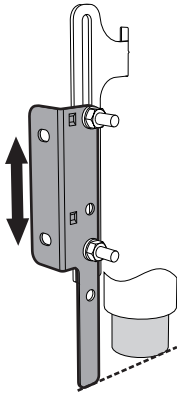

- Move the bracket onto the wall and mark the position of the holes to be drilled in the wall.

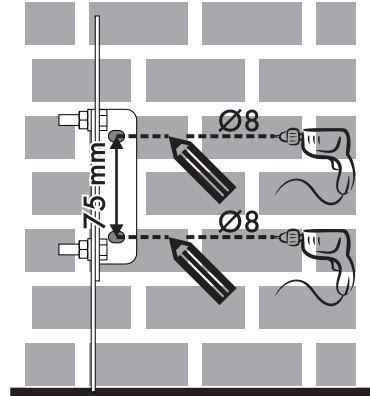

- Use 50 mm for the distance from the side of the appliance to the bracket holes.

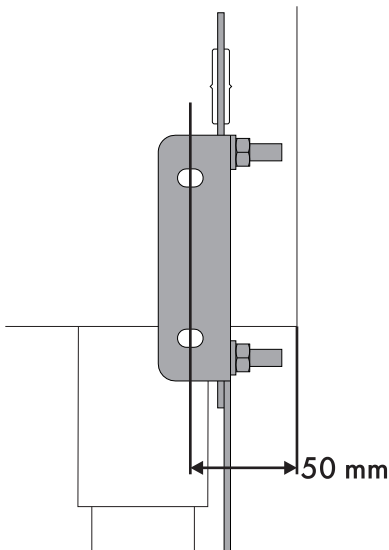

- After drilling the holes in the wall, use wall plugs and screws to fasten the bracket to the wall.
- Push the cooker towards the wall, and at the same time, insert the bracket in the plate fastened to the rear of the appliance.

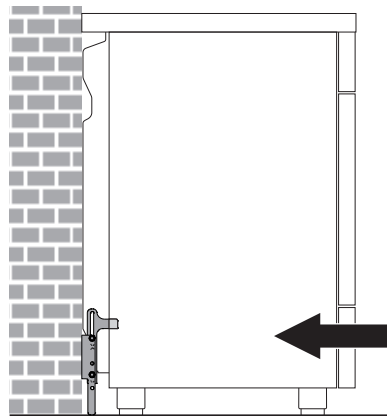



# Installation

## 5.2 Electrical connection



**Power voltage  
Danger of electrocution**

- Have the electrical connection performed by authorised technicians.
- Use personal protective equipment.
- The appliance must be connected to ground in compliance with electrical system safety standards.
- Disconnect the mains power supply.
- Use cables withstanding a temperature of at least 90°C.
- The tightening torque of the screws of the terminal board leads must be 1.5 - 2 Nm.

### General information

Check the mains characteristics against the data indicated on the plate.

The identification plate bearing the technical data, serial number and brand name is visibly positioned on the appliance.

Do not remove this plate for any reason.

Perform the ground connection using a wire that is 20 mm longer than the other wires.

The appliance can work in the following modes:

- **220-240 V 2~**

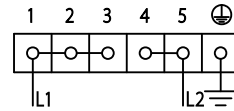

- **3 x 10 mm<sup>2</sup> three-core cable.**

- **220-240 V 3~**

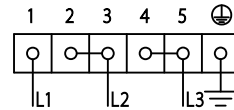

- **4 x 4 mm<sup>2</sup> four-core cable.**

- **220-240 V 1N~**

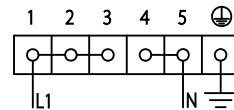

- **3 x 10 mm<sup>2</sup> three-core cable.**

- **380-415 V 2N~**

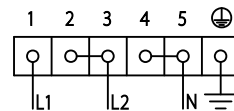

- **4 x 4 mm<sup>2</sup> four-core cable.**

- **380-415 V 3N~**

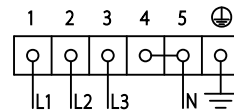

- **5 x 1.5 mm<sup>2</sup> five-core cable.**



The values indicated above refer to the cross-section of the internal lead.



The aforementioned power cables are sized taking into account the coincidence factor (in compliance with standard EN 60335-2-6).

## Metal cable clamp

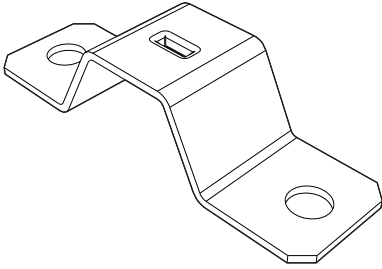

If you use a **3 x 10 mm<sup>2</sup>** cable, you should replace the plastic cable clamp with the metal cable clamp provided.

## Fixed connection

Fit the power line with an all-pole disconnection switch, with a clearance between its contacts that allows the complete disconnection as per the overvoltage category III, in compliance with the installation regulations.

## Access to the terminal board

To connect the power supply cable, access to the terminal board on the rear cover:

1. Remove the screws securing the lid to the rear cover.

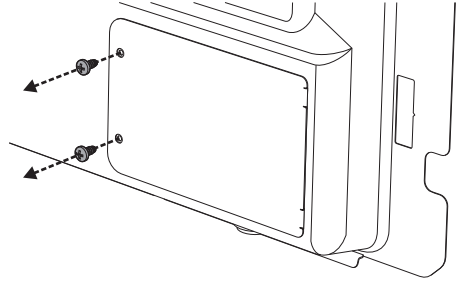

2. Slightly turn the lid and remove it from its housing.

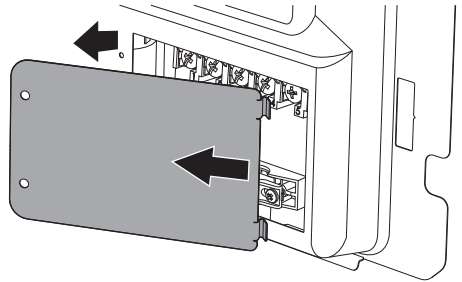

3. Install the power supply cable.

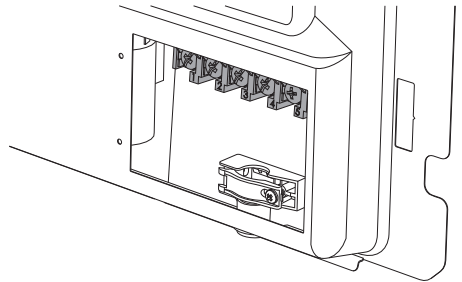



Loosen the cable fastener screw before installing the power supply cable.

4. At the end, reposition the lid on the rear cover and secure it with the previously removed screws.

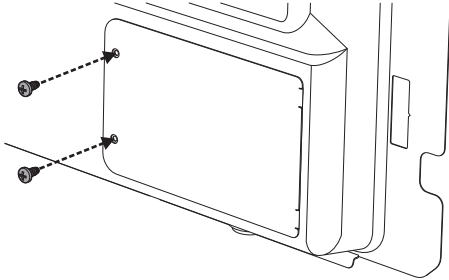

## 5.3 Instructions for the installer

- Do not bend or trap the power cable.
- The appliance must be installed according to the installation diagrams.
- If the appliance does not work correctly after having carried out all the checks, contact your local Authorised Service Centre.
- Once the appliance has been installed, please explain to the user how to use it correctly.