



DOLCE & GABBANA

INSTRUCTION MANUAL

INSTRUCTION MANUAL

KETTLE

دليل التعليمات
غلاية

AR EN



Important information for the user معلومات هامة للمستخدم



Recommendations / تحذيرات



Description / الوصف



Use / الإستعمال



Cleaning and care / التنظيف و الصيانة



Safety instructions / تحذير للسلامة



Information / معلومات



Advice / اقتراحات

Dear Customer, Thank you for choosing this special edition Smeg – Dolce&Gabbana, Blu Mediterraneo small domestic appliance. Smeg and Dolce&Gabbana have combined their artistic talents to create a unique collection, made in Italy by Smeg with unmistakable Dolce&Gabbana design touches. We hope you enjoy using your new appliance! Kindest regards.

نشكرك على اختيار هذا الإصدار الخاص من Smeg – Dolce&Gabbana Blu Mediterraneo. قامت شركتي Smeg – Dolce&Gabbana بدمج مواهبهما الفنية لإخراج تشكيلة فريدة من نوعها، مصنوعة في إيطاليا بواسطة شركة Smeg وباللمسات التصميمية الخالية من الأخطاء لشركة Dolce&Gabbana. نأمل أن تستمتع باستخدام هذا الجهاز الجديد! مع أطيب التمنيات

SMEG S.p.A.

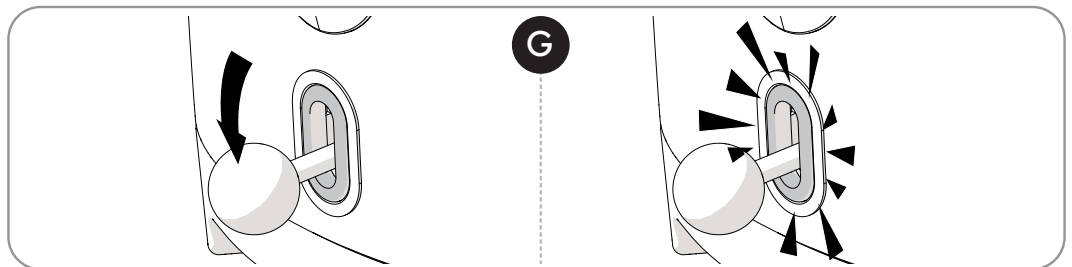
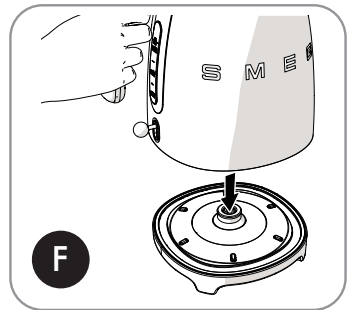
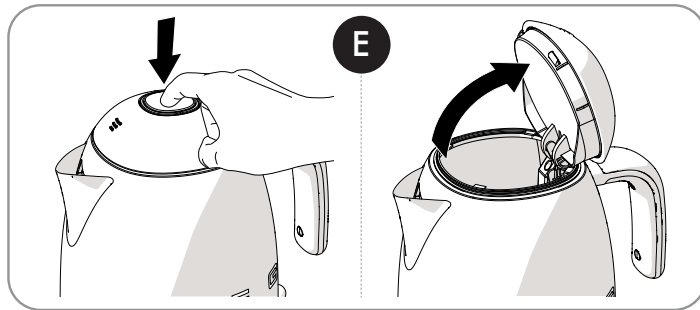
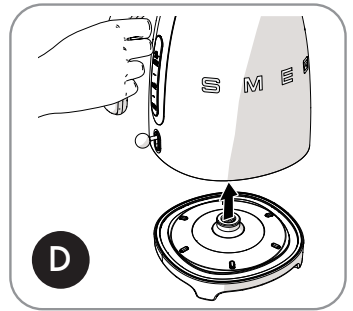
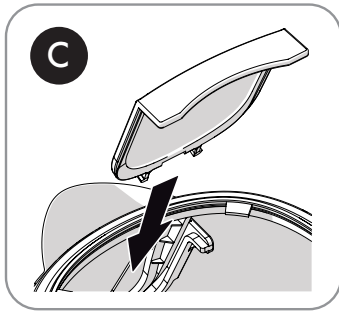
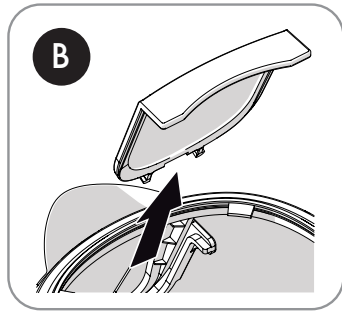
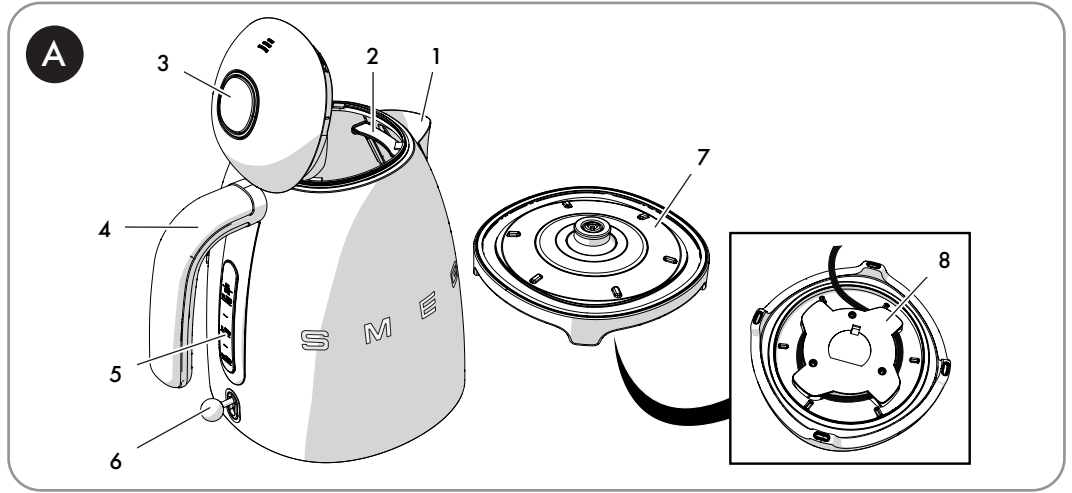



1 Instructions

This user manual is an integral part of the appliance and must therefore be kept in its entirety and within the user's reach for the whole working life of the appliance.

1.1 Intended use

- Only use the appliance indoors and at a maximum altitude of 2000 metres.
- This appliance is intended for household use and similar applications such as:
 - staff kitchen areas in shops, offices and other working environments
 - bed and breakfast facilities / farm accommodation
 - by guests in hotels, motels and other residential accommodations;
- Any other use, for example in restaurants, coffee bars and coffee shops is considered improper.
- Only use the appliance to heat water. Never fill the kettle with other liquids.
- This appliance may be used by people of reduced physical, sensory or mental abilities (including children over the age of 8), only if they are supervised by adults or have been trained on how to use the appliance safely and have understood the dangers associated with its use.
- Children must never play with the appliance.
- Keep the appliance and its cord out of reach of children aged less than 8 years.
- Cleaning and maintenance may be carried out by children who are at least 8 years old only if they are supervised by an adult.

1.2 General safety instructions

- Do not immerse the appliance, the power cord, the plug or the base in water or any other liquid. Do not unplug the appliance with wet hands, or by pulling on the power cord.
- Never wash the appliance in the dishwasher.
- Regarding the instructions for cleaning, please refer to the chapter "Cleaning and maintenance."
- Do not position the appliance above hot surfaces, hob burners, or inside a hot oven.
- In the event of a fault, or if the power cable is damaged, the appliance must be repaired only by a qualified technician or an authorised technical support centre.
- Any modifications to the appliance will make the warranty invalid.

1.3 Caution

- Do not use the kettle if the handle is loose.
- Make sure that the inside bottom of the kettle is completely covered with water before switching it on.
- Only use the kettle with the base provided.
- Make sure that the lid is correctly closed before switching on the kettle.



Instructions

- Only use original spare parts. The use of spare parts not approved by the manufacturer could lead to fires, electric shocks or personal injury.
- Due to the special processing of the decals and the special finish of the product, you may notice a slight odour when using the kettle for first time. This odour is related exclusively to the decoration of the product. It does not affect the functionality or integrity of the product and does not pose a risk to safety.

1.4 Manufacturer liability

The manufacturer declines any liability for damage to persons or property caused by:

- Use of the appliance other than the one envisaged
- Not having read the user manual
- Tampering with any part of the appliance
- Use of non-original spare parts
- Failure to comply with the safety instructions

1.5 Disposal



This appliance must be disposed of separately from other waste (Directive 2012/19/EU).

- The appliance does not contain substances in quantities sufficient to be considered hazardous to health and the environment, in accordance with current European directives.
- Old electrical appliances must not be disposed of together with household waste! To comply with current legislation, old appliances, on reaching the end of their useful lives, should be taken to a disposal facility where they can be sorted. The relevant local authorities or their waste disposal operators can provide further information.
- Take these packing materials to the appropriate recycling centre.

Instructions



Fire hazard:

- Do not position the appliance above hot surfaces, hob burners, or inside a hot oven.



Risk of injury:

- Improper use of the appliance can cause injury.



Danger of burns:

- Do not overfill the kettle (maximum capacity 1.7 litres) to avoid boiling water from being splashed out.
- The surfaces of the kettle may become very hot. Avoid touching hot surfaces; use the handle.
- Wait a few seconds after the kettle has reached boiling temperature, then pour the water out slowly to prevent hot water from spraying or coming out too fast.
- Do not tilt the hot kettle excessively – the boiling water could spray out, with a risk of burns.
- Keep your face at safe distance from the lid to avoid the risk of scalding from escaping steam.
- Let the appliance cool down before cleaning.
- Pay attention: The heating element surface is subject to residual heat after use.



Danger of electrocution:

- Plug into an grounded 3-prong outlet.
- Do not remove the earth prong.
- Do not use an adapter.
- Do not use an extension cord.
- Avoid spilling liquids onto the power plug and base.
- Unplug the kettle when it is not being used, before cleaning and if you notice any fault.
- Failure to follow these instructions could result in death, fire, or electrical shock.



Caution

- To clean surfaces that come into contact with food, follow the special cleaning procedures provided in the instructions.



Suffocation hazard due to plastic packaging:

- Do not leave the packaging or any part of it unattended.
- Do not let children play with the plastic bags.



2 Product description (Fig. A)

- 1) Anti-drip spout
- 2) Scale filter
- 3) Lid with push-push opening
- 4) Handle
- 5) Water level indicator
- 6) ON/OFF lever with indicator light
- 7) Cordless base with 360° operation
- 8) Cable compartment (under base)



To avoid damaging the appliance, the kettle is equipped with a safety device that automatically turns the lever to the OFF position if the kettle is accidentally switched on without water.

If this occurs, let the kettle cool down before starting the boiling cycle again.

3 Use

3.1 Before first use

- 1) Remove any sticker from the kettle and clean the outside with a damp cloth.
- 2) Remove the scale filter behind the spout (Fig. B) and wash it under running water.
- 3) Replace the filter in the correct position (Fig. C).
- 4) Remove the kettle from its base (Fig. D), press the button to open the lid (Fig. E) and fill it to the maximum level (5 - Fig. A).
- 5) Close the lid, place the kettle on its base (Fig. F) and push the lever down to turn it on (Fig. G).
- 6) Wait for the water to boil, then empty the kettle, disposing of the boiling water safely. Repeat this operation at least three times.

3.2 Operation

If necessary, wrap the cable under the base (7 and 8 - Fig. A).

Always use the handle (4 - Fig. A) to lift the kettle and pour out the water.

- 1) To begin, remove the kettle from the base (Fig. D), press the button to open the lid (Fig. E) and fill with water, using the level indicator (5 - Fig. A) as a reference. Avoid filling it with too much or too little water as indicated by the maximum or minimum level indicators.
- 2) Close the lid and place the kettle back on its base (Fig. F).
- 3) Then place the plug into the power socket.
- 4) Push the lever downwards to turn the kettle on. The LED lights up and becomes white (Fig. G).
- 5) When the water boils, the lever automatically moves into the OFF position and the LED switches off. Pour out the water.



4 Cleaning and maintenance

4.1 Cleaning the surfaces

To keep the outside surfaces of the kettle in good condition, clean them regularly after use after allowing them to cool down.

Pour the product onto a damp cloth and clean the surface, wipe thoroughly once more and then dry with a soft cloth or a microfibre cloth.

Improper use (risk of damage to surfaces):

- Do not use steam jets to clean the appliance.
- Do not use cleaning products containing chlorine, ammonia or bleach.
- Do not use abrasive or corrosive detergents (e.g. powder products, stain removers and metallic scourers).
- Do not use rough or abrasive materials or sharp metal scrapers.

4.2 Cleaning the filter

- 1) Open the lid (Fig. E) and extract the filter (Fig. B).
- 2) Wash the filter under running water with the aid of a soft brush.
- 3) Put the filter back in position behind the spout (Fig. C).

4.3 Descaling

Improper use: Risk of damaging the appliance

i Do not use descaling products for cleaning bathrooms or kitchens or products that contain perfumes.

Regularly removing scale deposits from inside the kettle will prolong your kettle's life, ensuring maximum performance and energy savings.

The kettle can be descaled using specific descaling products. Follow the descaler instructions.

Alternatively, you can use common household vinegar. Proceed as follows:

- 1) Fill the kettle with water (1 litre) and boil it.
- 2) Add white vinegar (0.1 to 0.5 litres depending on the amount of scale).
- 3) Leave it to act overnight.
- 4) Empty the kettle.
- 5) Fill the kettle with water and boil it. Empty the kettle, disposing of the water safely. Repeat this operation at least twice.



Tips and suggestions for the user

Frequent use or very hard water increases the risk of scale.

Scale build-up can cause the kettle to switch off during use before the water has boiled.

Boiling times could also increase.

If the kettle is used daily, descale it more frequently. If the water is hard, clean more frequently or use purified water.



Cleaning and maintenance

4.4 What to do if...

Problem	Cause	Solution
Pouring water becomes more difficult	Scale build-up on filter	Check that the filter is clean and correctly positioned
The kettle turns off before boiling	The base of the kettle has excessive scale build-up	Descale more frequently
	There is too little water in the kettle	Increase the quantity of water until you reach at least the minimum level
The appliance does not turn on	The safety device has tripped out due to the kettle being operated without water	Let the kettle cool down before attempting to boil water again
	The plug is not properly inserted in the power socket	Insert the plug into the power socket. Do not use adaptors or extensions. Make sure that the main circuit breaker is on
	The cable is defective	Have the cable replaced at an Authorised Service Centre
	Lack of power	Make sure that the main circuit breaker is on

The manufacturer reserves the right to make any changes deemed necessary for the improvement of its products without prior notice. The illustrations and descriptions contained in this manual are therefore not binding and are merely indicative.

عميلنا العزيز، شكرًا لك على شراء أحد أجهزتنا. تعد منتجاتنا فريدة لأنها تجمع بين الأسلوب المميز والحلول التقنية المبتكرة. وهي تتناسب تمامًا مع المنتجات الأخرى في مجموعتنا وتعمل بنفس القدر كتصميمات قائمة بذاتها في مطبخك. نأمل أن تستمتع باستخدام هذا الجهاز الجديد! وتفضلوا بقبول وافر الاحترام والتقدير.