



FA 120 E

en	Instruction Manual
it	Manuale di istruzioni
pt	Manual de Instruções
nl	Gebruiksaanwijzing
fr	Notice d'Utilisation
sv	Bruksanvisning
es	Manual de instrucciones
de	Bedienungsanleitung



Please read this user manual first!

Dear Customer,

We hope that your product, which has been produced in modern plants and checked under the most meticulous quality control procedures, will provide you an effective service.

Therefore, read this entire user manual carefully before using the product and keep it as a reference. If you handover the product to someone else, give the user manual as well.

The user manual will help you use the product in a fast and safe way.

- Read the manual before installing and operating the product.
- Make sure you read the safety instructions.
- Keep the manual in an easily accessible place as you may need it later.
- Read the other documents given with the product.

Remember that this user manual is also applicable for several other models. Differences between models will be identified in the manual.

Explanation of symbols

Throughout this user manual the following symbols are used:

 Important information or useful tips.

 Warning against dangerous conditions for life and property.

 Warning against electric voltage.

CUSTOMER CARE AND SERVICE

Always use original spare parts.

When contacting our Authorised Service Centre, ensure that you have the following data available: Model, Serial Number.

The information can be found on the rating plate.

 Warning / Caution-Safety information

 General information and tips





 Environmental information

VISIT OUR WEBSITE TO:



service

Get usage advice, brochures, trouble shooter, service and repair information: www.smeg.com/services/customer-service

 INFORMATION	
	
SUPPLIER'S NAME 	MODEL IDENTIFIER (*) 
The model information as stored in the product data base can be reached by entering following website and searching for your model identifier (*) found on energy label. https://eprel.ec.europa.eu/	

CONTENTS

1 Your cooler/freezer	4	4 Preparation	12
2 Safety and Environment Instructions	5	Hints and Tips	12
General Safety	5	Reversing the doors	15
Intended Use	7	5 Using your cooler/freezer	17
Child Safety	8	Freezing food.....	17
Compliance with WEEE Directive and Disposing of the Waste Product.....	8	Making ice cubes	18
Compliance with RoHS Directive	8	Defrosting of the appliance	18
Package Information.....	8	Cooling.....	19
3 Installation	9	Food storage.....	19
Points to be paid attention to when the relocation of the cooler/freezer.....	9	Defrosting of the appliance	19
Before you start the cooler/freezer, ...	9	6 Maintenance and cleaning	20
Electrical connection.....	9	Protection of plastic surfaces	20
Disposing of the packaging	10	7 Troubleshooting	21
Disposing of your old cooler/freezer.	10		
Placing and Installation	10		
Adjusting the legs	11		
Changing the illumination lamp	11		

1 Your cooler/freezer

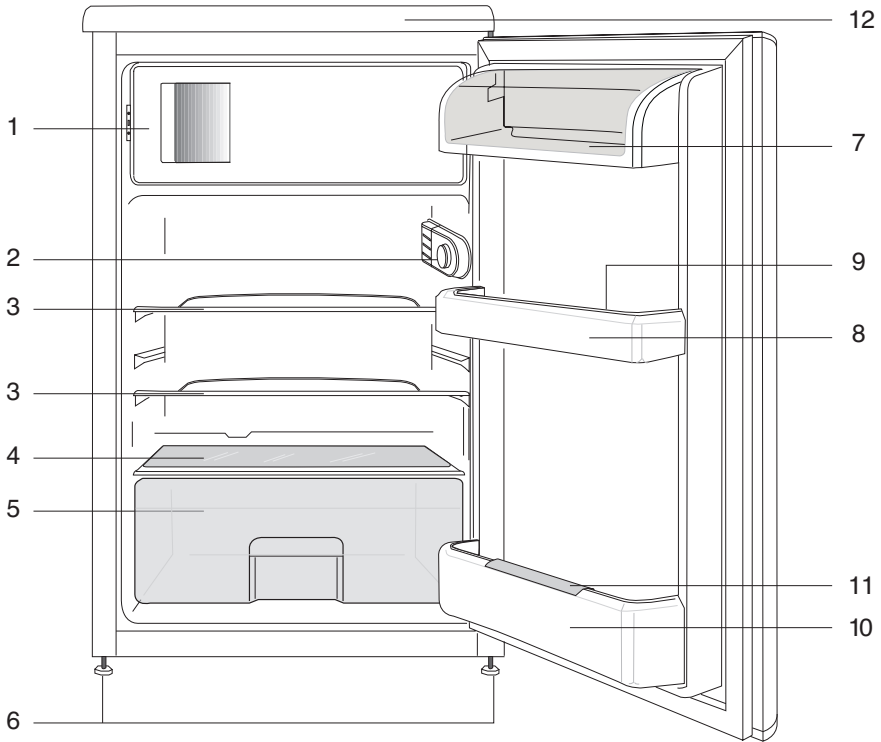





- 1. a.) Freezing compartment & ice tray (for models) b.) Frozen food compartment & ice tray (for models)
- 2. Interior light & Thermostat knob
- 3. Movable shelves
- 4. Crisper cover
- 5. Crisper
- 6. Adjustable front feet
- 7. Dairy compartment
- 8. Door shelf
- 9. Egg tray
- 10. Bottle shelf
- 11. Bottle gripper
- 12. Top trim

Figures that take place in this instruction manual are schematic and may not correspond exactly with your product. If the subject parts are not included in the product you have purchased, then it is valid for other models.

This section provides the safety instructions necessary to prevent the risk of injury and material damage. Failure to observe these instructions will invalidate all types of product warranty.

Intended use

	<p>WARNING: Keep ventilation openings, in the appliance enclosure or in the built-in structure, clear of obstruction.</p>
	<p>WARNING: Do not use mechanical devices or other means to accelerate the defrosting process, other than those recommended by the manufacturer.</p>
	<p>WARNING: Do not damage the refrigerant circuit.</p>
	<p>WARNING: Do not use electrical appliances inside the food storage compartments of the appliance, unless they are of the type recommended by the manufacturer.</p>
	<p>WARNING: Do not store explosive substances such as aerosol cans with a flammable propellant in this appliance.</p>

This appliance is intended to be used in household and similar applications such as

- staff kitchen areas in shops, offices and other working environments;
- farm houses and by clients in hotels, motels and other residential type

environments;

- bed and breakfast type environments;
- catering and similar non-retail applications.

General Safety

- This product should not be used by persons with physical, sensory and mental disabilities, without sufficient knowledge and experience or by children. The device can only be used by such persons under supervision and instruction of a person responsible for their safety. Children should not be allowed to play with this device.
- In case of malfunction, unplug the device.
- After unplugging, wait at least 5 minutes before plugging in again.
- Unplug the product when not in use.
- Do not touch the plug with wet hands! Do not pull the cable to plug off, always hold the plug.
- Do not plug in the refrigerator if the socket is loose.
- Unplug the product during installation, maintenance, cleaning and repair.
- If the product will not be used for a while, unplug the product and remove any food inside.
- Do not use the product when the compartment with circuit cards located on the upper back part of the product (electrical card box cover) (1) is open.

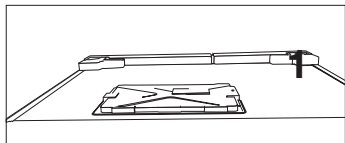
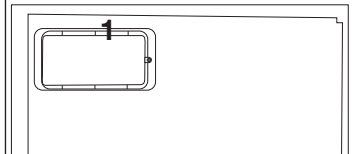

- Do not use steam or steamed cleaning materials for cleaning the refrigerator and melting the ice inside. Steam may contact the electrified areas and cause short circuit or electric shock!
- Do not wash the product by spraying or pouring water on it! Danger of electric shock!
- In case of malfunction, do not use the product, as it may cause electric shock. Contact the authorized service before doing anything.
- Plug the product into an earthed socket. Earthing must be done by a qualified electrician.
- If the product has LED type lighting, contact the authorized service for replacing or in case of any problem.
- Do not touch frozen food with wet hands! It may adhere to your hands!
- Do not place liquids in bottles and cans into the freezer compartment. They may burst out!
- Place liquids in upright position after tightly closing the lid.
- Do not spray flammable substances near the product, as it may burn or explode.
- Do not keep flammable materials and products with flammable gas (sprays, etc.) in the refrigerator.
- Do not place containers holding liquids on top of the product.

Splashing water on an electrified part may cause electric shock and risk of fire.

- Exposing the product to rain, snow, sunlight and wind will cause electrical danger. When relocating the product, do not pull by holding the door handle. The handle may come off.
- Take care to avoid trapping any part of your hands or body in any of the moving parts inside the product.
- Do not step or lean on the door, drawers and similar parts of the refrigerator. This will cause the product to fall down and cause damage to the parts.
- Take care not to trap the power cable.

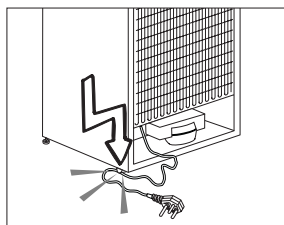

- When positioning the appliance, ensure the supply cord is not trapped or damaged.
- Do not locate multiple portable socket-outlets or portable power supplies at the rear of the appliance.
- Children aged from 3 to 8 years are allowed to load and unload refrigerating appliances.
- To avoid contamination of food, please respect the following instructions:

- – Opening the door for long periods can cause a significant increase of the temperature in the compartments of the appliance.
- – Clean regularly surfaces that can come in contact with food and accessible drainage systems.
- – Clean water tanks if they have not been used for 48 h; flush the water system connected to a water supply if water has not been drawn for 5 days.
- – Store raw meat and fish in suitable containers in the refrigerator, so that it is not in contact with or drip onto other food.
- – Two-star frozen-food compartments are suitable for storing pre-frozen food, storing or making icecream and making ice cubes.
- – One-, two- and three-star compartments are not suitable for the freezing of fresh food.
- – If the refrigerating appliance is left empty for long periods, switch off, defrost, clean, dry, and leave the door open to prevent mould developing within the appliance.

1.1.1 HC Warning

If the product comprises a cooling system using R600a gas, take care to avoid damaging the cooling system and its pipe while using and moving the product. This gas is flammable. If the cooling system is damaged, keep the product away from sources of fire and ventilate the room immediately.



The label on the inner left side indicates the type of gas used in the product.

1.1.2 For Models with Water Dispenser

- Pressure for cold water inlet shall be maximum 90 psi (6.2 bar). If your water pressure exceeds 80 psi (5.5 bar), use a pressure limiting valve in your mains system. If you do not know how to check your water pressure, ask for the help of a professional plumber.
- If there is risk of water hammer effect in your installation, always use a water hammer prevention equipment in your installation. Consult Professional plumbers if you are not sure that there is no water hammer effect in your installation.
- Do not install on the hot water inlet. Take precautions against of the risk of freezing of the hoses. Water temperature operating interval shall be 33°F (0.6°C) minimum and 100°F (38°C) maximum.
- Use drinking water only.

Intended Use

- This product is designed for home use. It is not intended for commercial use.
- The product should be used to store food and beverages only.
- Do not keep sensitive products requiring controlled temperatures (vaccines, heat sensitive medication, medical supplies, etc.) in the refrigerator.
- The manufacturer assumes no responsibility for any damage due to misuse or mishandling.
- Original spare parts will be provided for 10 years, following the product purchasing date.

Child Safety

- Keep packaging materials out of children's reach.
- Do not allow the children to play with the product.
- If the product's door comprises a lock, keep the key out of children's reach.

Compliance with WEEE Directive and Disposing of the Waste Product

This product complies with EU WEEE Directive (2012/19/EU). This product bears a classification symbol for waste electrical and electronic equipment (WEEE).

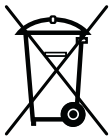

This product has been manufactured with high quality parts and materials which can be reused and are suitable for recycling. Do not dispose of the waste product with normal

domestic and other wastes at the end of its service life. Take it to the collection center for the recycling of electrical and electronic equipment. Please consult your local authorities to learn about these collection centers.

Compliance with RoHS Directive

- This product complies with EU WEEE Directive (2011/65/EU). It does not contain harmful and prohibited materials specified in the Directive.

Package Information

Packaging materials of the product are manufactured from recyclable materials in accordance with our National Environment Regulations. Do not dispose of the packaging materials together with the domestic or other wastes. Take them to the packaging material collection points designated by the local authorities.

Service

- To repair the appliance contact the Authorised Service Centre. Use original spare parts only.
- Please note that self-repair or nonprofessional repair can have safety consequences and might void the guarantee.
- The following spare parts will be available for 7 years after the model has been discontinued: thermostats, temperature sensors, printed circuit boards, light sources, door handles, door hinges, trays and baskets. Please note that some of these spare parts are only available to professional repairers, and that not all spare parts are relevant for all models.
- Door gaskets will be available for 10 years after the model has been discontinued.

3 Installation

⚠ The manufacturer will not be liable for any event caused by disregarding the information supplied in this user manual.

Points to be paid attention to when the relocation of the cooler/freezer

1. Your cooler/freezer should be unplugged. Before transportation of your cooler/freezer, it should be emptied and cleaned.
2. Before it is re-packaged, shelves, accessories, crisper, etc. inside your cooler/freezer should be fixed with adhesive tape and secured against impacts. Package should be bound with a thick tape and the transportation rules on the package should be strictly observed.
3. Original packaging and foam materials should be kept for future transportations or moving.

Before you start the cooler/freezer,

Check the following before you start to use your cooler/freezer:

1. Attach 2 plastic wedges as illustrated below. Plastic wedges are intended to keep the distance which will ensure the air circulation between your cooler/freezer and the wall. (The picture is drawn up as a representation and it is not identical with your product.)
2. Clean the interior of the cooler/freezer as recommended in the "Maintenance and cleaning" section.

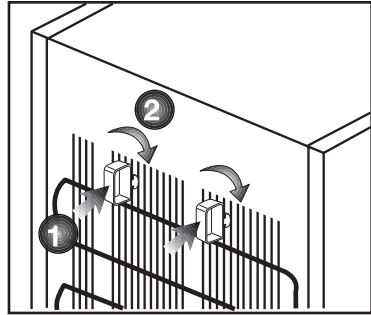

3. Connect the plug of the cooler/freezer to the wall socket. When the fridge door is opened, fridge internal lamp will turn on.
4. When the compressor starts to operate, a sound will be heard. The liquid and gases sealed within the refrigeration system may also give rise to noise, even if the compressor is not running and this is quite normal.
5. Front edges of the cooler/freezer may feel warm. This is normal. These areas are designed to be warm to avoid condensation.

Electrical connection

Connect your product to a grounded socket which is being protected by a fuse with the appropriate capacity.

Important:

The connection must be in compliance with national regulations.

- The power plug must be easily accessible after installation.
- Electrical safety of your cooler/freezer shall be guaranteed only if the earth system in your house complies with standards.

- The voltage stated on the label located at left inner side of your product should be equal to your network voltage.
- **Extension cables and multi plugs must not be used for connection.**

⚠ A damaged power cable must be replaced by a qualified electrician.

⚠ Faulty product must not be operated before it is repaired! There is the risk of electric shock!

Disposing of the packaging

The packing materials may be dangerous for children. Keep the packing materials out of the reach of children or dispose of them by classifying them in accordance with the waste instructions stated by your local authorities. Do not throw away with regular house waste, throw away on packaging pick up spots designated by the local authorities.

The packing of your cooler/freezer is produced from recyclable materials.

Disposing of your old cooler/freezer

Dispose of your old cooler/freezer without giving any harm to the environment.

- You may consult your authorized dealer or waste collection center of your municipality about the disposal of your cooler/freezer.

Before disposing of your cooler/freezer, cut out the electric plug and, if there are any locks on the door, make them inoperable in order to protect children against any danger.

Placing and Installation

⚠ If the entrance door of the room where the cooler/freezer will be installed is not wide enough for the cooler/freezer to pass through, then carefully remove the doors of your cooler/freezer and pass it sideways through the door.

1. Install your cooler/freezer to a place that allows ease of use.
2. Keep your cooler/freezer away from heat sources, humid places and direct sunlight.
3. There must be appropriate air ventilation around your cooler/freezer in order to achieve an efficient operation. If the cooler/freezer is to be placed in a recess in the wall, there must be at least 5 cm distance with the ceiling and at least 5 cm with the wall. Do not place your product on the materials such as rug or carpet.
4. Place your cooler/freezer on an even floor surface to prevent jolts.

WARNING:

Do not locate extension sockets or charging transformers/power supplies or Lithium-Iron battery operated products adjacent to the compressor as they could overheat.

If your appliance is equipped with an air grille, please refer for installation of the air grille.

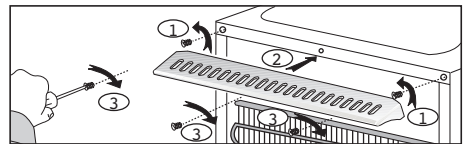

Adjusting the legs

If your refrigerator is unbalanced;

You can balance your refrigerator by turning its front legs as illustrated in the figure. The corner where the leg exists is lowered when you turn in the direction of black arrow and raised when you turn in the opposite direction. Taking help from someone to slightly lift the refrigerator will facilitate this process.

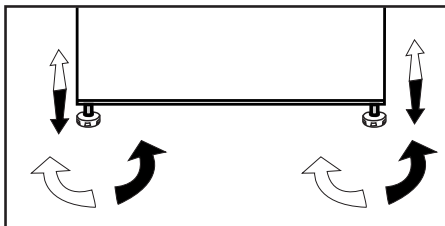

Changing the illumination lamp

To change the Bulb/LED used for illumination of your refrigerator, call your AuthorisedService.

The lamp(s) used in this appliance is not suitable for household room illumination. The intended purpose of this lamp is to assist the user to place foodstuffs in the refrigerator/freezer in a safe and comfortable way. The lamps used in this appliance have to withstand extreme physical conditions such as temperatures below -20°C .

(only chest and upright freezer)

This product is equipped with a lighting source of the "G" energy class.

The lighting source in this product shall only be replaced by professional repairers.

Positioning

This appliance should be installed in a dry, well ventilated indoor position.

This appliance is intended to be used at ambient temperature ranging from 10°C to 43°C .

4 Preparation

- For a freestanding appliance; ‘this refrigerating appliance is not intended to be used as a built-in appliance’ ;.
- Your cooler/freezer should be installed at least 30 cm away from heat sources such as hobs, ovens, central heater and stoves and at least 5 cm away from electrical ovens and should not be located under direct sunlight.
- The ambient temperature of the room where you install your cooler/freezer should at least be 10°C. Operating your cooler/freezer under cooler conditions is not recommended with regard to its efficiency.
- Please make sure that the interior of your cooler/freezer is cleaned thoroughly.
- If two cooler/freezers are to be installed side by side, there should be at least 4 cm distance between them.
- When you operate your cooler/freezer for the first time, please observe the following instructions during the initial six hours.
- The door should not be opened frequently.
- It must be operated empty without any food in it.
- Do not unplug your cooler/freezer. If a power failure occurs out of your control, please see the warnings in the “Recommended solutions for the problems” section.
- Original packaging and foam materials should be kept for future transportations or moving.

Hints and Tips

Hints for energy saving

- Most efficient use of energy is ensured in the configuration with the drawers in the bottom part of the appliance and shelves evenly distributed. Position of the door bins does not affect energy consumption.
- Do not open the door frequently or leave it open longer than necessary.
- Do not set too high temperature to save energy unless it is required by the characteristics of the food.
- If the ambient temperature is high and the temperature control is set to low temperature and the appliance is fully loaded, the compressor may run continuously, causing frost or ice formation on the evaporator. In this case, set the temperature control toward higher temperature to allow automatic defrosting and to save energy this way.
- Ensure a good ventilation. Do not cover the ventilation grilles or holes.

Hints for fresh food refrigeration

- Good temperature setting that ensures preservation of fresh food is a temperature less than or equal to +4°C.
- Higher temperature setting inside the appliance may lead to shorter shelf life of food.
- Cover the food with packaging to preserve its freshness and aroma.

- Always use closed containers for liquids and for food, to avoid flavours or odours in the compartment.
- To avoid the cross-contamination between cooked and raw food, cover the cooked food and separate it from the raw one.
- It is recommended to defrost the food inside the fridge.
- Do not insert hot food inside the appliance. Make sure it has cooled down at room temperature before inserting it.
- To prevent food waste the new stock of food should always be placed behind the old one.

Hints for food refrigeration

- Meat (all types): wrap in a suitable packaging and place it on the glass shelf above the vegetable drawer. Store meat for at most 1 -2 days.

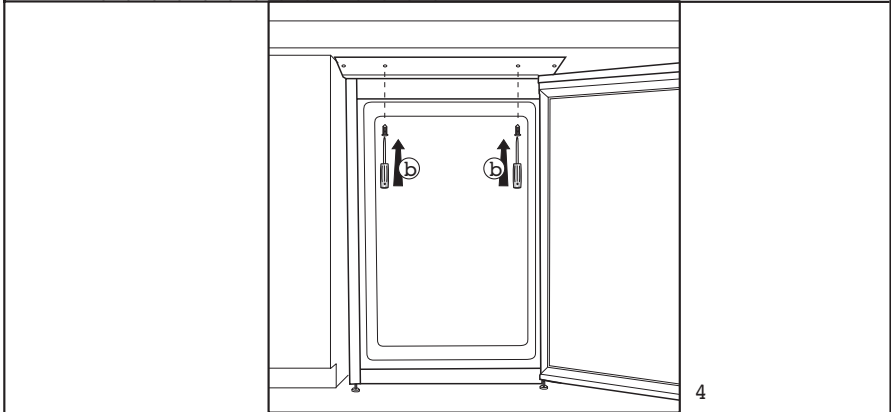
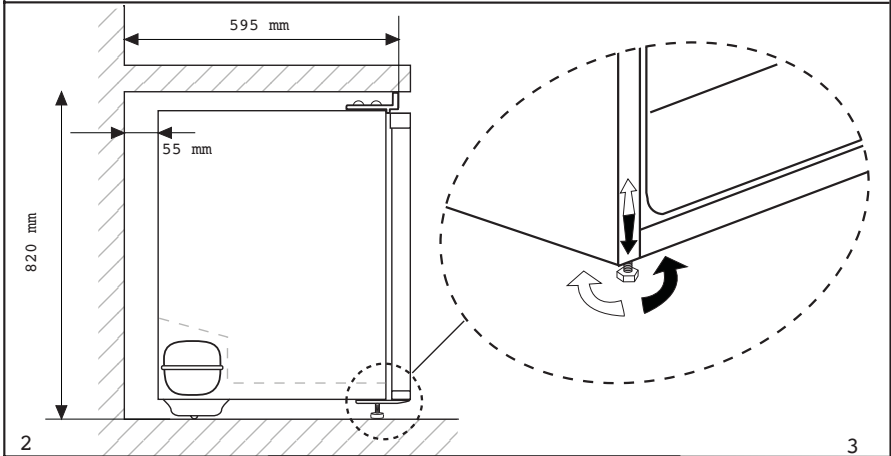
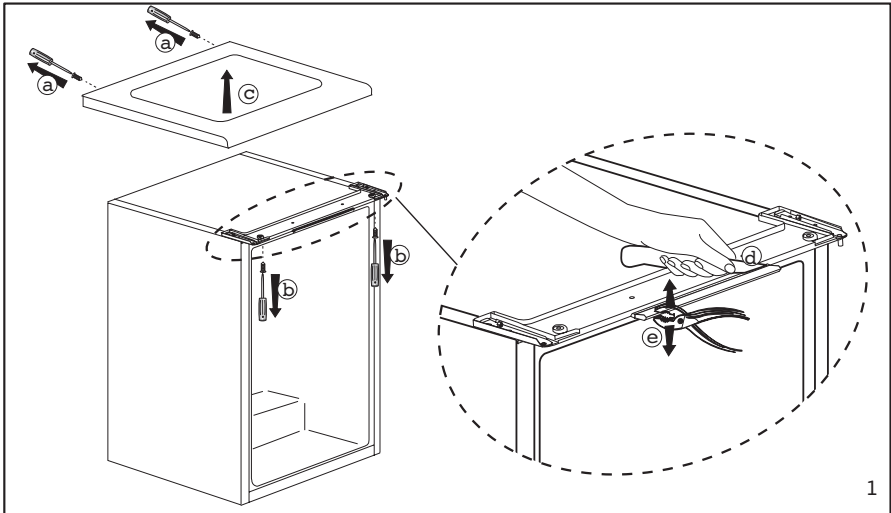

Reversing the doors

Proceed in numerical order

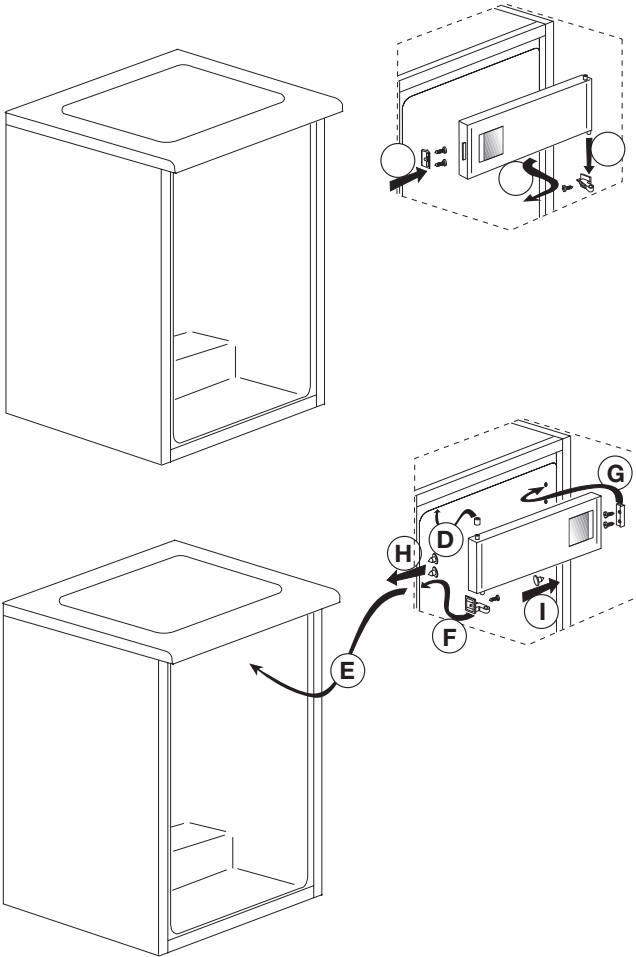

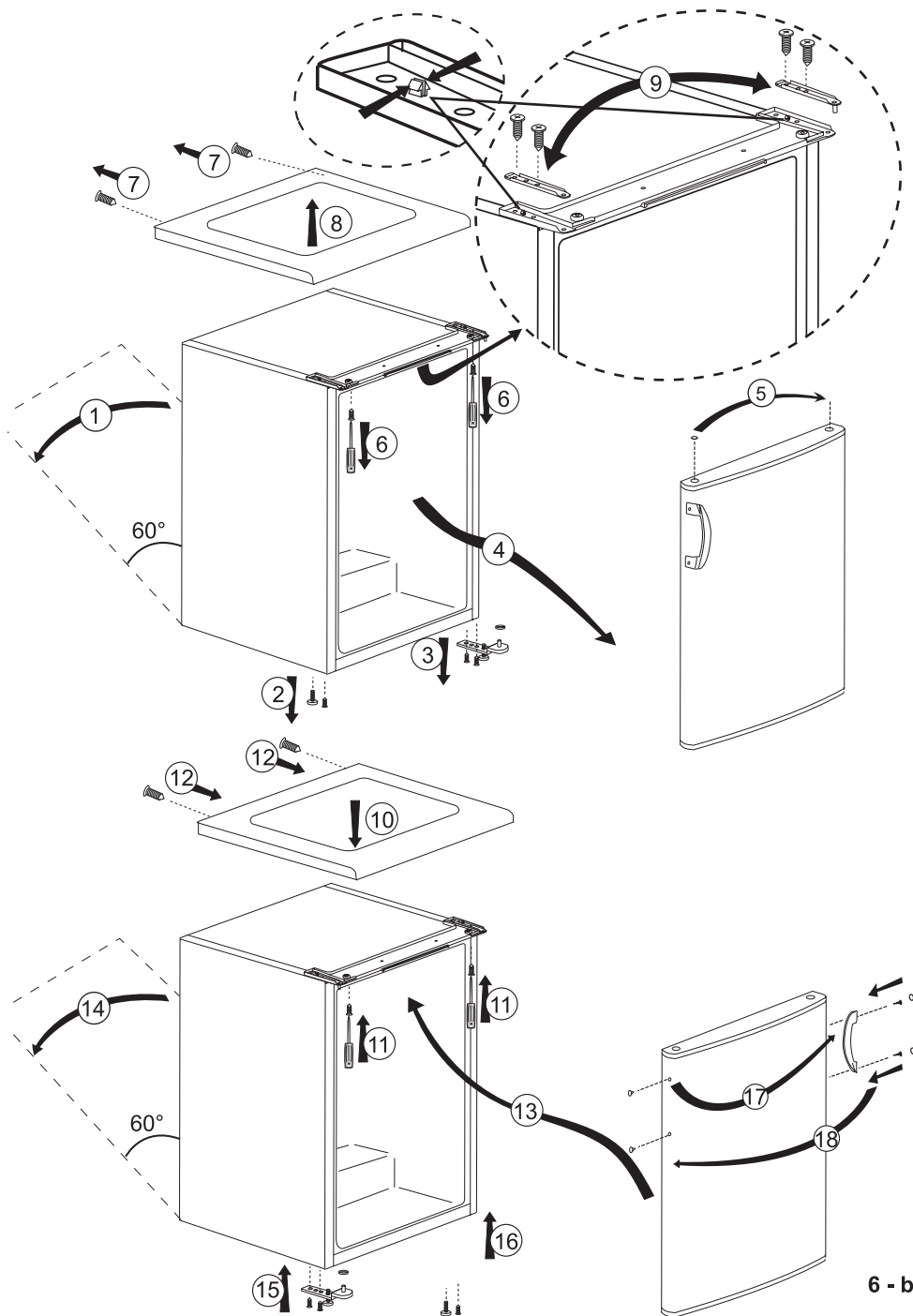

5 Using your cooler/freezer

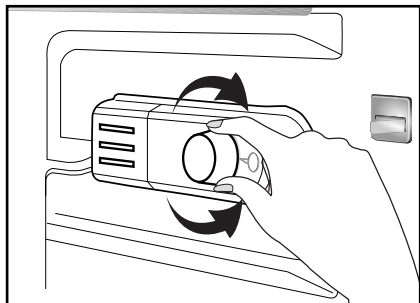

The operating temperature is regulated by the temperature control.

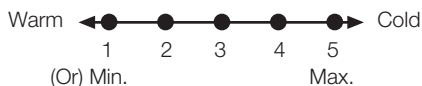

**1 = Lowest cooling setting
(Warmest setting)**

**5 = Highest cooling setting
(Coldest setting)**

(Or)

**Min. = Lowest cooling setting
(Warmest setting)**

**Max. = Highest cooling setting
(Coldest setting)**

The average temperature inside the fridge should be around +4°C.

Recommended thermostat knob position is 4 .It's recommended 1 at cold ambient conditions such as 10 °C.

Please choose the setting according to the desired temperature.

You can stop operation of your appliance by turning the thermostat knob to "0" position.

Please note that there will be different temperatures in the cooling area.

The coldest region is immediately above the vegetable compartment on crisper cover.

The interior temperature also depends on ambient temperature, the frequency with which the door is opened and the amount of food kept inside.

Frequently opening the door causes the interior temperature to rise.

For this reason, it is recommended to close the door again as soon as possible after use.

Freezing food

The freezing compartment is marked with  this symbol.

You can use the appliance for freezing fresh food as well as for storing pre-frozen food.

Please refer to the recommendations given on the packaging of your food.

• Attention

Do not freeze fizzy drinks, as the bottle may burst when the liquid in it is frozen.

Be careful with frozen products such as coloured ice-cubes.

In order to maintain the quality of the food, the freezing must be effected as rapidly as possible.

• Attention

Keep the already deep-frozen food always separated with freshly placed food.

When deep-freezing hot food, the cooling compressor will work until the food is completely frozen. This can temporarily cause excessive cooling of the refrigeration compartment.

If you find the freezer door difficult to open just after you have closed it, don't worry. This is due to the pressure difference which will equalize and allow the door to open normally after a few minutes.

You will hear a vacuum sound just after closing the door. This is quite normal.

Making ice cubes

Fill the ice-cube tray 3/4 full with water and place it in the freezer.

As soon as the water has turned into ice, you can take out the ice cubes.

Never use sharp objects such as knives or forks to remove the ice cubes. There is a risk of injury!

Let the ice cubes slightly thaw instead, or put the bottom of the tray in hot water for a short moment.

Defrosting of the appliance

Excessive build-up of ice will affect the freezing performance of your device.



It is therefore recommended that you defrost your appliance at least twice a year, or whenever the ice build-up exceeds 7 mm.

Defrost your device when there is only little or no food in it.

Take out the deep-frozen food. Wrap the deep-frozen food in several layers of paper, or a blanket, and keep it in a cold place.

Unplug the appliance or switch off the circuit breaker to start the defrosting process.

Take out the accessories (like shelf, drawer etc.) from the appliance and use a suitable container to collect the thawing water.

Use a sponge or a soft cloth to remove thawing water if necessary at the freezing compartment  and frozen food compartment .

Keep the door open during defrosting. For quicker defrosting, place containers with warm water inside the appliance.

Never use electrical devices, defrosting sprays or pointed or sharp-edged objects such as knives or forks to remove the ice.

After the defrosting is done, clean interior walls of the compartment.

Reconnect the appliance to the mains. Place the frozen food into the drawers and slide the drawers into the freezer.

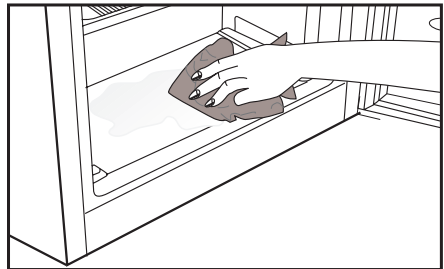

Cooling

Food storage

The fridge compartment is for the short-term storage of fresh food and drinks.

Store milk products in the intended compartment in the cooler/freezer.

Bottles can be stored in the bottle holder or in the bottle shelf of the door.

Raw meat is best kept in a polyethylene bag in the compartment at the very bottom of the cooler/freezer.

Allow hot food and beverages to cool to room temperature prior to placing them in the cooler/freezer.

• Attention

Store concentrated alcohol in a container only standing upright and tightly closed.

• Attention

Do not store explosive substances or containers with flammable propellant gases (canned cream, spray cans etc.) in the appliance.

There is a danger of explosion.

Defrosting of the appliance

The fridge compartment defrosts automatically. The thawing water flows through the drain channel into a collection container at the back of the appliance.

During defrosting, water droplets form at the back wall of the fridge due to the evaporation.

If not all of the drops run down, they may freeze again after defrosting completes. Remove them with a soft cloth dampened with warm water. Do not use hard or sharp objects.

Check the flow of the thawed water from time to time. It may become blocked occasionally. Clean it with a pipe-cleaner or similar implement as shown below.

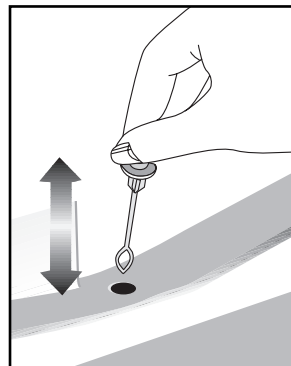

6 Maintenance and cleaning

- ⚠ Never use gasoline, benzene or similar substances for cleaning purposes.
- ⚠ We recommend that you unplug the appliance before cleaning.
- ⚠ Never use any sharp abrasive instrument, soap, household cleaner, detergent and wax polish for cleaning.
- ℹ Use lukewarm water to clean the cabinet of your cooler/freezer and wipe it dry.
- ℹ Use a damp cloth wrung out in a solution of one teaspoon of bicarbonate of soda to one pint of water to clean the interior and wipe it dry.
- ⚠ Make sure that no water enters the lamp housing and other electrical items.
- ⚠ If your cooler/freezer is not going to be used for a long period of time, unplug the power cable, remove all food, clean it and leave the door ajar.
- ℹ Check door seals regularly to ensure they are clean and free from food particles.
- ⚠ To remove door racks, remove all the contents and then simply push the door rack upwards from the base.
- ⚠ Never use cleaning agents or water that contain chlorine to clean the outer surfaces and chromium coated parts of the product. Chlorine causes corrosion on such metal surfaces.

- ⚠ Do not use sharp, abrasive tools, soap, household cleaning agents, detergents, kerosene, fuel oil, varnish etc. to prevent removal and deformation of the prints on the plastic part. Use lukewarm water and a soft cloth for cleaning and then wipe it dry.

Protection of plastic surfaces

- ℹ Do not put the liquid oils or oil-cooked meals in your cooler/freezer in unsealed containers as they damage the plastic surfaces of your cooler/freezer. In case of spilling or smearing oil on the plastic surfaces, clean and rinse the relevant part of the surface at once with warm water.

7 Troubleshooting

Please review this list before calling the service. It will save your time and money. This list includes frequent complaints that are not arising from defective workmanship or material usage. Some of the features described here may not exist in your product.

The cooler/freezer does not operate.

- The plug is not inserted into the socket correctly. >>>Insert the plug into the socket securely.
- The fuse of the socket which your cooler/freezer is connected to or the main fuse have blown out. >>>Check the fuse.

Condensation on the side wall of the fridge compartment (MULTIZONE, COOL CONTROL and FLEXI ZONE).

- Door has been opened frequently. >>>Do not open and close the door of cooler/freezer frequently.
- Ambient is very humid. >>>Do not install your cooler/freezer into highly humid places.
- Food containing liquid is stored in open containers. >>>Do not store food with liquid content in open containers.
- Door of the cooler/freezer is left ajar. >>>Close the door of the cooler/freezer.
- Thermostat is set to a very cold level. >>>Set the thermostat to a suitable level.

Compressor is not running

- Protective thermic of the compressor will blow out during sudden power failures or plug-out plug-ins as the refrigerant pressure in the cooling system of the cooler/freezer has not been balanced yet. The cooler/freezer will start running approximately after 6 minutes. Please call the service if the cooler/freezer does not startup at the end of this period.
- The fridge is in defrost cycle. >>>This is normal for a full-automatically defrosting cooler/freezer. Defrosting cycle occurs periodically.
- The cooler/freezer is not plugged into the socket. >>>Make sure that the plug is fit into the socket.
- Temperature settings are not made correctly. >>>Select the suitable temperature value.
- There is a power outage. >>>Cooler/freezer returns to normal operation when the power restores.

The operation noise increases when the cooler/freezer is running.
<ul style="list-style-type: none"> The operating performance of the cooler/freezer may change due to the changes in the ambient temperature. It is normal and not a fault.
The cooler/freezer is running frequently or for a long time.
<ul style="list-style-type: none"> New product may be wider than the previous one. Larger cooler/freezers operate for a longer period of time. The room temperature may be high. >>>It is normal that the product operates for longer periods in hot ambient. The cooler/freezer might be plugged in recently or might be loaded with food. >>>When the cooler/freezer is plugged in or loaded with food recently, it will take longer for it to attain the set temperature. This is normal. Large amounts of hot food might be put in the cooler/freezer recently. >>>Do not put hot food into the cooler/freezer. Doors might be opened frequently or left ajar for a long time. >>>The warm air that has entered into the cooler/freezer causes the cooler/freezer to run for longer periods. Do not open the doors frequently. Freezer or fridge compartment door might be left ajar. >>>Check if the doors are closed completely. The cooler/freezer is adjusted to a very low temperature. >>>Adjust the cooler/freezer temperature to a warmer degree and wait until the temperature is achieved. Door seal of the fridge or freezer may be soiled, worn out, broken or not properly seated. >>>Clean or replace the seal. Damaged/broken seal causes the cooler/freezer to run for a longer period of time in order to maintain the current temperature.
Freezer temperature is very low while the fridge temperature is sufficient.
<ul style="list-style-type: none"> The freezer temperature is adjusted to a very low value. >>>Adjust the freezer temperature to a warmer degree and check.
Fridge temperature is very low while the freezer temperature is sufficient.
<ul style="list-style-type: none"> The fridge temperature is adjusted to a very low value. >>>Adjust the fridge temperature to a warmer degree and check.
Food kept in the fridge compartment drawers is frozen.
<ul style="list-style-type: none"> The fridge temperature is adjusted to a very high value. >>>Adjust the fridge temperature to a lower value and check.

Temperature in the fridge or freezer is very high.
<ul style="list-style-type: none"> • The fridge temperature is adjusted to a very high value. >>>Fridge compartment temperature setting has an effect on the temperature of the freezer. Change the temperatures of the fridge or freezer and wait until the relevant compartments attain a sufficient temperature. • Doors are opened frequently or left ajar for a long time. >>>Do not open the doors frequently. • Door is ajar. >>>Close the door completely. • The cooler/freezer is plugged in or loaded with food recently. >>>This is normal. When the cooler/freezer is plugged in or loaded with food recently, it will take longer for it to attain the set temperature. • Large amounts of hot food might be put in the cooler/freezer recently. >>>Do not put hot food into the cooler/freezer.
Vibrations or noise.
<ul style="list-style-type: none"> • The floor is not level or stable. >>> If the cooler/freezer rocks when moved slowly, balance it by adjusting its feet. Also make sure that the floor is strong enough to carry the cooler/freezer, and level. • The items put onto the cooler/freezer may cause noise. >>>Remove the items on top of the cooler/freezer.
There are noises coming from the cooler/freezer like liquid flowing, spraying, etc.
<ul style="list-style-type: none"> • Liquid and gas flows occur in accordance with the operating principles of your cooler/freezer. It is normal and not a fault.
Whistle comes from the cooler/freezer.
<ul style="list-style-type: none"> • Fans are used in order to cool the cooler/freezer. It is normal and not a fault.
Condensation on the inner walls of cooler/freezer.
<ul style="list-style-type: none"> • Hot and humid weather increases icing and condensation. It is normal and not a fault. • Doors are opened frequently or left ajar for a long time. >>>Do not open the doors frequently. Close them if they are open. • Door is ajar. >>>Close the door completely.
Humidity occurs on the outside of the cooler/freezer or between the doors.
<ul style="list-style-type: none"> • There might be humidity in the air; this is quite normal in humid weather. When the humidity is less, condensation will disappear.

Bad odour inside the cooler/freezer.

- No regular cleaning is performed. >>>Clean the inside of the cooler/freezer regularly with a sponge, lukewarm water or carbonate dissolved in water.
- Some containers or package materials may cause the smell. >>>Use a different container or different brand packaging material.
- Food is put into the cooler/freezer in uncovered containers. >>>Keep the food in closed containers. Microorganisms spreading out from uncovered containers can cause unpleasant odours.
- Remove the foods that have expired best before dates and spoiled from the cooler/freezer.

The door is not closing.

- Food packages are preventing the door from closing. >>>Replace the packages that are obstructing the door.
- The cooler/freezer is not completely even on the floor. >>>Adjust the feet to balance the cooler/freezer.
- The floor is not level or strong. >>>Make sure that the floor is level and capable to carry the cooler/freezer.

Crispers are stuck.

- The food is touching the ceiling of the drawer. >>>Rearrange food in the drawer.

TECHNICAL DATA

The technical information is situated in the rating plate on the internal side of the appliance and on the energy label.

The QR code on the energy label supplied with the appliance provides a web link to the information related to the performance of the appliance in the EU EPREL database. Keep the energy label for reference together with the user manual and all other documents provided with this appliance.

It is also possible to find the same information in EPREL using the link <https://eprel.ec.europa.eu> and, the model name and product number that you find on the rating plate of the appliance.

INFORMATION FOR TEST INSTITUTES

Installation and preparation of the appliance for any EcoDesign verification shall be compliant with EN 62552. Ventilation requirements, recess dimensions and minimum rear clearances shall be as stated in this User Manual at Chapter 3. Please contact the manufacturer for any other further information, including loading plans.

