



**Freezer**

User manual

**Gefrierkombination**

Betriebsanleitung

**Congelateur**

Guide d'utilisation

**Congelatore**

Istruzioni per l'uso

**Diepvriezer**

Gebruikshandleiding

**Congelador**

Manual de Instrucciones

**Congelador**

Manual de Instruções

**Frys**

Bruksanvisning

**FF18EN2HX**

# Index

<b>BEFORE USING YOUR FREEZER .....</b>	<b>2</b>
<b>SAFETY INSTRUCTIONS .....</b>	<b>2</b>
General Safety Warnings .....	2
During Usage .....	6
Installation warnings .....	7
Before using your freezer .....	8
Information on No-Frost technology .....	8
<b>USAGE INFORMATION.....</b>	<b>9</b>
Display and Control Panel.....	9
Operating your Freezer .....	9
Alarm light .....	9
Freezer Temperature Set Button .....	9
Super Freezer Mode .....	9
Freezer Temperature Settings.....	10
Warnings about temperature adjustments.....	11
Accessories .....	12
Making Ice Cubes.....	12
Ice tray.....	12
<b>PLACING THE FOOD.....</b>	<b>12</b>
<b>CLEANING AND MAINTENANCE .....</b>	<b>16</b>
Defrosting .....	16
Replacing LED lighting .....	16
<b>TRANSPORTATION AND CHANGING OF INSTALLATION POSITION</b>	
<b>17</b>	
Repositioning the door .....	17
<b>BEFORE CALLING AFTER-SALES SERVICE.....</b>	<b>17</b>
<b>THE PARTS OF THE APPLIANCE AND THE COMPARTMENTS ....</b>	<b>20</b>
<b>TECHNICAL DATA .....</b>	<b>21</b>
<b>INFORMATION FOR TEST INSTITUTES.....</b>	<b>21</b>
<b>CUSTOMER CARE AND SERVICE .....</b>	<b>21</b>



**Warning:** Risk of fire / flammable materials

# SAFETY INSTRUCTIONS

## General Safety Warnings

**Read this user manual carefully.**

**⚠ WARNING:** Keep ventilation openings, in the appliance enclosure or in the built-in structure, clear of obstruction.

**⚠ WARNING:** Do not use mechanical devices or other means to accelerate the defrosting process, other than those recommended by the manufacturer.

**⚠ WARNING:** Do not use electrical appliances inside the food storage compartments of the appliance, unless they are of the type recommended by the manufacturer.

**⚠ WARNING:** Do not damage the refrigerant circuit.

**⚠ WARNING:** When positioning the appliance, ensure the supply cord is not trapped or damaged.

**⚠ WARNING:** Do not locate multiple portable socket-outlets or portable power supplies at the rear of the appliance.

**⚠ WARNING:** In order to avoid any hazards resulting from the instability of the appliance, it must be fixed in accordance with the instructions.

**⚠** If your appliance uses R600a as a refrigerant (this information will be provided on the label of the cooler) you should take care during transportation and installation to prevent the cooler elements from being damaged. R600a is an environmentally friendly and natural gas, but it is explosive. In the event of a leak due to damage of the cooler elements, move your fridge away from open flames or heat sources and ventilate the room where the appliance is located for a few minutes.

- While carrying and positioning the fridge, do not damage the cooler gas circuit.

- Do not store explosive substances such as aerosol cans with a flammable propellant in this appliance.
- This appliance is intended to be used in household and domestic applications such as:
  - staff kitchen areas in shops, offices and other working environments.
  - farm houses and by clients in hotels, motels and other residential type environments.
  - bed and breakfast type environments;
  - catering and similar non-retail applications.
- If the socket does not match the refrigerator plug, it must be replaced by the manufacturer, a service agent or similarly qualified persons in order to avoid a hazard.
- A specially grounded plug has been connected to the power cable of your refrigerator. This plug should be used with a specially grounded socket of 16 amperes. If there is no such socket in your house, please have one installed by an authorised electrician.
- This appliance can be used by children aged from 8 years and above and persons with reduced physical, sensory or mental capabilities or lack of experience and knowledge if they have been given supervision or instruction concerning use of the appliance in a safe way and understand the hazards involved. Children shall not play with the appliance. Cleaning and user maintenance shall not be made by children without supervision.
- Children aged from 3 to 8 years are allowed to load and unload refrigerating appliances. Children are not expected to perform cleaning or user maintenance of the appliance, very young children (0-3 years old) are not expected to use appliances, young children (3-8 years old) are not expected to use appliances safely unless continuous supervision is given, older children (8-14 years old) and vulnerable people can

use appliances safely after they have been given appropriate supervision or instruction concerning use of the appliance. Very vulnerable people are not expected to use appliances safely unless continuous supervision is given.

- If the supply cord is damaged, it must be replaced by the manufacturer, an authorised service agent or similar qualified persons, in order to avoid a hazard.
- This appliance is not intended for use at altitudes exceeding 2000 m.

**To avoid contamination of food, please respect the following instructions:**

- Opening the door for long periods can cause a significant increase of the temperature in the compartments of the appliance.
- Clean regularly surfaces that can come in contact with food and accessible drainage systems
- Store raw meat and fish in suitable containers in the refrigerator, so that it is not in contact with or drip onto other food.
- Two-star frozen-food compartments are suitable for storing pre-frozen food, storing or making ice cream and making ice cubes.
- One-, two- and three-star compartments are not suitable for the freezing of fresh food.
- If the refrigerating appliance is left empty for long periods, switch off, defrost, clean, dry, and leave the door open to prevent mould developing within the appliance.

## Old and Out-of-order Fridges

- If your old fridge or freezer has a lock, break or remove the lock before discarding it, because children may get trapped inside it and may cause an accident.
- Old fridges and freezers contain isolation material and refrigerant with CFC. Therefore, take care not to harm environment when you are discarding your old fridges.

## CE Declaration of conformity

We declare that our products meet the applicable European Directives, Decisions and Regulations and the requirements listed in the standards referenced.

## Disposal of your old appliance

The symbol on the product or on its packaging indicates that this product may not be treated as household waste. Instead it shall be handed over to the applicable collection point for the recycling of electrical and electronic equipment. By ensuring this product is disposed of correctly, you will help prevent potential negative consequences for the environment and human health, which could otherwise be caused by inappropriate waste handling of this product. For more detailed information about recycling of this product, please contact your local city office, your household waste disposal service or the shop where you purchased the product.

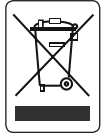

## Packaging and the Environment

Packaging materials protect your machine from damage that may occur during transportation. The packaging materials are environmentally friendly as they are recyclable. The use of recycled material reduces raw material consumption and therefore decreases waste production.



## Notes:

- Please read the instruction manual carefully before installing and using your appliance. We are not responsible for the damage occurred due to misuse.
- Follow all instructions on your appliance and instruction manual, and keep this manual in a safe place to resolve the problems that may occur in the future.
- This appliance is produced to be used in homes and it can only be used in domestic environments and for the specified purposes. It is not suitable for commercial or common use. Such use will cause the guarantee of the appliance to be cancelled and our company will not be responsible for any losses incurred.
- This appliance is produced to be used in houses and it is only suitable for cooling / storing foods. It is not suitable for commercial or common use and/or for storing substances except for food. Our company is not responsible for any losses incurred by inappropriate usage of the appliance.

## During Usage

- Do not connect your freezer to the mains electricity supply using an extension lead.
- Do not use damaged, torn or old plugs.
- Do not pull, bend or damage the cord.
- Do not use plug adapter.
- This appliance is designed for use by adults. Do not allow children to play with the appliance or hang off the door.
- Never touch the power cord/plug with wet hands. This may cause a short circuit or electric shock.
- Do not place glass bottles or cans in your freezer as they will burst when the contents freeze.
- Do not place explosive or flammable material in your freezer.
- When removing ice from the ice-making compartment, do not touch it. Ice may cause frost burns and/or cuts.
- Do not touch frozen goods with wet hands. Do not eat ice-cream or ice cubes immediately after they are removed from the ice-making compartment.
- Do not re-freeze thawed frozen food. This may cause health issues such as food poisoning.



When the door of the freezer is closed, a vacuum seal will form. Wait for 1 minute before reopening it.

This application is optional for easy opening of the door. With this application, a little condensation may occur around this area and you may remove it.

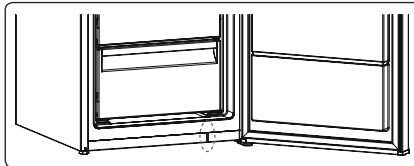

## Installation warnings

Before using your freezer for the first time, please pay attention to the following points:

- The operating voltage for your freezer is 220-240 V at 50Hz.
- The plug must be accessible after installation.
- Your freezer may have an odour when it is operated for the first time. This is normal and the odour will fade when your freezer starts to cool.
- Before connecting your freezer, ensure that the information on the data plate (voltage and connected load) matches that of the mains electricity supply. If in doubt, consult a qualified electrician.
- Insert the plug into a socket with an efficient ground connection. If the socket has no ground contact or the plug does not match, we recommend you consult a qualified electrician for assistance.
- The appliance must be connected with a properly installed fused socket. The power supply (AC) and voltage at the operating point must match with the details on the name plate of the appliance (the name plate is located on the inside left of the appliance).
- We do not accept responsibility for any damages that occur due to ungrounded usage.
- Place your freezer where it will not be exposed to direct sunlight.
- Your freezer must never be used outdoors or exposed to rain.
- Your appliance must be at least 50 cm away from stoves, gas ovens and heater cores, and at least 5 cm away from electrical ovens.
- If your freezer is placed next to a deep freezer, there must be at least 2 cm between them to prevent humidity forming on the outer surface.
- Do not cover the body or top of freezer with lace. This will affect the performance of your freezer.
- Clearance of at least 150 mm is required at the top of your appliance. Do not place anything on top of your appliance.
- Do not place heavy items on the appliance.
- Clean the appliance thoroughly before use (see Cleaning and Maintenance).
- Before using your freezer, wipe all parts with a solution of warm water and a teaspoon of sodium bicarbonate. Then, rinse with clean water and dry. Return all parts to the freezer after cleaning.
- Use the adjustable front legs to make sure your appliance is level and stable. You can adjust the legs by turning them in either direction. This must be done before placing food in the appliance.
- Install the two plastic distance guides (the parts on the black vanes -condenser- at the rear) by turning it 90° (as shown in the figure) to prevent the condenser from touching the wall.
- The distance between the appliance and back wall must be a maximum of 75 mm.

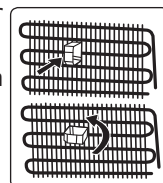



## Before using your freezer

- When using your freezer for the first time, or after transportation, keep it in an upright position for at least 3 hours before plugging into the mains. This allows efficient operation and prevents damage to the compressor.
- Your freezer may have a smell when it is operated for the first time. This is normal and the smell will fade away when your freezer starts to cool.



## Information on No-Frost technology

No-frost freezers differ from other static freezers in their operating principle.

In normal freezers, the humidity entering the freezer due to opening the door and the humidity inherent in the food causes freezing in the freezer compartment. To defrost the frost and ice in the freezer compartment, you are periodically required to turn off the freezer, place the food that needs to be kept frozen in a separately cooled container and remove the ice gathered in the freezer compartment.

The situation is completely different in no-frost freezers. Dry and cold air is blown into the freezer compartment homogeneously and evenly from several points via a blower fan. Cold air dispersed homogeneously and evenly between the shelves cools all of your food equally and uniformly, thus preventing humidity and freezing.

Therefore your no-frost freezer allows you ease of use, in addition to its huge capacity and stylish appearance.

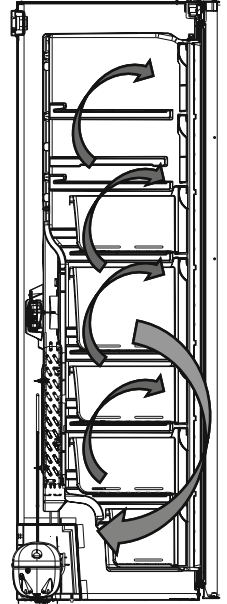

# USAGE INFORMATION

## Display and Control Panel

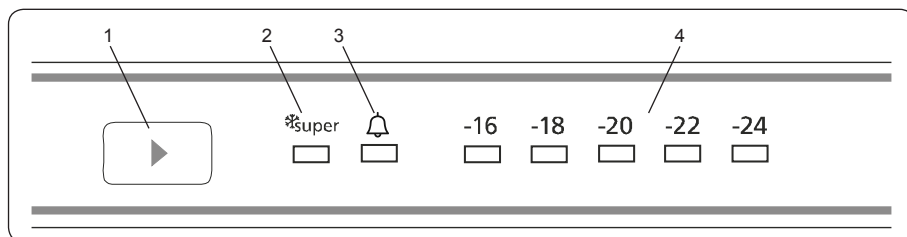

### Lighting (If available)

When the product is plugged in for the first time, the interior lights may turn on 1 minute late due to opening tests.

### Using the Control Panel

1. Freezer temperature set button
2. Super freeze symbol (Super freeze LED)
3. Alarm symbol (Alarm LED)
4. Freezer adjusted temperature indicator

## Operating your Freezer

### Alarm light

In case of a problem within the freezer, the alarm led will release red light.

### Freezer Temperature Set Button

This button allows setting temperature of the freezer. In order to set values for freezer partition, press this button. Use this button also to activate super freeze mode.

### Super Freezer Mode

#### When Would It Be Used?

- To freeze huge quantities of food.
- To freeze fast food.
- To freeze food quickly.
- To store seasonal food for a long time.

#### How To Use?

- Press temperature set button until super freezing light comes on.
- Super freezing led will light during this mode.
- Maximum amount of fresh food (in kilograms) to be frozen within 24 hours is shown on the appliance label.
- For optimal appliance performance in maximum freezer capacity, set the appliance to active super freeze mode 24 hours before you put the fresh food into the freezer.

#### During This Mode:

If you press temperature set button, the mode will be cancelled and the setting will be restored from -16.

## Freezer Temperature Settings

- The initial temperature of the setting display is -18 °C.
- Press freezer setting button once.
- Every time you press the button, the setting temperature will decrease. (-16 °C, -18 °C, -20 °C,.. super freezing)
- If you press freezer setting button until super freezer symbol is displayed on freezer.
- Settings display and you do not press any button within the following 3 seconds, super freezing will blink.
- If you keep on pressing, it will restart from last value.

## Recommended Temperature Values for Freezer

When to adjust	Inner Temperature
For minimum freezing capacity	-16 °C, -18 °C
In normal usage	-18 °C, -20 °C, -22 °C
For maximum freezing capacity	-24 °C

## Warnings about temperature adjustments

- It is not recommended that you operate your fridge in environments colder than 10°C in terms of its efficiency.
- Temperature adjustments should be made according to the frequency of door openings and the quantity of food kept inside the fridge.
- Do not pass to another adjustment before completing an adjustment.
- Your fridge should be operated up to 24 hours according to the ambient temperature without interruption after being plugged in to be completely cooled. Do not open doors of your fridge frequently and do not place much food inside it in this period.
- A 5 minute delaying function is applied to prevent damage to the compressor of your fridge, when you take the plug off and then plug it on again to operate it or when an energy breakdown occurs. Your fridge will start to operate normally after 5 minutes.
- Your fridge is designed to operate in the ambient temperature intervals stated in the standards, according to the climate class stated in the information label. We do not recommend operating your fridge out of stated temperatures value limits in terms of cooling effectiveness.
- This appliance is designed for use at an ambient temperature within the 10°C - 43°C range.

### Climate class and meaning:

**T (tropical):** This refrigerating appliance is intended to be used at ambient temperatures ranging from 16 °C to 43 °C.

**ST (subtropical):** This refrigerating appliance is intended to be used at ambient temperatures ranging from 16 °C to 38 °C.

**N (temperate):** This refrigerating appliance is intended to be used at ambient temperatures ranging from 16 °C to 32 °C.

**SN (extended temperate):** This refrigerating appliance is intended to be used at ambient temperatures ranging from 10 °C to 32 °C.

### Important installation instructions

This appliance is designed to work in difficult climate conditions (up to 43 degrees C or 110 degrees F) and is powered with 'Freezer Shield' technology which ensures that the frozen food in the freezer will not defrost even if the ambient temperature falls as low as -15 °C. So you may then install your appliance in an unheated room without having to worry about frozen food in the freezer being spoiled. When the ambient temperature returns to normal, you may continue using the appliance as usual.

## Accessories

### Making Ice Cubes (In some models)

- Pull the lever towards you and remove the ice maker tray
- Fill with water to the level of line
- Hold the left end of the lever and set the ice-tray on the icebox
- When ice cubes are formed, twist the lever to drop ice cubes into the ice box.

***Do not fill the icebox with water in order to make ice. It can break.***

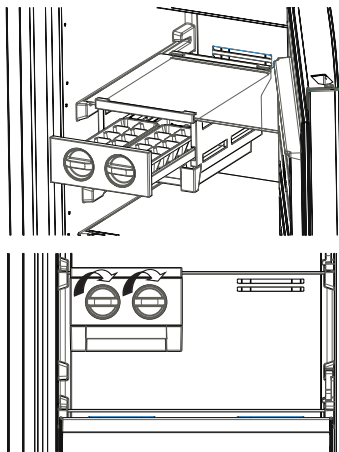

### Ice tray (In some models)

- Fill the ice tray with water and place in freezer compartment.
- After the water completely turned into ice, you can twist the tray as shown below to get the ice cube.

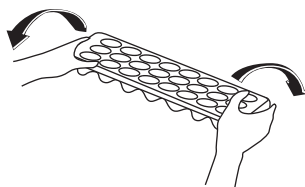
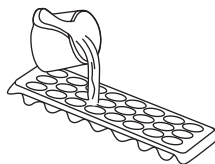

## PLACING THE FOOD

- The freezer compartment is used for freezing fresh food, for storing frozen foods for the period of time indicated on packaging and for making ice cubes..
- Do not put fresh and warm food next to frozen food as it can thaw the frozen food.
- While freezing fresh foods (i.e. meat, fish and mincemeat) divide them in portions you will use in a single serving.
- For storing frozen foods, the instructions shown on frozen food packages should always be followed carefully. If no information is provided, food should not be stored for more than 3 months from the purchased date.
- **Maximum load:** if you want to store large quantities of food and use the maximum net capacity of the freezer, you can remove all the sliding drawers but you should keep the upper shelf flaps. Thanks to this, it is possible to store bulky items directly on the shelves.
- When buying frozen food ensure that these have been frozen at suitable temperatures and that the packing is intact.
- Frozen food should be transported in appropriate containers to maintain the quality of the food and should be returned to the freezing surfaces of the unit in the shortest

possible time.

- If a package of frozen food shows signs of humidity and abnormal swelling it is probable that it has been previously stored at an unsuitable temperature and that the contents have deteriorated..
- The storage life of frozen foods depends on the room temperature, thermostat setting, how often the door is opened, the type of food and the length of time required to transport the product from the shop to your home. Always follow the instructions printed on the packaging and never exceed the maximum storage life indicated.

#### **If you would use maximum freezing capacity of your freezer:**

- While freezing fresh foods, the maximum amount of fresh food (in kg) that can be frozen in 24 hours is indicated on the appliance label. (your refrigerator has the capacity to freeze 25 kg at 25°C ambient)
- For optimum appliance performance to reach maximum freezing capacity, activate Super Freeze (SF) mode 24 hours before placing fresh food into the freezer.
- After placing fresh food into the freezer, 24 hours is generally sufficient for freezing. "Super Freeze" mode will be deactivated automatically in 2-3 days to save energy.

#### **If you would freeze a small amount (up to 3 kg) in your freezer:**

- Place your food without touching already frozen food and activate "Fast Freezing" mode. You can put your food next to other frozen food after it is completely frozen (after minimum 24 hours).
- Do not re-freeze frozen food after it has thawed. This may cause health issues, such as food poisoning.
- Allow hot food to completely cool down before placing it in the freezer.
- When buying frozen food ensure that these have been frozen at suitable temperatures and that the packing is intact.

#### **A+ models**

If there is a power cut or malfunction, do not open the door. This will help maintain the temperature inside the freezer, ensuring that foods are conserved for about 15 hours at 25°C. Do not re-freeze food that is defrosting or that has already been defrosted. These foods must be cooked and eaten.

<b>Dairy Products</b>	<b>Preparation</b>	<b>Maximum Storing time (months)</b>	<b>Storing Conditions</b>
Packet (Homogenize) Milk	In its own packet	2 - 3	Pure Milk – In its own packet
Cheese-excluding white cheese	In slices	6 - 8	Original package may be used for short storing period. It should be wrapped in foil for longer periods.
Butter, margarine	In its package	6	

	Maximum Storing time (months)	Thawing time in room temperature (hours)	Thawing time in oven (minutes)
<b>Bread</b>	4 - 6	2 - 3	4-5 (220-225 °C)
<b>Biscuits</b>	3 - 6	1 - 1,5	5-8 (190-200 °C)
<b>Pastry</b>	1 - 3	2 - 3	5-10 (200-225 °C)
<b>Pie</b>	1 - 1,5	3 - 4	5-8 (190-200 °C)
<b>Phyllo dough</b>	2 - 3	1 - 1,5	5-8 (190-200 °C)
<b>Pizza</b>	2 - 3	2 - 4	15-20 (200 °C)

Meat and fish	Preparation	Maximum Storing time (month)
<b>Steak</b>	Wrapping in a foil	6 - 8
<b>Lamb meat</b>	Wrapping in a foil	6 - 8
<b>Veal roast</b>	Wrapping in a foil	6 - 8
<b>Veal cubes</b>	In small pieces	6 - 8
<b>Lamb cubes</b>	In pieces	4 - 8
<b>Minced meat</b>	In packages without using spices	1 - 3
<b>Giblets (pieces)</b>	In pieces	1 - 3
<b>Bologna sausage/salami</b>	Should be packaged even if it has membrane	
<b>Chicken and turkey</b>	Wrapping in a foil	4 - 6
<b>Goose and Duck</b>	Wrapping in a foil	4 - 6
<b>Deer, Rabbit, Wild Boar</b>	In 2.5 kg portions and as fillets	6 - 8
<b>Freshwater fishes (Salmon, Carp, Crane, Siluroidea)</b>	After cleaning the bowels and scales of the fish, wash and dry it; and if necessary, cut off the tail and head.	2
<b>Lean fish; bass, turbot, flounder</b>		4
<b>Fatty fishes (Tunny, Mackarel, bluefish, anchovy)</b>		2 - 4
<b>Shellfish</b>	Cleaned and in bags	4 - 6
<b>Caviar</b>	In its package, aluminium or plastic container	2 - 3
<b>Snails</b>	In salty water, aluminum or plastic container	3



**Note:** Frozen meat should be cooked as fresh meat after being thawed. If the meat is not cooked after being thawed, it must not be re-frozen.

<b>Vegetables and Fruits</b>	<b>Preparation</b>	<b>Maximum Storing time (months)</b>
<b>String beans and beans</b>	Wash and cut into small pieces and boil in water	10 - 13
<b>Beans</b>	Hull and wash and boil in water	12
<b>Cabbage</b>	Cleaned and boil in water	6 - 8
<b>Carrot</b>	Clean and cut to slices and boil in water	12
<b>Pepper</b>	Cut the stem, cut into two pieces, remove the core and boil in water	8 - 10
<b>Spinach</b>	Washed and boil in water	6 - 9
<b>Cauliflower</b>	Take the leaves apart, cut the heart into pieces, and leave it in water with a little lemon juice for a while	10 - 12
<b>Eggplant</b>	Cut to pieces of 2cm after washing	10 - 12
<b>Corn</b>	Clean and pack with its stem or as sweet corn	12
<b>Apple and pear</b>	Peel and slice	8 - 10
<b>Apricot and Peach</b>	Cut into two pieces and remove the stone	4 - 6
<b>Strawberry and Blackberry</b>	Wash and hull	8 - 12
<b>Cooked fruits</b>	Adding 10 % of sugar in the container	12
<b>Plum, cherry, sourberry</b>	Wash and hull the stems	8 - 12



# CLEANING AND MAINTENANCE

- **Disconnect the unit from the power supply before cleaning.**



- Do not clean the appliance by pouring water.



- Make sure that no water enters the lamp housing and other electrical components.
- The freezer should be cleaned periodically using a solution of bicarbonate of soda and lukewarm water.

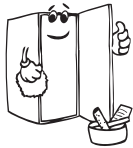
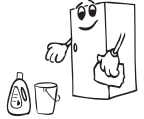

- Clean the accessories separately with soap and water. Do not clean them in the dishwasher.

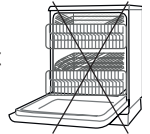

- Do not use abrasive products, detergents or soaps. After washing, rinse with clean water and dry carefully. When you have finished cleaning, reconnect the plug to the mains supply with dry hands.

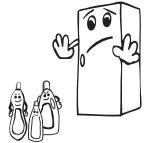

- Clean the condenser with a broom at least twice a year. This will help you to save on energy costs and increase productivity.

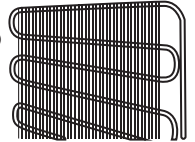

## THE POWER SUPPLY MUST BE DISCONNECTED.

### Defrosting

Your freezer has fully automatic defrosting. The water formed as a result of defrosting passes through the water collection spout, flows into the vaporisation container below the condenser and evaporates there.

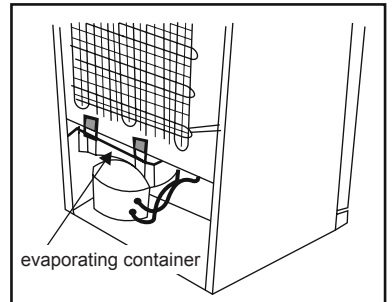

### Replacing LED lighting

If your refrigerator has LED lighting, contact the help desk as this should be changed by authorized personnel only.

## TRANSPORTATION AND CHANGING OF INSTALLATION POSITION

- The original packages and foamed polystyrene (PS) can be retained if required.
- During transportation, the appliance should be secured with a wide string or a strong rope. The instructions written on the corrugated box must be followed while transporting.
- Before transporting or changing the installation position, all the moving objects (ie, drawer, Ice trays, ...) should be taken out or fixed with bands in order to prevent them from getting damaged.

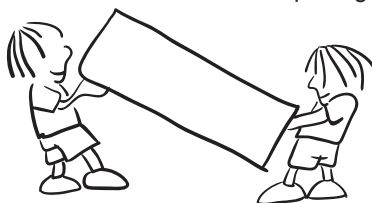

**Carry your freezer in the upright position.**

### Repositioning the door

- It is not possible to change the opening direction of your freezer door, if the door handle on your freezer are installed from the front surface of the door.
- It is possible to change the opening direction of the door on models without any handle.
- If the door opening direction of your freezer may be changed, you should contact the nearest authorised service to have the opening direction changed.

## BEFORE CALLING AFTER-SALES SERVICE

### Errors

Your freezer will warn you if the temperatures for the freezer is at improper levels or if a problem occurs with the appliance. In case of a problem within the freezer, the alarm led will release red light.

Alarm indicator LED is turning on	MEANING	WHY	WHAT TO DO
	"Failure" Warning	There is/are some part(s) out of order or there is a failure in the cooling process. The product is plugged for the first time or a long-time power interruption for 1 hour.	Check the door is open or not and check if the product working 1 hour. If the door is not open and the product had worked 1 hour, call service for assistance as soon as possible.

If you are experiencing a problem with your freezer, please check the following before contacting the after-sales service.

### Your freezer is not operating

#### Check if:

- There is power
- The plug is correctly placed in the socket
- The plug fuse or the mains fuse has blown
- The socket is faulty. Examine this by plugging your freezer into a working socket.

### What to do if your appliance performs poorly;

#### Check that;

- You have not overloaded the appliance,
- The freezer temperature set to -16,

- The doors are closed perfectly,
- There is no dust on the condenser,
- There is enough place at the rear and side walls.

### **Your freezer is operating noisily**

#### **Normal noises**

#### **Cracking (ice cracking) noise occurs:**

- During automatic defrosting
- When the appliance is cooled or warmed (due to expansion of appliance material).

**Short cracking noise occurs:** When the thermostat switches the compressor on/off.

**Motor noise:** Indicates the compressor is operating normally. The compressor may cause more noise for a short time when it is first activated.

**Bubbling noise and splash occurs:** Due to the flow of the refrigerant in the tubes of the system.

**Water flowing noise occurs:** Due to water flowing to the evaporation container. This noise is normal during defrosting.

**Air blowing noise occurs:** In No-Frost freezers during normal operation of the system due to the circulation of air.

### **The edges of the freezer in contact with the door joint are warm**

Especially during summer (warm seasons), the surfaces in contact with the door joint may become warmer during the operation of the compressor, this is normal.

### **The door does not open or close properly**

#### **Check if:**

- There is food or packaging preventing the door from closing
- The door joints are broken or torn
- Your freezer is on a level surface.

### **Important Notes:**

- In the case of a power failure, or if the appliance is unplugged and plugged in again, the gas in the cooling system of your freezer will destabilise, causing the compressor protective thermal element to open. Your freezer will start to operate normally after 5 minutes.
- If the appliance will not be used for a long period of time (such as during holidays), disconnect the plug. Defrost and clean the freezer, leaving the door open to prevent the formation of mildew and odour.
- If the problem persists after you have followed all the instructions above, please consult the nearest Authorised Service Centre.
- This appliance is designed for domestic use and for the stated purposes only. It is not suitable for commercial or common use. If the consumer uses the appliance in a way that does not comply with these instructions, we emphasise that the manufacturer and the dealer will not be responsible for any repair or failure within the guarantee period.

## 1 TIPS FOR SAVING ENERGY

1. Install the appliance in a cool, well-ventilated room, but not in direct sunlight and not near a heat source (such as a radiator or oven) otherwise an insulating plate should be used.
2. Allow warm food and drinks to cool before placing them inside the appliance.
3. Drinks or other liquids should be covered when inside the appliance. If left uncovered, the humidity inside the appliance will increase, therefore the appliance uses more energy. Keeping drinks and other liquids covered helps preserve their smell and taste.
4. Avoid keeping the doors open for long periods and opening the doors too frequently as warm air will enter the appliance and cause the compressor to switch on unnecessarily often.
5. The door gasket must be clean and pliable. In case of wear, if your gasket is detachable, replace the gasket. If not detachable, you have to replace the door.

# THE PARTS OF THE APPLIANCE AND THE COMPARTMENTS

This appliance is not intended to be used as a built-in appliance.

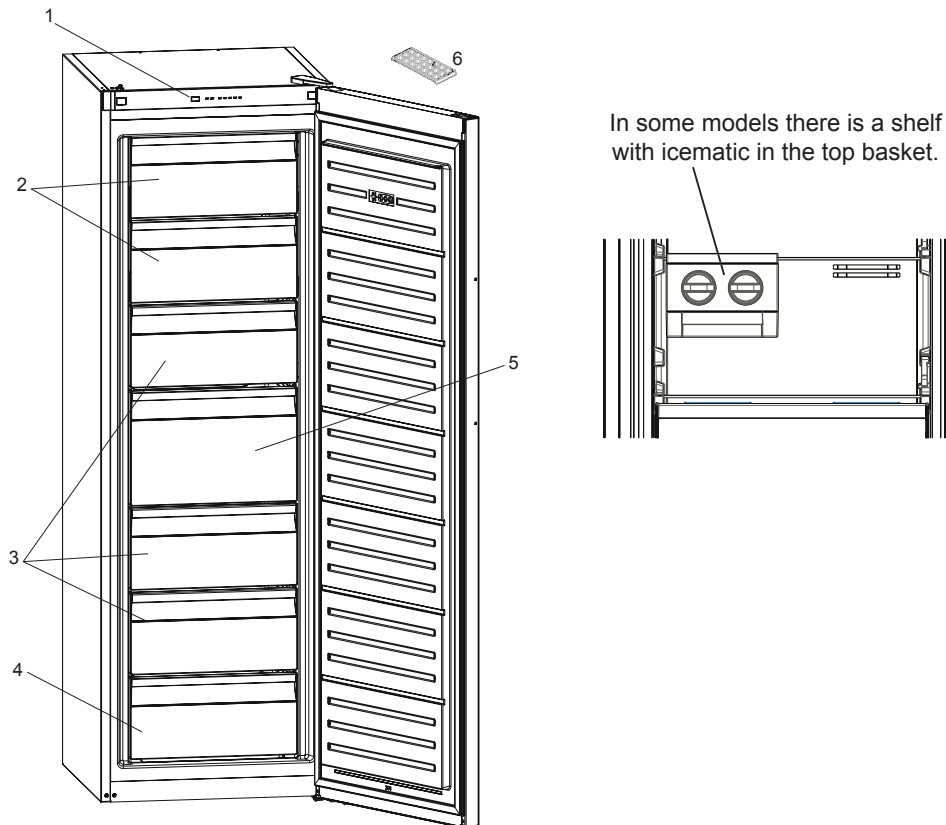

This presentation is only for information about the parts of the appliance.  
Parts may vary according to the appliance model.

- 1. Control panel
- 2. Freezer flaps
- 3. Freezer drawers

- 4. Freezer bottom drawer
- 5. Freezer big drawer
- 6. Ice tray (*In some models*)

\* In some models

## General notes:

**Freezer Compartment (Freezer):** Most Efficient use of energy is ensured in the configuration with the drawers and bins are on stock position.

## TECHNICAL DATA

The technical information is situated in the rating plate on the internal side of the appliance and on the energy label.

The QR code on the energy label supplied with the appliance provides a web link to the information related to the performance of the appliance in the EU EPREL database.

Keep the energy label for reference together with the user manual and all other documents provided with this appliance.

It is also possible to find the same information in EPREL using the link <https://eprel.ec.europa.eu> and the model name and product number that you find on the rating plate of the appliance. See the link [www.theenergylabel.eu](http://www.theenergylabel.eu) for detailed information about the energy label.

## INFORMATION FOR TEST INSTITUTES

Appliance for any EcoDesign verification shall be compliant with EN 62552.

Ventilation requirements, recess dimensions and minimum rear clearances shall be as stated in this User Manual at. Please contact the manufacturer for any other further information, including loading plans.

## CUSTOMER CARE AND SERVICE

Always use original spare parts.

When contacting our Authorised Service Centre, ensure that you have the following data available: Model, Serial Number and Service Index.

The information can be found on the rating plate. Subject to change without notice.

The original spare parts for some specific components are available for a minimum of 7 or 10 years, based on the type of component, from the placing on the market of the last unit of the model.

**Visit our website to:**

**Get User manuals:** <https://www.smeg.com/info/download-manuals>

**Get Service information:** <https://www.smeg.com/services/customer-service>