

INSTRUCTION MANUAL

DRIP COFFEE MACHINE

دليل التعليمات

ماكينة تحضير القهوة بالتنقيط

EN
AR



Important information for the user معلومات هامة للمستخدم



Recommendations / تحذيرات



Description / الوصف



Use / الإستعمال



Cleaning and care / التنظيف و الصيانة



Safety instructions / تحذير للسلامة



Information / معلومات



Advice / اقتراحات

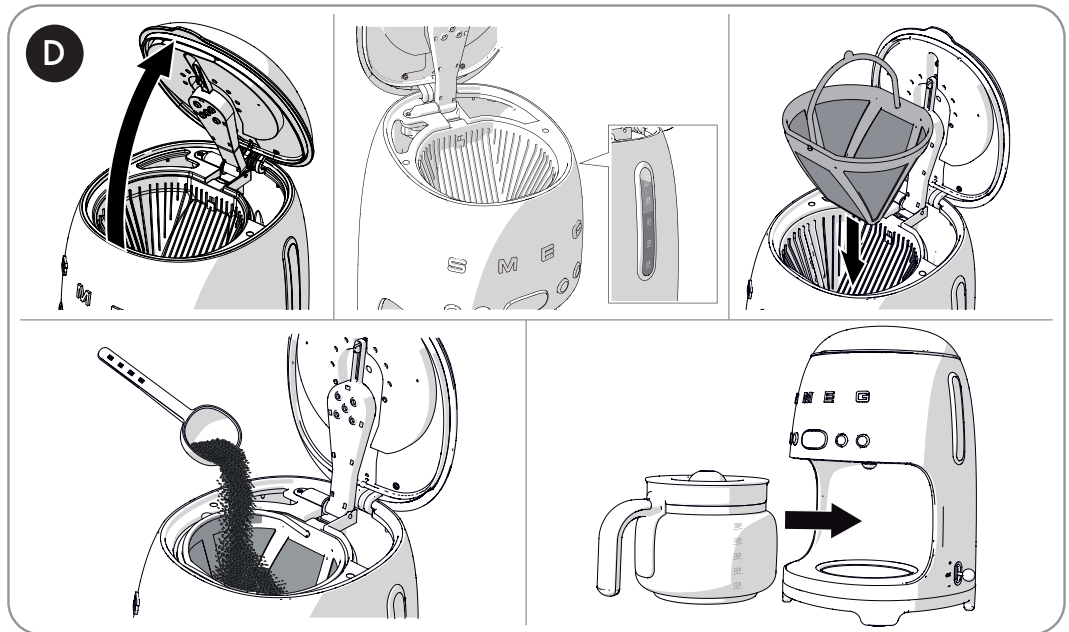
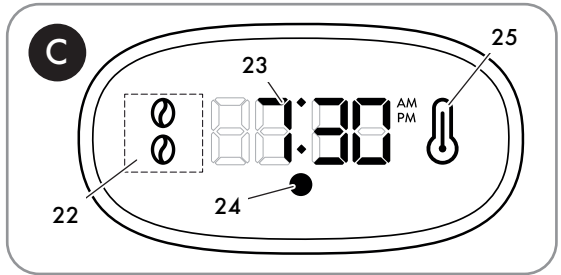
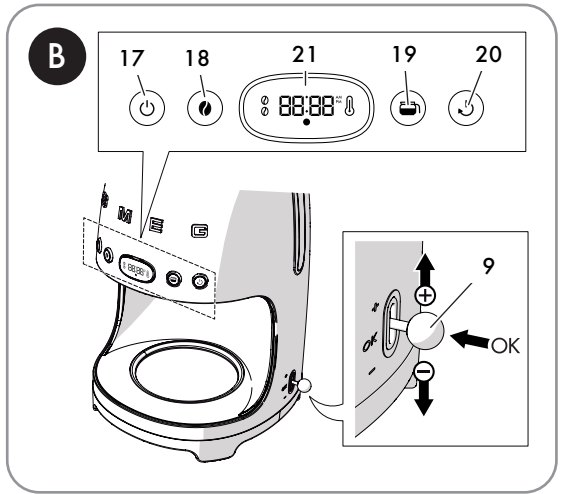
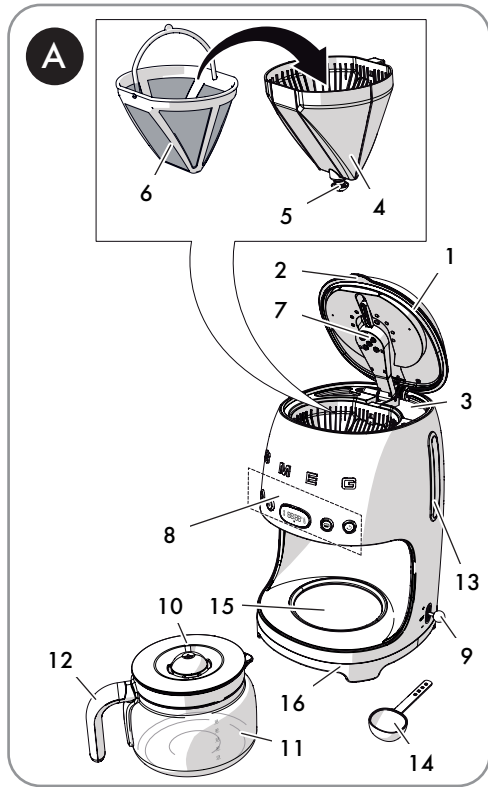

Dear Customer, Thank you for purchasing one of our appliances. Our products are unique because they combine iconic style with innovative technical solutions. They match perfectly with other products in our range and work equally well as a standalone design objects in your kitchen. We hope you enjoy using your new appliance! Best regards.

تحفظ جهة التصنيع بحقها في إجراء أية تغييرات تراها ضرورية لتحسين منتجاتها دون إخطار مسبق. لذا، تعتبر الرسوم التوضيحية والأوصاف الواردة في هذا الدليل غير ملزمة ولكنها إرشادية فقط.



1 Safety

1.1 Essential safety information

Follow all the safety instructions in order to use the appliance safely:

- Read this user manual carefully before using the appliance.
- Never submerge the appliance in water.
- Failure to observe these warnings can lead to fire, electrocution or even death.
- If the plug or power cable becomes damaged, have them replaced only by an authorised service centre in order to avoid risks.
- Switch off the appliance immediately after use.
- Always disconnect the appliance from the power socket before assembling and disassembling components and before cleaning.
- Unplug the coffee machine before cleaning it and if you notice any fault.
- Let the appliance cool down before cleaning.
- Do not use the appliance if there is no water in the tank. Use cold, preferably filtered, water. Do not use other liquids.
- Make sure that the lid is firmly closed.
- Danger of burns! Do not open the lid while the coffee is being brewed.
- Danger of burns! Do not touch hot surfaces with your hands: use the handles and buttons.
- Danger of burns! The keep warm plate under the jug remains hot for a few minutes after the coffee has been brewed. Do not touch it.
- Do not use the appliance or parts of it with parts or accessories made by other manufacturers.
- Only use original spare parts. The use of spare parts not approved by the manufacturer could lead to fires, electric shocks or personal injury.
- Only place the appliance on level and dry surfaces.
- Avoid getting the appliance wet and do not spray liquids onto it. In the event of contact with liquid, immediately switch off the power at the socket or main breaker and dry the appliance thoroughly: Electric shock hazard!
- Do not position the appliance near sinks or taps.
- Do not use harsh detergents or sharp objects to clean the drip coffee machine.
- Do not make any modifications to the appliance.
- Never try to put out a fire or flames with water: turn off the appliance and remove the plug from the socket, and smother the flames with a fire blanket or other appropriate cover.
- Prevent the power cord from coming into contact with sharp edges.
- Never position the appliance above or near gas or electric hob burners when they are hot or in use, inside an oven or near other heat sources.
- Before pouring the coffee, make sure that the lid has been inserted firmly into the top of the jug.
- Do not place the jug on a hob, in an oven or in a microwave oven.
- Do not place the hot jug on cold or wet surfaces.



Instructions

- Do not use the jug if it is damaged or the handle is loose.
- Fill the water tank before putting the plug to the electrical outlet.
- Do not install the appliance in environments in which the temperature is 0°C or less.
- This appliance can be used by children aged 8 and over if they are supervised or if they have been given instructions about how to use the appliance safely and they understand the hazards involved. Cleaning and maintenance of the appliance must not be carried out by children unless they are over 8 years of age and supervised. Keep the appliance and its cord out of reach of children under the age of 8 years.
- The appliances may be used by people with reduced physical, sensory or mental capabilities or who lack experience and knowledge if they are supervised or if they have been given instructions about how to use the appliance safely and they understand the hazards involved.
- Children must not be allowed to play with the appliance.
- This manual contains instructions for cleaning, maintenance and recommendations from the manufacturer to the customer. Any other intervention should be carried out by an authorised service centre.
- Instructions for cleaning the appliance can be found in section “4 Cleaning and maintenance”.

1.2 Connecting the appliance

Make sure that the mains voltage and the frequency correspond to those indicated on the data plate on the bottom of the appliance.

If the plug of the appliance is not compatible with the socket, contact the Technical Assistance service for replacement.

- Plug into an earthed 3-pin socket.
- Do not use an adapter.
- Do not use an extension cord.



1.3 Intended use

- The appliance can be used to prepare drip coffee. Every other use is considered improper. Do not use the appliance for anything other than its intended use.
- Do not use the appliance outdoors.
- The appliance must not be used inside a piece of furniture.
- **CAUTION:** Do not use the appliance if the surface is cracked.
- The appliance is intended for household use and similar applications such as:
 - in kitchen areas provided for personnel in shops, offices and other work environments;
 - in bed and breakfast and farm accommodation;
 - by guests in hotels, motels and residential environments.
- Any other use, for example in restaurants, bars and coffee shops is considered improper.

1.4 Manufacturer liability

The manufacturer shall not be liable for injuries or property damage caused by:

- Use of the appliance other than that specified
- Failure to read the user manual
- Tampering with any part of the appliance
- Use of non-original spare parts
- Failure to observe the safety instructions



Please keep these instructions carefully. If the appliance is passed on to others, they should also be given this instructions booklet.

These instructions can be downloaded from the Smeg website "www.smeg.com".

1.5 Disposal



Devices marked with this symbol are subject to European Directive 2012/19/EU

- All waste electrical and electronic appliances must be disposed of separately from domestic waste and taken to authorised waste disposal facilities. Disposing of the used appliance correctly, will help to safeguard the environment and human health. For further information regarding the disposal of used appliances, please contact your local authorities, the waste disposal department or the shop where the appliance was purchased.



Description

2 Appliance description (Fig. A)

- 1) Lid
- 2) Tab
- 3) Water tank (1.4 litres)
- 4) Filter holder
- 5) Anti-drip valve
- 6) Permanent filter
- 7) Boiler outlet
- 8) Control panel and display
- 9) Time / timer setting lever
- 10) Jug lid
- 11) Jug (10 cups)
- 12) Jug handle
- 13) Water tank level indicator (max. 1.4 litres)
- 14) Scoop
- 15) Keep Warm plate
- 16) Base and non-slip feet

2.1 Identification plate

The identification plate bears the technical data, serial number and brand name of the appliance.

Do not remove the identification plate for any reason.

2.2 Before first use

- Carefully unpack the appliance, remove all packaging materials and remove the label from the display.
- Thoroughly wash and dry the components of the drip coffee machine (see section "4 Cleaning and maintenance").



Before use, make sure that all components are intact and that there are no cracks

2.3 Description of controls (Fig. B)

ON/OFF button (17)

Dispense button. When the button is pressed, the machine starts brewing coffee according to the pre-set functions. You can stop brewing coffee at any time by pressing the button again.

Aroma button (18)

Pressing the button allows you to select between Delicate and Intense Aroma. The intensity selection will be shown on the display: one bean for Delicate Aroma, or two beans for Intense Aroma.



The aroma setting is maintained for subsequent brewing cycles.

4-Cup button (19)

This button allows you to brew a small amount of coffee, corresponding to approximately 4 cups.

To activate the 4-cup function, see section "4 cups function".

Autostart button (20)

This button allows the appliance to be programmed to switch on automatically to prepare drip coffee at a time selected by the user.

To set, activate and use this function, see the section "Autostart function".

Time / timer setting lever (9)

The lever at the side allows you to select and set the machine settings such as:

- setting the time



- selecting and setting the water hardness
- setting the sounds

For more details on the settings, see the section "Machine settings".

2.4 Display Description (Fig. C)

The display (21) allows the user to view the functions set on the machine:

	Icon	Meaning
22		Delicate Aroma
		Intense Aroma
23		Time
		Red:
24		Descaling recommended
25		Keep Warm



The **KEEP WARM** mode is activated automatically after the coffee has been brewed and keeps the warming plate on for 60 minutes. In this way, the coffee will remain hot for 60 minutes after it has been brewed.

3 Use (Fig. D)

- Make sure that the plug is properly inserted into the power socket.



When connecting the machine to the power socket, you are prompted to set the time (see section "Machine settings")

- Lift the lid (1) by pulling the tab upwards (2).
- Fill the tank (3) with fresh clean water, taking care not to exceed the maximum level shown on the level indicator (1.4 litres) (13). Exceeding the maximum level may cause water to leak and irreparable damage to the appliance.



To make it easier to fill the tank, make sure that the lid is completely open.



Caution

- Do not use the drip coffee machine if there is no water in the tank.
- Only put fresh clean water in the tank.
- Do not use liquids other than water.



The components intended to come into contact with food are made of materials that comply with the provisions of current legislation.



Use

- Hold the lid of the water tank open and insert the permanent filter (6) into the filter holder (4).
- Fill with the amount of coffee required, according to the number of cups to be prepared, using the scoop (14) provided.





• The permanent filter allows you to prepare filter coffee without using paper filters. However, according to your own preference, a paper filter #4 can be used instead.

• Place the paper filter in the filter holder and add the required amount of coffee.

• One level scoop of ground coffee is approximately equivalent to one cup of filter coffee. However, the amount of ground coffee to be used may vary according to personal taste.

• Use good quality medium ground coffee.

- Close the lid by lowering the tab (2).
- Place the jug (11) with the lid (10) on the keep warm plate (15). Make sure that the lid (10) fits perfectly into the anti-drip valve (5).
- Press button (17)  to start brewing coffee. The LED on button (17)  lights up and flashes quickly for the entire time the coffee is being brewed.



It is normal for steam to be produced while the coffee is being brewed.



Caution

Do not open the lid of the water tank while the coffee is being brewed.

- You can stop brewing coffee at any time by pressing button (17) .



Caution

• Do not open the lid of the drip coffee machine as soon as the brewing cycle has finished. Wait for at least 5 minutes after the coffee has been brewed before opening the lid.

• After 5 minutes, it is possible to remove and clean the filter and fill the tank again to brew more coffee.



If button (17)  is not pressed, coffee will continue to be brewed according to the automatic settings and fill the jug completely (10 cups) or until there is no water remaining in the tank. The other buttons, even if pressed, have no effect and do not stop coffee from being brewed.

**Caution**

- The filter holder and the permanent filter may be hot after the coffee has been brewed. Be careful when removing them.
- The base of the jug may be very hot after the coffee has been brewed. Take care when removing it and make sure that you do not place the jug on a heat-sensitive surface.
- The Keep Warm plate remains warm after the coffee has been brewed: be careful not to touch it when removing the jug.



The **KEEP WARM**  mode cannot be activated if brewing is stopped manually or if the **4 CUPS** mode is active.

4 cups function

Brews a small amount of coffee, corresponding to approximately 4 cups:

- Press button (19)  to activate it, the LED turns on.
- Press button (19)  again to deactivate it.

Autostart function





The automatic start time has to be set before the automatic start function can be programmed.

KEEP WARM mode 

Once the coffee has been brewed, the **KEEP WARM**  mode is activated automatically and keeps the warming plate on for 60 minutes. In this way, the coffee will remain hot for 60 minutes after it has been brewed.

In the **KEEP WARM**  mode, the LED of button (17)  flashes slowly and the **KEEP WARM**  icon lights up on the display.

At the end of the **KEEP WARM**  mode, button (17)  turns off automatically.

The **KEEP WARM**  mode can be stopped manually at any time by pressing button (17) : the LED of button (17)  and the **KEEP WARM**  icon turn off.



Setting the Autostart time

- Make sure that the time displayed is correct. Otherwise, set the correct time as described in section "Machine settings".
- Press and hold the button for 3 seconds to set the time for the automatic start mode: the LED of the button and the time display (HH:MM) start to flash.
- Move the lever up (+) or down (-) to set the time.
- Confirm the time by moving the lever to the central position and press (OK): the set time will be saved automatically and will be used until it is modified.



Use

Autostart function activation

- Press button (20) : the LED of button (20)  will light up and the hours and minutes of the set start time for brewing the coffee will flash for a few seconds on the display. Then the current time will be displayed.



You can also select the intensity (Aroma button) and the 4-cup function when using the Autostart function. Press the relative buttons to memorize the functions.

- The appliance remains in **AUTOSTART** mode until the pre-set time is reached. Coffee will be brewed automatically.
- Press button (20)  at any time to exit from this mode.

Machine settings

The appliance allows you to personalise some settings:

- clock settings
- time format
- water hardness
- activation / deactivation of the acoustic signals

Setting the clock

The time has to be set when you use the appliance for the first time:

- Plug the appliance into an electrical outlet.
- The symbols on the display flash.
- Set the time by moving the lever up (+) to increase the value or down (-) to decrease it. Move the lever to the central position and press (OK) to confirm.



- Set by following the same procedure.
- After confirming the minutes setting, the appliance activates the **CLOCK** mode.



When the appliance is switched on for the first time, the default time will be shown in the 12 h time format, indicating **AM/PM**. To change the time format, see the "Time format settings menu" section.

Time format settings menu

The time format can be set to display the time in a 12 h or an **AM/PM** format.

- Access the settings menu by pressing and holding buttons (18)  and (19)  at the same time for 3 seconds. Select **SE01** by moving the lever and pressing it to the "OK" position.
- Move the lever to select the required format (12 h or 24 h)
- Move the lever to the central position and press (OK) to confirm the setting. The format will flash for 2 seconds: the setting is saved.



The time format only needs to be set once and the setting is saved.





Modifying the time

- Make sure that the required format (12 h or 24 h) has been set as indicated in the previous section.
- Keep the lever (9) pressed in the central position for 3 seconds: the display starts to flash.
- Modify the hours and minutes as indicated in the "Setting the clock" section.

Water hardness settings menu



The water hardness can be set by selecting one of the 3 settings: **HARD**, **MEDIUM** and **SOFT**.

- Access the settings menu by pressing and holding buttons (18)  and (19)  at the same time for 3 seconds. Select **SE02** by moving the lever: the display shows **HA02** by default (medium hardness).
- Move the lever up (+) or down (-) to set the required level: **HA01** (soft), **HA02** (medium) and **HA03** (hard).
- Move the lever to the central position and press (OK) to confirm the setting.

The selection flashes for 2 seconds: the setting is saved.

Sounds settings menu

The sounds can be enabled/disabled as follows:

- Access the settings menu by pressing and holding buttons (18)  and (19)  at the same time for 3 seconds. Select **SE03** by moving the lever (9).
- Move the lever up or down until **OFF** appears on the display to disable the sounds or **ON** to enable them.
- Move the lever to the central position and press (OK) to confirm the setting. The selection flashes for 2 seconds: the setting is saved.



Cleaning and care

4 Cleaning and maintenance

4.1 Instructions



Improper use

Danger of electrocution

- Unplug the drip coffee machine before cleaning it.
- Do not immerse the drip coffee machine in water or other liquids.
- Allow the drip coffee machine cool down before cleaning it.



Improper use

Risk of damage to surfaces

- Do not use steam jets to clean the drip coffee machine.
- Do not use cleaning products containing chlorine, ammonia or bleach on parts with metal surface finishes (e.g. anodised, nickel- or chrome-plated).
- Do not use abrasive or corrosive detergents (e.g. powder products, stain removers and metallic scourers).
- Do not use rough or abrasive materials or sharp metal scrapers.

4.2 Cleaning the body of the machine

To keep the outer surface of the machine in good condition, it should be cleaned regularly after use. Let the appliance cool down first. Clean with a soft, damp cloth.

4.3 Cleaning the drip coffee machine components

The permanent filter and the filter holder can be washed by hand under running water to remove coffee residues or in a dishwasher.

The jug can be washed in hot soapy water using a soft brush after emptying out any coffee residues in order to prevent stains.

Always dry the components thoroughly after cleaning.



Improper use

Do not wash the jug in a dishwasher as it could become permanently damaged

4.4 Rinsing the internal circuits

Rinse the internal circuits after filling the tank:

- 1) Place the jug (11) on the Keep Warm plate (15) **WITHOUT** putting ground coffee into the filter.
- 2) Press button (17) .
- 3) Wait for the cycle to finish and empty the jug.
- 4) The appliance is now ready for use.



4.5 Descaling



Caution

- Coffee can be prepared even if the **DESCALING** alarm is active.
- Carry out a descaling cycle when prompted to do so by the appliance.
- **Limescale deposits can prevent the appliance from working correctly, especially if the water is particularly hard.**



Regularly descaling the appliance helps to preserve the aroma of the coffee and to keep the appliance in good working order.







Danger of personal injury and damage to the appliance

- The descaler contains acid which can irritate the skin and eyes.
- Follow the manufacturer's instructions and safety warnings on the pack to the letter; they will also tell you what to do in the event of contact with skin or eyes.
- Use descaling products recommended by Smeg to avoid damaging the drip coffee machine.

The **DESCALING** icon on the display starts to flash.

To start the descaling cycle:

- Pour water and descaler into the water tank up to the maximum level indicated and using the amount recommended by the descaler manufacturer.
- Press buttons (17)  and (20)  at the same time for 5 seconds to activate the **DESCALING** mode: the LEDs of buttons (17)  and (20)  flash and the **DESCALING** icon continues to flash until the cycle finishes.
- At the end of the cycle, the display reverts to **CLOCK** mode and the **DESCALING** icon disappears from the display.
- Carry out a rinse cycle (see section "4.4 Rinsing the internal circuits").

The appliance automatically indicates when descaling should be carried out according to the set water hardness (see section "Water hardness settings menu").



Cleaning and care

4.6 What to do if...

Problem	Possible causes	Solution
Coffee does not come out	No water in tank.	Fill the tank.
	Scale build-up.	Perform a descaling cycle.
Coffee takes a long time to be dispensed	Scale build-up.	Perform a descaling cycle.
The coffee has an acidic taste	Possible stagnation of coffee in the circuits.	Rinse as described in section "4.5 Descaling".
	The filter is not positioned correctly.	Insert the filter correctly in the filter holder.
The drip coffee machine overflows	The jug is not positioned correctly on the base.	Make sure that the jug is positioned correctly under the boiler outlet.
	There is no lid on the jug.	Place the lid on the jug.
	Excessive amount of coffee.	Place up to a maximum of 5 level scoops of ground coffee into the permanent filter.
	Coffee is too finely ground.	Use ground coffee for drip coffee machines.
Only water comes out of the drip coffee machine	No ground coffee in the filter.	Put the required amount of ground coffee into the filter.



If the problem has not been resolved or in the case of other types of fault, contact your local technical support centre.

The manufacturer reserves the right to make any changes deemed necessary for the improvement of its products without prior notice. The illustrations and descriptions contained in this manual are therefore not binding and are merely indicative.

عميلنا العزيز ، شكراً لك على شراء أحد أجهزتنا. تعد منتجاتنا فريدة لأنها تجمع بين الأسلوب المميز والحلول التقنية المبتكرة. وهي تتناسب تمامًا مع المنتجات الأخرى في مجموعتنا وتعمل بنفس القدر كتصميمات قائمة بذاتها في مطبخك. نأمل أن تستمتع باستخدام هذا الجهاز الجديد! وتفضلوا بقبول وافر الاحترام والتقدير.