

USER MANUAL  
COFFEE MACHINE

EN

MANUEL DE L'UTILISATEUR  
MACHINE À CAFÉ

FR

MANUAL DE USO  
CAFETERA

ES



We advise you to read this manual carefully, as it contains all the instructions for managing the appliance's aesthetic and functional qualities.

For further information on the product: [www.smegusa.com](http://www.smegusa.com)

Nous conseillons de lire attentivement ce manuel, qui comprend toutes les indications pour maintenir inaltérées les qualités esthétiques et fonctionnelles de l'appareil acheté.

Pour obtenir des informations supplémentaires sur le produit : [www.smegusa.com](http://www.smegusa.com)

Aconsejamos leer atentamente este manual que contienen todas las indicaciones para mantener inalterada la calidad estética y funcional del aparato adquirido.

Más información sobre el producto en: [www.smegusa.com](http://www.smegusa.com)

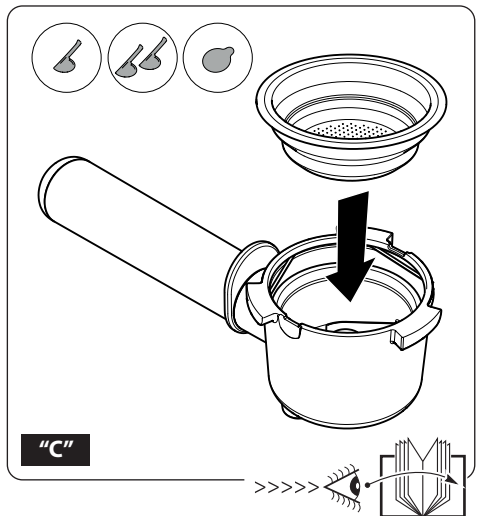
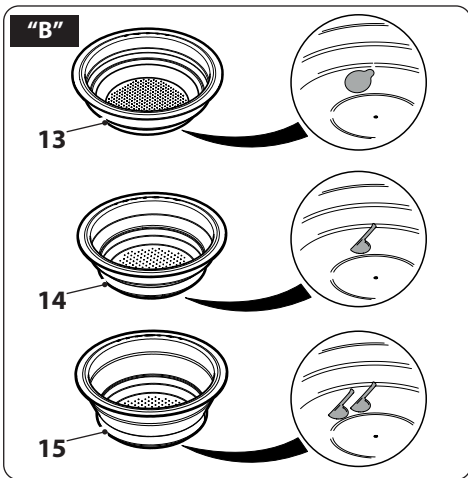
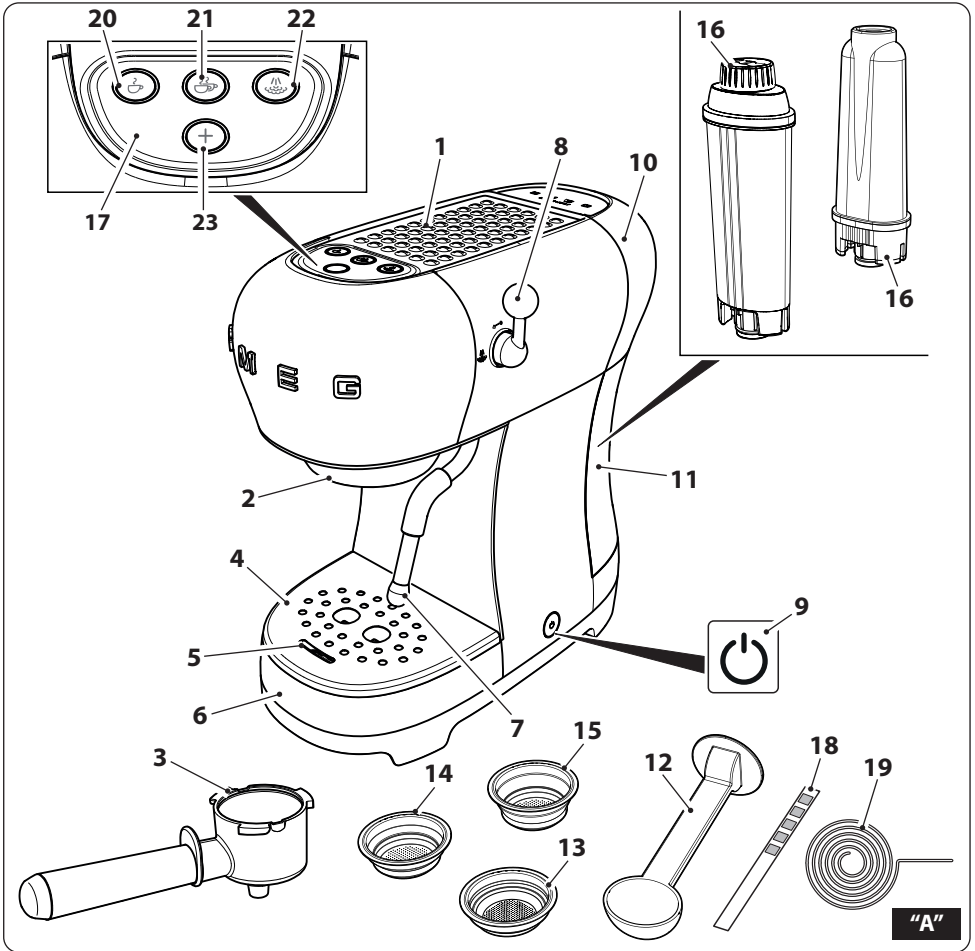

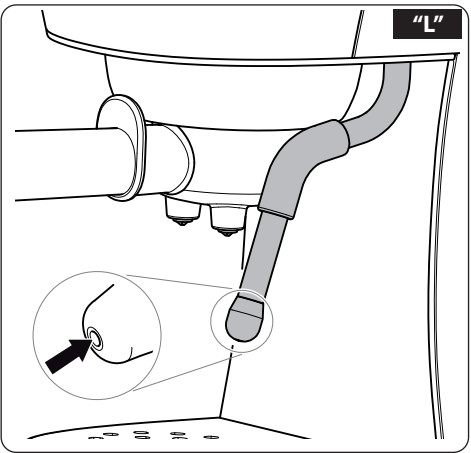
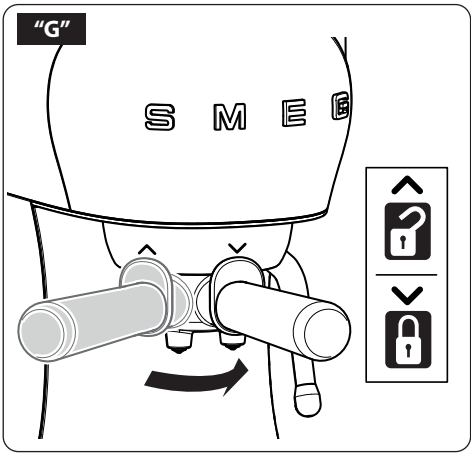
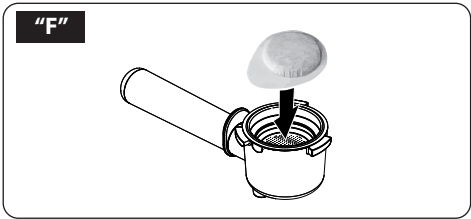
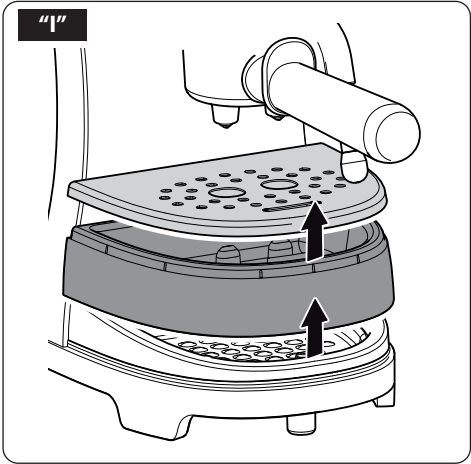
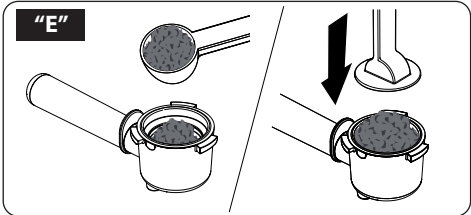
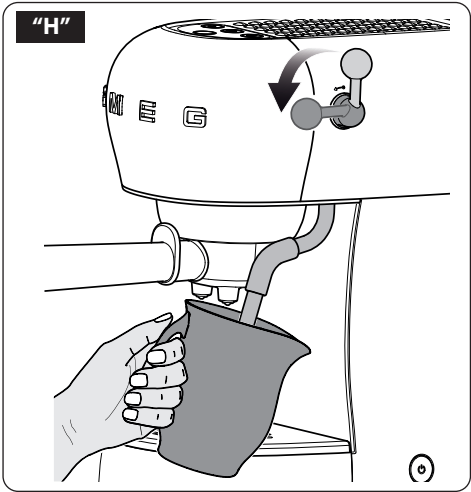
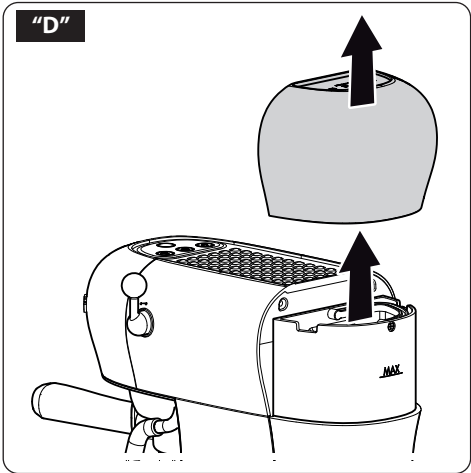

**Important information for the user**  
**Informations importantes pour l'utilisateur**  
**Información importante para el usuario**

 **Instructions / Instructions / Instrucciones**

 **Description / Description / Descripción**

 **Use / Utilisation / Uso**

 **Cleaning and care / Nettoyage et entretien / Limpieza y cuidado**

 **Safety instructions / Consignes de sécurité / Instrucciones de seguridad**

 **Information / Informations / Información**

 **Advice / Conseil / Recomendaciones**

The manufacturer reserves the right to make any changes deemed useful for the improvement of its products without prior notice. The illustrations and descriptions contained in this manual are therefore not binding and are merely indicative.

Le fabricant se réserve la faculté d'apporter, sans préavis, toutes les modifications qu'il jugera utiles pour l'amélioration de ses produits. Les illustrations et les descriptions figurant dans ce manuel ne sont pas contraignantes et n'ont qu'une valeur indicative.

El fabricante se reserva el derecho a aportar sin aviso previo todas las modificaciones que considere útiles para la mejora de sus propios productos. Las ilustraciones y las descripciones contenidas en este manual no comprometen, por tanto, al fabricante y tienen un valor meramente indicativo.



## Important instructions

**WARNING:** If the instructions contained in this manual are not followed precisely, fire or explosion may result causing property damage, personal injury or death.



### READ AND SAVE THESE INSTRUCTIONS

Your safety and the safety of others are very important.

We have provided many important safety messages throughout this manual and on the appliance.

Read all the instructions before using the appliance and always obey all safety messages.

### WARNING



- To reduce the risk of fire or electric shock, do not remove the cover (or back).
- No user-serviceable parts inside!
- Repair should be done by authorized service personnel only.



### RECOGNIZE SAFETY INFORMATION

This is a safety alert symbol. This symbol alerts you to potential hazards that can result in severe personal injury or death.

### UNDERSTAND SIGNAL WORDS

A signal word - DANGER, WARNING or CAUTION - is used with the safety alert symbol. DANGER denotes the most serious hazards. It means you could be killed or seriously injured if you do not immediately follow the instructions.

WARNING means you could be killed or seriously injured if the instructions are not followed. CAUTION indicates a potentially hazardous situation, which, if not avoided, could result in minor to moderate injury.

# IMPORTANT INSTRUCTIONS

## ATTENTION



- This appliance is intended for use in the home only.
- Use this appliance only for its intended purpose. The manufacturer cannot be held liable for damage caused by improper use of this appliance.
- This appliance complies with current safety regulations. Improper use of this appliance can result in personal injury and material damage.
- Read all the instructions before installing or using the appliance for the first time.
- Keep these operating instructions in a safe place and pass them on to any future user.

The safety messages will inform you of potential hazards, on how to avoid the risk of injury and what can occur if the instructions are not followed.

**IMPORTANT: Observe all codes and ordinances in force.**

**WARNING: For your safety, the instructions contained in this manual must be followed to minimize the risk of fire or explosion and to prevent property damage, personal injury or death.**

Do not store or use gasoline or other flammable vapors, liquids or materials near this or any other appliance.



**NOTE:** This appliance is NOT designed for installation in manufactured (mobile) homes or in recreational vehicles (RVs).



**NOTE:**

**GROUNDING PLUG** (for product manufactured with a grounded plug)

As a safety feature, this product is equipped with grounded plug, which will only fit into a three-prong outlet. Do not attempt to bypass this safety feature. Improper connection of the grounding conductor may result in the risk of electric shock. Consult a qualified electrician if you have any doubts on whether the outlet is properly grounded.



# IMPORTANT SAFEGUARDS



EN

**WARNING** When using electrical appliances, basic safety precautions should always be followed to reduce the risk of fire, electric shock, and / or injury to person including the following:



## 1 Warnings

Follow all safety precautions to ensure safe use of the appliance.

- Read all instructions.
- Do not touch hot surfaces. Use handles or knobs.
- Before using the appliance, read this user manual carefully.
- Do not use the appliance outdoors.
- This appliance is for household use only.
- Do not use the appliance for other than its intended use.
- Do not allow children to use the appliance.
- Children should not play with the appliance. Keep the appliance out of the reach of children.
- Keep the packaging material (plastic bags, expanded polystyrene) out of the reach of children.
- Close supervision is necessary when any appliance is used by or near children.
- Turn off the appliance immediately after use.
- Do not leave the appliance unattended while it is running.
- Disconnect the appliance from the wall outlet before assembly, disassembly, cleaning and after each use.
- Always attach plug to appliance first, then plug cord into the wall outlet. To disconnect, turn any control to "off," then remove plug from wall outlet.
- Turn the appliance OFF, then unplug from the outlet when not in use, before assembling or disassembling parts and before cleaning. To unplug, grasp the plug and pull from the outlet. Never pull from the power cord.
- To protect against fire, electrical shock and personal injury, do not immerse the appliance, the power cord or plug in water or any other liquid.
- Do not touch the appliance or the plug with wet hands.
- Never try to extinguish a flame/fire with water: turn off the appliance, unplug it from the outlet and cover the flame with a lid or a fire blanket.
- Do not use the appliance if the power cord or plug is damaged or if the appliance has been dropped or damaged in any way.
- Do not let cord hang over edge of table or counter, or touch hot surfaces.
- Do not operate any appliance with a damaged cord or plug or after the appliance malfunctions, or has been damaged in any manner. Return appliance to an authorized service facility for examination, repair or adjustment.
- Make sure the power cord does not come in contact with sharp edges.

## SAVE THESE INSTRUCTIONS



# IMPORTANT SAFEGUARDS

- Do not pull on the cord to remove the plug from the socket.
- Do not place the appliance on or near switched-on gas or electric burners, inside an oven, or near heat sources.
- Do not touch hot surfaces. Use handles and knobs.
- Do not place the appliance near faucets or sinks.
- Never attempt to repair the appliance yourself or without the help of a qualified technician. Failing to do this will void the warranty.
- In case of malfunction, have the appliance repaired by a qualified technician.
- Do not make any changes to the appliance.
- Make sure that the power outlet used is always freely accessible, because only in this way can it be unplugged when necessary.
- To remove the plug from the power outlet, operate directly on the plug. Never pull the cable, it could be damaged.
- If the appliance should break down, do not attempt to repair it.
- Do not allow the power supply cable to dangle over the edge of the table or other surface or to touch hot surfaces.
- If the plug or power supply cable are damaged, have them replaced exclusively by the Technical After-sales centre, so as to prevent all risks.
- Check hopper for presence of foreign objects before using.
- The instructions for coffee-makers shall state that cleaning and user maintenance shall not be made by children without supervision.

## 1.1 For this appliance

- Only insert water into the appropriate tank. Use fresh, clean water.
- The appliance shall not be placed in a cabinet when in use.
- Allow the appliance to cool down before cleaning.
- The appliance generates heat and produces hot water and steam during operation. Avoid contact with boiling steam or water.
- Do not fill the water container beyond the maximum limit indicated.
- Do not use without water in the tank or without a tank.
- Only use the appliance indoors and at a maximum altitude of 2000 meters.
- Use only coffee beans to obtain the powder, do not put already ground coffee in the coffee bean hopper.
- Use the device only to prepare coffee-based drinks from grinding coffee beans or to dispense hot water. Other uses are improper.
- Use only original spare parts from the manufacturer. The use of spare parts not recommended by the manufacturer may cause fire, electric shock or injury to persons.



To avoid the risk of injury, do not open the brew chamber during the brew process.

## SAVE THESE INSTRUCTIONS

# IMPORTANT SAFEGUARDS



- Place the appliance on a flat, dry surface.
- Avoid wetting or spraying liquid on the appliance. In case of contact with liquid, immediately unplug the cord from the electrical outlet and dry thoroughly: Risk of electric shock!
- Do not use abrasive cleaners or sharp objects to clean the appliance.
- The use of an accessory not evaluated for use with this appliance may cause injuries.
- Do not install the appliance in an environment that is not suitable.
- Do not place the appliance on or in proximity of electric or gas cookers, or in a heated oven.
- This appliance is not intended for use by persons (including children) with reduced physical, sensory, or mental capabilities, or lack of experience and knowledge, unless they are closely supervised and instructed concerning use of the appliance by a person responsible for their safety. Children should be supervised to ensure that they do not play with the appliance.
- Avoid contacting moving parts.
- This appliance has important markings on the plug blade. Contact a qualified technician to replace the plug with a suitable one if damaged.
- Connect the appliance only to a power outlet installed perfectly.
- It is recommended to delicately dry the machine before use, since there may be slight traces of residual moisture originating from quality controls.

## 1.2 Electrical Cord

- a) A short power-supply cord (or detachable power-supply cord) is provided to reduce risks resulting from becoming entangled in or tripping over a longer cord.
- b) Longer detachable power-supply cords or extension cords are available and may be used if care is exercised in their use.
- c) If a long detachable power-supply cord or extension cord is used:
  1. The marked electrical rating of the detachable power-supply cord or extension cord should be at least as great as the electrical rating of the appliance;
  2. If the appliance is of the grounded type, the extension cord should be a grounding-type 3-wire cord; and
  3. The longer cord should be arranged so that it will not drape over the counter top or table top where it can be pulled on by children or tripped over.

## 1.3 Connect the appliance

Make sure that the mains voltage corresponds with that indicated on the data plate on the bottom of the appliance.

Connect the appliance only to a power outlet installed perfectly.

If the plug and power outlet are incompatible, have the power outlet replaced with a suitable type by qualified staff.

# SAVE THESE INSTRUCTIONS



# IMPORTANT INSTRUCTIONS

## 1.4 This user's manual

This user's manual is an integral part of the appliance and must be kept intact and available to the user throughout its life cycle.

## 1.5 Use compliant with destination

- The appliance is intended for household and similar use, such as:
  - in the kitchen area for the staff of shops, offices and other work environments;
  - in bed and breakfast and agritourism accommodation;
  - by guests at hotels and motels, and in residential environments.
- Other uses, in restaurants, bars and cafes for example, are improper.

## 1.6 Manufacturer's liability

The manufacturer declines all liability for damage undergone by persons and objects due to:

- use of the appliance different from that envisioned;
- user manual has not been read;
- tampering of individual parts of the appliance;
- use of non-original spare parts;
- failure to comply with safety recommendations.

## 1.7 Identification plate

The identification plate lists the technical data, serial number and brand name. The identification plate must never be removed.

## 1.8 Disposal



Power voltage  
Risk of electric shock

- Unplug the appliance.
- Unplug the cord from the wall outlet.
- **Old electrical equipment must not be disposed of with household waste!** In accordance with the law in force, electrical appliances at the end of their life should be taken to separate collection facilities for electrical and electronic waste. This is so that valuable materials from old appliances can be recycled and the environment can be protected. For more information, please contact your local authorities or recycling center employees.

Note that non-polluting and recyclable materials are used for packaging the appliance.

- Dispose of the packaging materials at appropriate differentiated waste collection centers.



Plastic packaging  
Risk of suffocation

- Do not leave the packaging or any part of it unattended.
- Do not allow children to play with the plastic packaging bags.

# SAVE THESE INSTRUCTIONS



## 2 Description of the appliance (Fig. A)

- 1 Cup-warmer shelf.
- 2 Dispensing unit.
- 3 Filter-holder.
- 4 Cup tray.
- 5 Level indicator.
- 6 Drip tray.
- 7 Steam wand.
- 8 Steam knob.
- 9 ON/OFF switch.
- 10 Water tank lid.
- 11 Water tank (1 litre).
- 12 Measuring/tamping scoop.
- 13 Coffee pod filter.
- 14 Single filter.
- 15 Double filter.
- 16 Water softener filter (optional).
- 17 Control panel.
- 18 Water hardness test strip.
- 19 Steam wand cleaning needle.

### 2.1 Description of accessories

Accessories included:

#### Measuring/tamping scoop (12)

- Accessory to use to dose the amount of ground coffee into the filter and press it inside.

#### Filters (13, 14, 15)

- This machine includes 3 filters; two pressurised for ground coffee and one for paper coffee pods (Fig.B).

#### Water hardness test strip (18)

- Use the strip supplied to detect the hardness of the water used as indicated in the "Machine setting - Water hardness" paragraph.

## 2.2 Description of controls (Fig. A)



### ON/OFF key (9)



Voltage is supplied to or removed from the machine by pressing this button.

### Dispensing programme change key (23)

The product has 4 espresso functions and steam function, accessible through two menus, *White Menu* and *Orange Menu*.

Once the machine is ready for use, by pressing this key it is possible to change the dispensing menu from "White" to "Orange" and vice versa.

| Key  | White menu function |
|--|---------------------|
|  (20) | Single espresso     |
|  (21) | Double espresso     |
|  (22) | Steam dispensing    |

| Key  | Orange menu function |
|--|----------------------|
|  (20)  | Long single espresso |
|  (21) | Long double espresso |
|  (22) | Steam dispensing     |

### Descaling alarm (22)

When the key flashes with an orange light, it indicates that a descaling process is necessary.



## Use

### 2.3 Before commissioning (Fig. D)

- Remove any labels and stickers from the coffee machine.
- Thoroughly wash and dry the coffee machine components (see "4 Cleaning and maintenance").
- Remove the lid (10) pulling it upwards and then slide the tank out (11).
- Fill the tank (11) with cool, clean water directly from the tap or using a jug, ensuring not exceed the maximum level indicated on the tank.
- Re-introduce the tank (11) pressing it lightly in a way to open the valves located on the bottom of the tank itself.



Do not use the coffee machine without water in the tank or without the water tank fitted.  
**FAULT HAZARD!**



The parts that may come into contact with foodstuffs are made using materials that comply with the provisions of the legislation in force.

## 3 Use



Before starting the coffee machine, carefully read chapter "1 Warnings" and section "2.3 Before commissioning".

### 3.1 Commissioning (Fig. G and H)



On commissioning, the internal circuits must be rinsed. Proceed as described below.

- Switch the coffee machine on by pressing the ON/OFF switch (9): the LEDs of keys (20), (21) and (22) flash to indicate that the pre-set temperature is being reached. The coffee machine is ready for use as soon as the three LEDs stop flashing and have a fixed light.
- Attach the filter holder (3) with 2-cup filter (15) to the coffee machine.
- Position a container under the coffee dispensing nozzles and press the key (21).
- Repeat this procedure 5 times.
- Position a container under the hot water/steam wand (7).
- Turn the steam knob (8) anti-clockwise and dispense 100 ml of water.
- Turn the steam knob (8) again in a clockwise direction to end the operation.



It is recommended to rinse the internal circuits also when the coffee machine has not been used for a long period of time.



### 3.2 Dispensing programme change (Fig. A)

- The machine has two dispensing menus in its memory: *White Menu* and *Orange Menu*.  
To pass from one program to another, press the key (23) .
- In the *White Menu* all of the buttons have white lights, in the *Orange Menu* all of the keys have orange lights.
- For the specific functions of each menu, refer to section "2.2 Description of controls".

### 3.3 Preparing espresso coffee



The coffee machine has three filters (FIG. B):  
1-cup filter (14), 2-cup filter (15) and pod filter (13). The corresponding icon is found under each filter.



To avoid spraying, do not remove the filter-holder during or immediately after dispensing: wait for a few seconds after dispensing has stopped.  
**BURNS HAZARD!**

#### Recommendations for hotter coffee (Fig. G)

In order to obtain a hotter espresso coffee, it is recommended to:

- Heat the cups before making the coffee, by rinsing them under hot water.
- Attach the filter holder (3) to the machine with the filter inserted, without adding coffee. Press the 1-cup key (20) to dispense hot water into the cup to be used to make the coffee, this will heat the cup.



When the machine has not been used for a while (more than 30 minutes), it is normal for the first cups of coffee not to be at the right temperature. Repeat the procedure described to obtain a hotter coffee.

#### Ground coffee (Fig. B-C-E-G)

- Insert the 1-cup (14) or 2-cup ground coffee filter (15) into the filter holder (3).
- Fill the filter (14) or (15) with ground coffee, making sure finely ground coffee is used, which is suitable for the espresso.
- Distribute the ground coffee evenly and tamp down using the tamping scoop (12).
- Remove any excess ground coffee from the edge of the filter holder (3). Attach the filter holder to the dispensing unit (2) and turn it to the right until it locks in place.



- For one cup, fill the relevant filter (14) with a level measure of coffee (approx. 7 grams.)
- For two cups, fill the filter (15) with two level measures.
- To obtain a strong coffee, tamp down the coffee firmly.
- To obtain a weak coffee, tamp down the coffee less.
- Before introducing the filter-holder into the dispensing unit, make sure the edge of the filter is cleaned to remove any coffee residues.

- Position the cup or cups under the filter holder nozzles.
- Press the key relative to the desired function. Preparation ends automatically for every function selected.
- For the specific beverages, refer to section "2.2 Description of controls".



## Use

- Once dispensing has ended, wait a few seconds and then remove the filter-holder (3) by turning it to the left.

### Coffee pods (Fig. B-C-F-G)

- Insert the coffee pod filter (13) into the filter holder (3).
- Insert the pod into the filter holder (3), centring it as much as possible. Attach the filter holder (3) to the dispensing unit (2).
- Position the cup or cups under the filter holder nozzles (3) and press the dispensing key (20).
- Once the coffee has been dispensed, turn the filter holder (3) to the left to remove it.



Before dispensing, make sure that the pod flap remains inside the filter, and not on the edge.



- Dispensing can be stopped at any time by pressing the dispensing key again.



After having waited a few seconds following the end of every dispensing operation, it is advised to release the filter-holder and clean the coffee residues from the filter.

### Setting the quantity of coffee

The quantity of coffee dispensed can be customised for every function.

To modify the quantity of coffee dispensed by the machine:

- Position a small or large cup under the dispenser (2).
- Press one of the keys relevant to the beverage to be dispensed (20) or (21)

for at least 3 seconds, until the LED of the relative button remains on.

- On reaching the desired quantity, stop dispensing by pressing the key again.
- The length has been set and is stored permanently.

### 3.4 Dispensing steam and preparing a cappuccino (Fig. H and I)

- Press the key (22), which starts to flash. Wait for the key to have a fixed light, which indicates that the correct steam dispensing temperature has been reached.
- When the LED (22) has a fixed light, position an empty recipient under the steam wand (7) and turn the steam knob (8) anti-clockwise to discharge any water present and then close the knob.
- Fill a container with 100 ml of cold milk, for every cappuccino to be prepared.
- Position the container with milk under the milk frothing wand (7), positioning the tip of the frothing wand in contact with the milk.
- Turn the steam knob (8) anti-clockwise to dispense the steam.
- Successively, introduce the steam wand into the milk, creating a vortex with the container of milk.
- Once the ideal temperature has been reached, stop dispensing by turning the steam knob (8) clockwise.
- Pour the frothy milk into the cups with the previously-prepared espresso.



- To make several cappuccinos, first prepare all the coffees and then froth the milk for all of them together.
- At the end of the operation, clean the steam wand (7) immediately using a damp cloth.





- Discharge any milk residues by turning the steam knob to let the steam out.
- Do not dispense steam for longer than 60 seconds max.
- After heating the milk, the internal part of the steam wand (7) must be cleaned by dispensing steam for a few seconds.
- Clean the steam wand (7) every time it is used, to prevent the deposit of milk residues or clogging. For complete cleaning of the steam wand, see the "Cleaning and Maintenance" paragraph.



The drip tray (6) can be removed if tall cups are used.



The result of the steam function can be affected by the ingredients used. To obtain a good cappuccino, we recommend using semi-skimmed or full-fat milk at fridge temperature (about 5°C).



To prevent obtaining milk with not much froth or large bubbles, always clean the steam wand as described in paragraph "4 Cleaning and maintenance".

## How to cool the heating element (Fig. H)



When the temperature of the heating element is too high to dispense coffee, buttons (20) and (21) flash alternately.

The heating element must be cooled down if you wish to prepare a coffee immediately after frothing milk.

If the heating element is not cooled down, the coffee dispensed will taste burned.

To cool it quickly, proceed as follows:

- Position a container underneath the steam wand (7) and turn the steam knob (8) anti-clockwise to dispense hot water.
- The steam wand (7) will initially dispense steam. Burns hazard. Successively, hot water will be dispensed. This means that the heating element has reached the correct temperature to dispense coffee.
- Turn the steam knob (8) clockwise and prepare the coffee.

## 3.5 Dispensing hot water (Fig. H)

- Turn the machine on using the ON/OFF switch and wait until the coffee dispensing LEDs have a fixed light.
- Position a recipient under the steam wand (7).
- Turn the steam knob (8) anti-clockwise and dispense hot water.
- Stop dispensing by turning the steam knob (8) clockwise.











## 3.6 Accessing the programming menu and changing the settings

- Make sure that the machine is ready for use and maintenance. Press the key (23) for 5 seconds until all keys start to flash: the machine is in programming mode.
- Set the machine to meet your requirements (see the next page).
- To exit the menu, wait for 30 seconds without pressing any key.

### Setting the coffee temperature









- Access the programming menu.
- Press the key (20) to set the temperature of the coffee.
- The key (20) flashes 3 times, after which the current setting LEDs turn on:

| LEDs   | Setting the temperature |
|--|-------------------------|
|       | Low                     |
|       | Medium                  |
|    | High                    |

- The LEDs start to flash in sequence.
- Press the key corresponding to the desired temperature: low (20), medium (21) or high (22).
- The key selected flashes to indicate the selection has been stored and a single sound is emitted if the acoustic signals are activated.



### Setting water hardness

- The machine is factory set to “Hard Water Level”. The machine can also be set according to the actual water hardness in the various regions for less frequent descaling.
- If you don’t know the water hardness, use the test strip supplied (18) and follow the instructions below.
- Remove the reactive strip supplied from its packaging.
- Fully submerge the strip in a glass of water for about one second.
- Remove the strip from the water and shake it slightly. Read the results after approx. one minute.  
If 5 blue stripes appear on the strip, select the “soft water” setting.  
If 1 or 2 pink stripes appear on the strip, select the “average water” setting.  
If 3, 4 or 5 pink stripes appear on the strip, select the “hard water” setting.
- Access the programming menu.
- Press the key (21) to set water hardness.
- The key (21) flashes 3 times, after which the current setting LEDs turn on:

| LEDs  | Setting water |
|---|---------------|
|    | Soft          |
|    | Medium        |
|    | Hard          |



- The LEDs start to flash in sequence.
- Press the key corresponding to water hardness:

|  <b>Soft</b> |  <b>Medium</b> |  <b>Hard</b> |
|---|---|---|
| <10°dH  | 10°dH - 20°dH   | >20°dH  |
| <18°fH  | 18°fH - 36°fH   | >36°fH  |
| <180 mg/l<br>CaCo3  | 180-300 mg/l<br>CaCo3   | 360 mg/l<br>CaCo3   |

- The key selected flashes to indicate the selection has been stored and a single sound is emitted if the acoustic signals are activated.



To prolong machine operation and preserve the aroma and flavour of the coffee, use of the Smeg Water Softener Filter is recommended (optional, not supplied). For installation and operation, follow the instructions accompanying the accessory. Once installed, set the level of water hardness at "Soft", following the indications in the previous paragraph.

## Setting the automatic shut-off time

In order to save energy, the coffee machine has an automatic shut-off function and will turn itself off when it has not been used for a certain period of time.









To turn the appliance back on, press any button on the control panel.

To set the automatic shut-off time:

- Access the programming menu (see section "3.6 Access programming menu and change settings").

Press the key (22) to set the automatic shut-off time.

- The key (22) flashes 3 times, after which the current setting LEDs turn on:

| <b>LEDs</b>   | <b>Time setting</b> |
|---|---------------------|
|    | 10 minutes          |
|    | 30 minutes          |
|    | 1 hour              |

- The LEDs start to flash in sequence.
- Press the button corresponding to the time you wish to set, choosing from 10 minutes (20), 30 minutes (21) or 1 hour (22).
- The key selected flashes to indicate the selection has been stored and a single sound is emitted if the acoustic signals are activated.

## Restoring factory values

To restore factory settings:

- Hold keys (21) and (23) down simultaneously for at least 10 seconds.
- All of the buttons will flash together once to indicate that the original settings have been reset.

## Activation/deactivation of acoustic signals

- The machine is set by default with the acoustic signals deactivated.
- The acoustic signals can be disabled/enabled by holding keys (20) and (23) down for 5 seconds;
- The key (20) flashes three times indicating that the setting has been stored.



# Cleaning and maintenance

## 4 Cleaning and maintenance

### 4.1 Warnings



Electrocution hazard.

- Remove the plug from the power outlet before cleaning the coffee machine.
- Never immerse the coffee machine in water or other liquids.
- Allow the coffee machine to cool down before cleaning.



Risk of damage to the surfaces.

- Do not use steam jets to clean the coffee machine.
- Do not use cleaning products containing chlorine, ammonia or bleach on parts with metal surface finishes (e.g. anodised, nickel or chrome-plated).
- Do not use abrasive or corrosive detergents (e.g. powder products, stain removers and metal scourers).
- Do not use rough or abrasive materials or sharp metal scrapers.

### 4.2 Cleaning the coffee machine body

To keep the external surfaces in good condition, they must be cleaned regularly after all use and when they have cooled down. Clean with a soft, damp cloth.

### 4.3 Cleaning the coffee machine components

#### Cleaning the drip tray (Fig. I)

The drip tray (6) is equipped with a red float (5) which projects from the cup holder tray when the maximum liquid level is exceeded.

- Remove the cup holder tray (4) and then remove the drip tray (6) to empty it.
- Clean the drip tray (6) with a cloth and then re-position it together with the cup holder tray (4).
- Dry components and reassemble in the machine.

#### Cleaning the coffee filters

Clean the coffee filters (13), (14) and (15) regularly under running water. If the holes are clogged, clean them using the needle supplied (19).

#### Cleaning the steam wand (Fig. L)

Clean the steam wand (7) immediately after use.

- Turn the steam knob (8) anti-clockwise to let a little steam out and allow any milk inside to flow out.
- Check that the steam exit hole is not blocked. In the event of any deposits, clean the steam exit hole using the needle supplied (19).

#### Cleaning the dispensing unit

The dispensing unit (2) must be rinsed every 200 coffees made by dispensing approximately 500 ml of water by pressing the coffee keys (20) or (21) without adding ground coffee or a pod.

#### Cleaning the water tank

Clean the water tank (11) approx. once a month using a moist cloth and mild detergent.



## 4.4 Descaling

The coffee machine needs descaling when the orange LED on the key (steam) flashes.

The warning will be displayed every time the machine exits the stand-by status, until the descaling procedure is performed.

Proceed as follows to run the descaling cycle:

- Empty the water tank (11) completely and remove the water softening filter (if present).
- Fill the water tank (11) up to MAX with a solution of water and descaler following the doses recommended by the manufacturer.
- Remove the filter holder (3) and position a container under the dispenser (2) and the steam wand (7).
- Turn the machine on by pressing the ON/OFF button.
- As soon as the machine is ready, hold the key (22) down for 10 seconds until the orange LED has a fixed light.
- Turn the steam knob (8) anti-clockwise.
- Press the key (22) to start descaling, the key (22) starts to flash.
- The descaling cycle automatically performs a series of rinse cycles at intervals to remove lime scale from the inside of the coffee machine, continuing until the tank (11) is empty.
- The descaling cycle stops and the white LED (22) switches on.
- Remove the water tank (11), empty it and rinse it out.
- Fill the tank (11) with water to the maximum level mark and insert it into its housing.
- Position an empty container under the steam wand (7), an empty container under the dispensing unit (2) and check that the steam knob (8) is horizontal.
- Press the steam key (22) again to start the rinse cycle.

- When the tank (11) is empty, it means that the rinse cycle has ended and the machine goes back to ready status.
- Turn the steam knob (8) clockwise.



Personal injury hazard.

- The descaler contains acids that can irritate the skin and eyes.
- Follow the manufacturer's instructions and safety warnings on the packet scrupulously in the event of contact with skin or eyes.
- Use descaler products recommended by Smeg to prevent damage to the coffee machine.



## What to do if...

| <b>Problem</b>  | <b>Possible causes</b>                                       | <b>Solution</b>   |
|---|--|---|
| Coffee does not come out.   | No water in the tank (11). Buttons (20) and (21) flash.      | Fill the tank (11).   |
|   | The filter holes (13-14-15) are blocked.                     | Clean the filter (13-14-15) using the needle supplied (19).                         |
|   | The tank (11) is not inserted correctly.                     | Insert the tank (11) correctly into its housing.                                    |
|   | Lime scale build-up.   | Perform a descaling cycle.  |
| The coffee drips from the filter holder (3) and not from the nozzles.             | The filter holder (3) is not attached correctly or is dirty. | Attach the filter holder (3) and rotate it fully home. Clean the filter holder (3). |
|   | The dispensing unit gasket is worn.                          | Have it replaced at an authorised After-sales Centre.                               |
|   | The nozzle holes are blocked.                                | Clean the nozzle holes.   |
|   | The filter has been overfilled.                              | Introduce the correct quantity into the filter using the measuring scoop supplied.  |
| The filter holder (3) will not attach to the coffee machine.                      | The filter has been overfilled.                              | Use the measuring scoop (12) supplied and use the correct filter.                   |
| The coffee machine does not work and all the LEDs flash.                          | Possible fault.  | Unplug the coffee machine and contact an Authorised After-sales Centre.             |
| The "crema" of the coffee is light in colour and comes out of the nozzle quickly. | The ground coffee has not been tamped sufficiently.          | Tamp the coffee harder.   |
|   | There is insufficient ground coffee.                         | Increase the amount.  |
|   | The ground coffee is too coarse.                             | Use only ground coffee for espresso coffee machines.                                |
|   | Poor quality ground coffee.                                  | Change the type of ground coffee.   |

# What to do if...



| Problem  | Possible causes  | Solution  |
|--|--|---|
| <p>The “crema” of the coffee is dark in colour and comes out of the nozzle slowly.</p> | <p>The ground coffee has not been tamped too hard.</p>           | <p>Tamp the coffee with less force.</p>   |
|  | <p>There is too much ground coffee.</p>                          | <p>Reduce the amount used.</p>  |
|  | <p>The dispensing unit (2) or filter (13-14-15) are blocked.</p> | <p>Clean the dispensing unit (2) and the filter (13-14-15).</p>   |
|  | <p>The ground coffee is too fine.</p>                            | <p>Use only ground coffee for espresso coffee machines.</p>   |
| <p>The LEDs (20) and (21) flash for a few seconds.</p>                                 | <p>Lime scale build-up.</p>                                      | <p>Perform a descaling cycle.</p>   |
|  | <p>Steam knob (8) open.</p>                                      | <p>Turn the steam knob (8) clockwise to close it.</p>   |
|  | <p>High heating element temperature.</p>                         | <p>Cool the heating element as described on page 6.</p>   |
|  | <p>No water in the tank (11).</p>                                | <p>Fill the tank (11).</p>  |
| <p>The coffee is not hot.</p>  | <p>The tank (11) is not inserted correctly.</p>                  | <p>Insert the tank (11) correctly into its housing.</p>   |
|  | <p>Machine not used for a long period of time.</p>               | <p>Increase the temperature of the coffee from the programming menu following that indicated in the “Setting the coffee temperature” paragraph.<br/>Dispense hot water into the cup in which the coffee will be prepared in order to heat the cup, as described in paragraph 3.3.</p> |
| <p>Insufficient frothing.</p>  | <p>The cups have not been pre-heated.</p>                        | <p>Heat cups by rinsing them with hot water (Note: the hot water function can be used).</p>   |
|  | <p>The steam wand is dirty.</p>                                  | <p>Thoroughly clean the steam wand removing the steel nozzle and following the instructions in the manual.<br/>Note: froth quality also depends on the type of milk used and its temperature.</p>   |



## What to do if...

| <b>Problem</b>                       | <b>Possible causes</b>                                      | <b>Solution</b>  |
|--------------------------------------|---|--|
| The machine does not dispense steam. | The steam function was not correctly turned on.             | Follow the instructions in paragraph "Steam dispensing".                       |
|                                      | The machine did not reach the steam dispensing temperature. | Wait until the temperature is reached, indicated by key (22) with fixed light. |
| Steam wand drips during dispensing   | Lime scale build-up.  | Perform a descaling cycle.   |
|                                      | Lime scale build-up   | Perform a de-scaling cycle.  |



Contact local technical support if the problem is not solved or in case of other types of faults.



