

# Table of contents

<b>1</b>	<b>Instructions</b>	<b>4</b>
1.1	General safety instructions	4
1.2	Manufacturer liability	8
1.3	Appliance purpose	9
1.4	Identification plate	9
1.5	This user manual	9
1.6	Disposal	9
1.7	How to read the user manual	10
1.8	To save energy	11
<b>2</b>	<b>Description</b>	<b>12</b>
2.1	General Description	12
2.2	Cooking hob	13
2.3	Control panel	13
2.4	Other parts	14
2.5	Available accessories	15
<b>3</b>	<b>Use</b>	<b>18</b>
3.1	To save energy	20
3.2	Using the accessories	20
3.3	Using the hob	21
3.4	Using the storage compartment	22
3.5	Using the ovens	23
3.6	Programmer clock	26
<b>4</b>	<b>Cleaning and maintenance</b>	<b>32</b>
4.1	Cleaning the surfaces	32
4.2	Cleaning the hob	33
4.3	Cleaning the door	34
4.4	Cleaning the oven cavities	36
4.5	Vapour Clean	37
4.6	Extraordinary maintenance	38
<b>5</b>	<b>Installation</b>	<b>40</b>
5.1	Gas connection	40
5.2	Adaptation to different types of gas	43
5.3	Positioning	48
5.4	Electrical connection	54
5.5	Instructions for the installer	55

## TRANSLATION OF THE ORIGINAL INSTRUCTIONS

We advise you to read this manual carefully, as it contains all the instructions for maintaining the appliance's aesthetic and functional qualities.

For further information on the product: [www.smeg.com](http://www.smeg.com)



## 1 Instructions

### 1.1 General safety instructions

#### Risk of personal injury

- During use the appliance and its accessible parts become very hot. Keep children well away from the appliance.
- Protect your hands by wearing oven gloves when moving food inside the oven.
- Never try to put out a fire or flames with water: turn off the appliance and smother the flames with a fire blanket or other appropriate cover.
- This appliance can be used by children aged from 8 years and above and persons with reduced physical, sensory or mental capabilities or lack of experience and knowledge if they have been given supervision or instruction concerning use of the appliance in a safe way and understand the hazards involved.
- Children must not play with the appliance.
- Keep children under the age of 8 at a safe distance unless they are constantly supervised.
- Keep children under the age of 8 away from the appliance when it is in use.
- Cleaning and maintenance must not be carried out by unsupervised children.
- Make sure that the flame-spreader crowns are correctly positioned in their seats with their respective burner caps.
- Be aware of how rapidly the cooking zones heat up. Do not place empty pans on the heat. Danger of overheating.
- Cooking process should always be kept under control. A short cooking process must be continuously surveyed.
- Fats and oils can catch fire if they overheat. Do not leave the appliance unattended while preparing foods containing oils or fats. If fats or oils catch fire, never put water on them. Place the lid on the pan and turn off the relevant cooking zone.
- While cooking do not place metal objects, such as cutlery or dishes on the hob surface as they may overheat.
- Do not insert pointed metal objects (cutlery or utensils) into the slots in the appliance.
- Do not pour water directly on very hot trays.



- Keep the oven door closed during cooking.
- If you need to move food or at the end of cooking, open the door 5 cm for a few seconds, let the steam come out, then open it fully.
- Do not open the storage compartment (where present) when the oven is on and still hot.
- The items inside the storage compartment could be very hot after using the oven.
- Switch off the appliance after use.
- Do not pull the cable to remove the plug.
- DO NOT USE OR STORE FLAMMABLE MATERIALS IN THE STORAGE COMPARTMENT (IF AVAILABLE) OR NEAR THE APPLIANCE.
- DO NOT USE AEROSOLS IN THE VICINITY OF THIS APPLIANCE WHILST IT IS IN USE.
- DO NOT MODIFY THIS APPLIANCE.
- Before any operation on the appliance (installation, maintenance, positioning or movement) always wear PPM.
- Before performing any operation on the appliance, switch off the power supply.
- Have qualified personnel carry out installation and assistance interventions according to the standards in force.
- Do not try to repair the appliance yourself or without the intervention of a qualified technician.
- In order to avoid hazard, if the power supply cable is damaged, contact technical support and they will replace it.

## **Risk of damaging the appliance**

- Do not use harsh abrasive cleaners or sharp metal scrapers to clean the oven door glass since they can scratch the surface, which may result in shattering of the glass.
- Use wooden or plastic utensils.
- Do not use steam jets to clean the appliance.
- Do not obstruct ventilation openings and heat dispersal slots.



## Instructions

- Do not sit on the appliance.
- Racks and trays should be inserted as far as they will go into the side guides. The mechanical safety locks that prevent them from being removed must face downwards and towards the back of the oven.

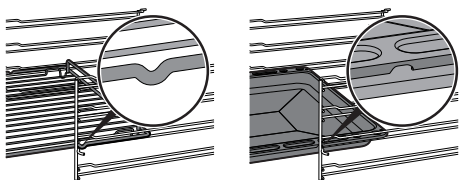

- Never leave the appliance unattended during cooking operations where fats or oils could overheat and take fire. Be very careful
- Danger of fire: do not store items on the cooking surfaces.
- Do not spray any spray products near the oven.
- **DO NOT USE THE APPLIANCE TO HEAT ROOMS FOR ANY REASON.**
- Do not use plastic cookware or containers for cooking.
- Do not place sealed tins or containers in the oven cavity.
- Remove all trays and racks which are not required during cooking.
- Do not cover the bottom of the oven cavity with aluminium or tin foil sheets.
- Do not place pans or trays directly on the bottom of the oven cavity.
- If you wish to use greaseproof paper, place it so that it will not interfere with the hot air circulation inside the oven.
- Do not use the open door to place pans or trays on the internal glazing pane.
- Cooking vessels or griddle plates should be placed inside the perimeter of the hob.
- All pans must have smooth, flat bottoms.
- If any liquid does boil over or spill, remove the excess from the hob.
- Take care not to spill acid substances such as lemon juice or vinegar on the hob.
- Do not use steam jets to clean the appliance.



- Do not put empty pans or frying pans on switched on cooking zones.
- Do not use rough or abrasive materials or sharp metal scrapers.
- Do not use cleaning products containing chlorine, ammonia or bleach on parts made of steel or that have metallic surface finishes (e.g. anodizing, nickel- or chromium-plating).
- Do not wash the removable components such as the hob grids, flame-spreader crowns and burner caps in a dishwasher.
- Never use the oven door to lever the appliance into place when fitting.
- Avoid exerting too much pressure on the door when open.
- Do not use the handle to lift or move this appliance.

## Installation

- THIS APPLIANCE **MUST NOT BE INSTALLED** IN A BOAT OR CARAVAN.
- This appliance must not be installed on a pedestal.
- Position the appliance into the cabinet cut-out with the help of a second person.
- To prevent any possible overheating, the appliance should not be installed behind a decoration door or a panel.
- Before installation, make sure that the local distribution conditions (nature and pressure of the gas) and the adjustment of the appliance are compatible.
- This appliance is not connected to an exhaust system for combustion products. It must be installed and connected in compliance with the current installation regulations. Special attention should be paid to the relevant requirements as for ventilation.



## Instructions

- The adjustment conditions for this appliance are shown on the gas setting label.
- Have the gas connection performed by authorised staff.
- Installation using a hose must be carried out so that the length of the hose does not exceed 2 metres when fully extended for steel hoses and 1.5 metres for rubber hoses.
- The hoses should not come into contact with moving parts and should not be crushed in any way.
- If required, use a pressure regulator that complies with current regulations.
- After carrying out any operation, check that the tightening torque of gas connections is between 10 Nm and 15 Nm.
- At the end of the installation, check for any leaks with a soapy solution, never with a flame.
- Have the electrical connection performed by authorised technicians.
- The appliance must be connected to ground in compliance with electrical

system safety standards.

- Use cables withstanding a temperature of at least 90 °C.
- The tightening torque of the screws of the terminal board leads must be 1.5 - 2 Nm.

### For this appliance

- Ensure that the appliance is switched off before replacing the bulb.
- Do not rest any weight or sit on the open door of the appliance.
- Take care that no objects are stuck in the doors.

### 1.2 Manufacturer liability

The manufacturer declines all liability for damage to persons or property caused by:

- use of the appliance other than that specified;
- failure to comply with the instructions in the user manual;
- tampering with any part of the appliance;
- use of non-original spare parts.



## 1.3 Appliance purpose

- This appliance is intended for cooking food in the home environment. Every other use is considered inappropriate.
- The appliance is not designed to operate with external timers or with remote-control systems.

## 1.4 Identification plate

The identification plate bears the technical data, serial number and brand name of the appliance. Do not remove the identification plate for any reason.

## 1.5 This user manual

This user manual is an integral part of the appliance and must therefore be kept in its entirety and within the user's reach for the whole working life of the appliance.

Read this user manual carefully before using the appliance.

## 1.6 Disposal



This appliance conforms to the WEEE European directive (2012/19/EU) and must be disposed of separately from other waste at the end of its service life.

The appliance does not contain substances in quantities sufficient to be considered hazardous to health and the environment, in accordance with current European directives.

To dispose of the appliance:

- Cut the power supply cable and remove it along with the plug.



**Power voltage**

**Danger of electrocution**

- Disconnect the mains power supply.
- Unplug the appliance.



# Instructions

- Deliver the appliance to the appropriate recycling centre for electrical and electronic equipment waste, or return it to the retailer when purchasing an equivalent product, on a one for one basis.

Our appliances are packaged in non-polluting and recyclable materials.

- Deliver the packing materials to the appropriate recycling centre.



## Plastic packaging Danger of suffocation

- Do not leave the packaging or any part of it unattended.
- Do not let children play with the plastic bags.

## 1.7 How to read the user manual

This user manual uses the following reading conventions:

### Instructions



General information on this user manual, on safety and final disposal.

### Description



Description of the appliance and its accessories.

### Use



Information on the use of the appliance and its accessories.

### Cleaning and maintenance



Information for proper cleaning and maintenance of the appliance.

### Installation



Information for the qualified technician: Installation, operation and inspection.



Safety instructions



Information



Advice

1. Sequence of instructions for use.

- Standalone instruction.





## 1.8 To save energy

- Only preheat the appliance if the recipe requires you to do so.
- Unless otherwise indicated on the package, defrost frozen foods before placing them in the oven.
- When cooking several types of food it is recommended to cook the foods one after the other to make the best use of the already hot oven.
- Use dark metal moulds: They help to absorb the heat better.
- Remove all trays and racks which are not required during cooking.
- Stop cooking a few minutes before the time normally used. Cooking will continue for the remaining minutes with the heat which has accumulated inside the oven.
- Reduce any opening of the door to a minimum to avoid heat dispersal.
- Keep the inside of the oven clean at all times.



# Description

## 2 Description

### 2.1 General Description

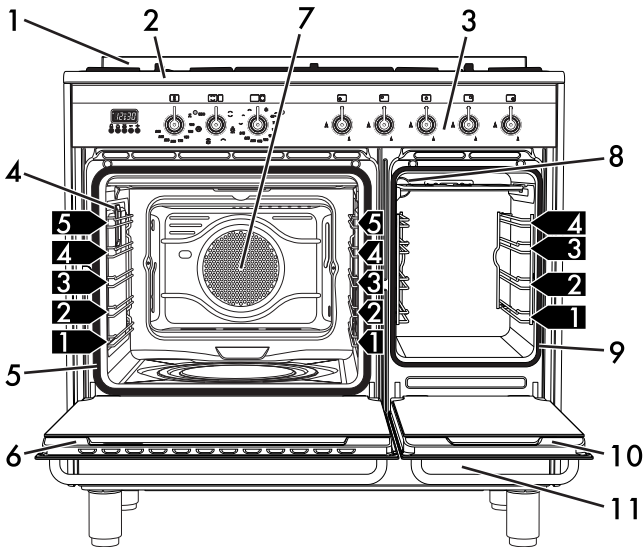
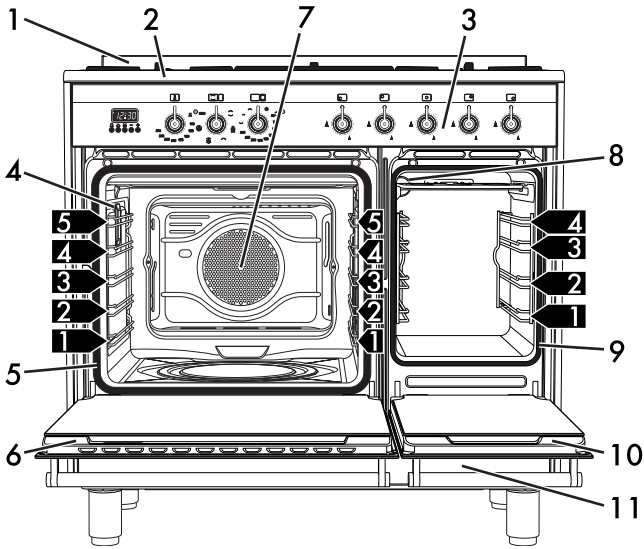



- |                   |  |
|-------------------|--|
| 1 Upstand         | 7 Main oven fan                              |
| 2 Cooking hob     | 8 Auxiliary oven light                       |
| 3 Control panel   | 9 Auxiliary oven seal                        |
| 4 Main oven light | 10 Auxiliary oven door                       |
| 5 Main oven seal  | 11 Storage compartment (on some models only) |
| 6 Main oven door  | <b>1,2,3</b> Rack/tray support frames        |

## 2.2 Cooking hob

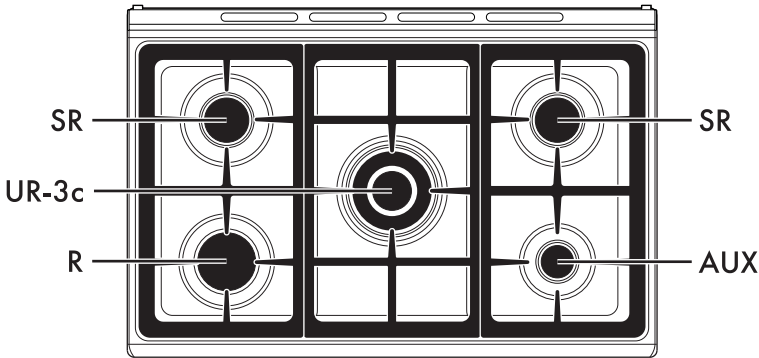

**AUX** = Auxiliary burner  
**SR** = Semi-rapid burner

**R** = Rapid  
**UR-3c** = Ultra-rapid burner

## 2.3 Control panel

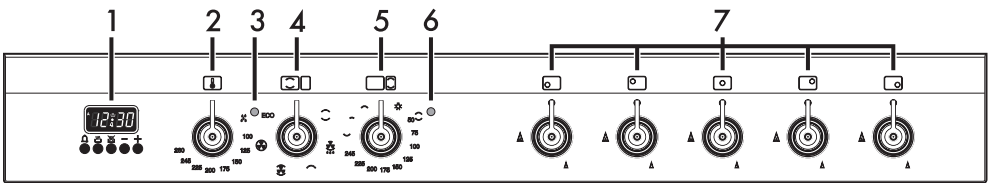

### 1 Programmer clock

Useful for displaying the current time, setting programmed cooking operations and programming the minute minder timer.

### 2 Main oven temperature knob

This knob allows you to select the cooking temperature.

Turn the knob clockwise to the required value, between the minimum and maximum setting.

### 3 Main oven indicator light

The indicator light comes on to indicate that the oven is heating up. It turns off as soon as it reaches the set temperature. It flashes regularly to indicate that the temperature set inside the oven is kept constant.



## Description

### 4 Main oven function knob

The oven's various functions are suitable for different cooking modes. After selecting the required function, set the cooking temperature using the temperature knob.

### 5 Auxiliary oven temperature/function knob





It turns on the light inside the oven or starts the grill and lower heating elements to a temperature ranging from a minimum of 50 °C to a maximum of 245 °C.

At the maximum temperature it is also possible to select some functions optimised for specific cooking types.

### 6 Auxiliary oven indicator light

The indicator light comes on to indicate that the oven is heating up. It turns off as soon as it reaches the set temperature. It flashes regularly to indicate that the temperature set inside the oven is kept constant.

### 7 Hob burner knobs

Used for lighting and adjusting the hob burners. Press and turn the knobs anti-clockwise to  in order to light the relative burners. Turn the knobs to the zone between the maximum  and minimum  setting to adjust the flame. Return the knobs to the position  to turn off the burners.

### 2.4 Other parts

#### Shelves

The appliance features shelves to position trays and racks at different heights. The insertion heights are indicated from the bottom upwards (see 2.1 General Description).

#### Cooling fan

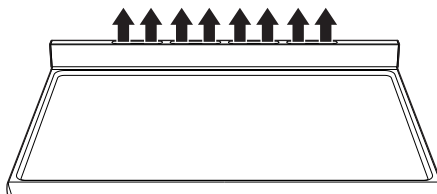

The fan cools the appliance and comes into operation during cooking. The fan causes a steady outflow of air that exits from the rear of the appliance and which may continue for a brief period of time even after the appliance has been turned off.



Do not obstruct ventilation openings and heat dispersal slots.



## Interior lighting

The appliance's interior lighting comes on:  
(main oven)

- when the door is opened;
- when any function is selected, apart from the **ECO** function.

**i** when the door is open, it is not possible to turn off the interior lighting.

## (auxiliary oven)

- when the auxiliary oven temperature/function knob is turned to the  symbol or to any function.

## 2.5 Available accessories

**i** Not all accessories are available on some models.

**i** The oven accessories intended to come into contact with food are made of materials that comply with the provisions of current legislation.

**i** Original supplied and optional accessories can be requested to Authorised Assistance Centres. Use only original accessories supplied by the manufacturer.

### Ring reducer (on some models only)

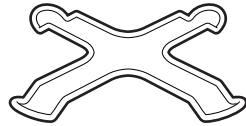

Useful when using small cookware.

### Wok rack (on some models only)

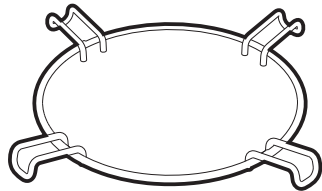

Useful when using a wok.



## Description

### Tray

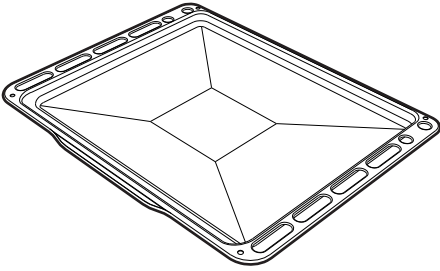

Useful for collecting fat from foods placed on the rack above.

### Deep tray

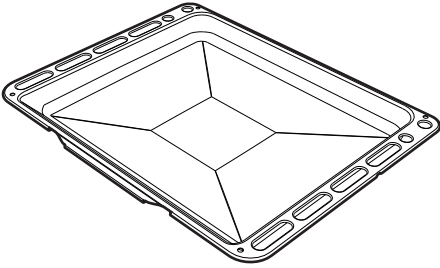

Useful for collecting fat from foods placed on the rack above and for cooking pies, pizzas and baked desserts.

### Tray rack (on some models only)

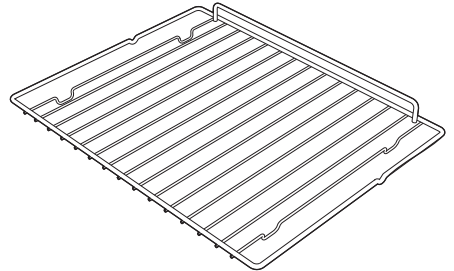
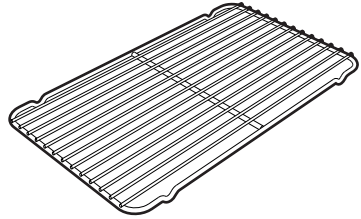
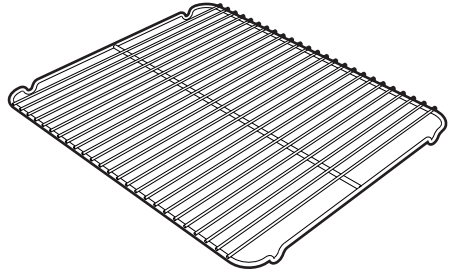

To be placed over the top of the tray; for cooking foods which may drip.



## Rack (on some models only)

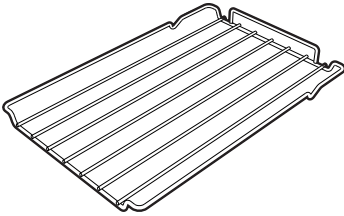
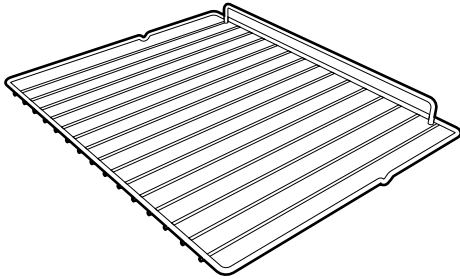

Useful for supporting containers with food during cooking.



## Use

### 3 Use



High temperature inside the oven during use

#### **Danger of burns**

- Keep the oven door closed during cooking.
- Protect your hands wearing heat resistant gloves when moving food inside the oven.
- Do not touch the heating elements inside the oven.
- Do not pour water directly on very hot trays.
- Keep children under the age of 8 away from the oven when it is in use.
- If you need to move food or at the end of cooking, open the door 5 cm for a few seconds, let the steam come out, then open it fully.



Improper use

#### **Danger of burns**

- Make sure that the flame-spreader crowns are correctly positioned in their seats with their respective burner caps.
- Oils and fats could catch fire if overheated. Be very careful.



High temperature inside the storage compartment

#### **Danger of burns**

- Do not open the storage compartment when the appliance is on and still hot.
- The items inside the storage compartment could be very hot after using the appliance.
- It must not be used to store flammable materials, cloths or paper.



Improper use

#### **Risk of damage to surfaces**

- Do not cover the bottom of the oven cavity with aluminium or tin foil sheets.
- If you wish to use greaseproof paper, place it so that it will not interfere with the hot air circulation inside the oven cavity.
- Do not place pans or trays directly on the bottom of the oven cavity.
- Do not use the open door to place pans or trays on the internal glazing pane.
- Do not pour water directly on very hot trays.
- Cooking vessels and griddle plates should be placed inside the perimeter of the hob.
- All pans must have smooth, flat bottoms.
- If any liquid does boil over or spill, remove the excess from the hob.





**High temperature inside the storage compartment**  
**Danger of fire or explosion**

- Do not spray any spray product near the appliance.
- Do not use or leave flammable materials near the appliance or the storage compartment.
- Do not use plastic cookware or containers for cooking.
- Do not place sealed tins or containers in the oven cavity.
- Do not leave the appliance unattended during cooking operations where fats and oils could be released.
- Remove all trays and racks which are not required during cooking.

**A gas leak can cause an explosion.**

If you smell gas or there are faults in the gas system:

- Immediately turn off the gas supply or close the valve on the gas cylinder.
- Extinguish all open flames and cigarettes.
- Do not turn on power switches or appliances and do not remove plugs from power sockets. Do not use phones or mobile phones inside the building.
- Open the window in order to ventilate the room.
- Call customer assistance services or your gas supplier.

**Malfunctions**

Any of the following indicate a malfunction and you should contact a service centre:

- Yellowing of the burner plate.
- Damage to kitchen utensils.
- The burners do not ignite properly.
- It is difficult to keep the burners lit.
- The burners go out when the appliance is in use.
- It is difficult to turn the gas valves.

If the appliance does not work properly, contact your local Authorised Service Centre.

**First use**

1. Remove any protective film from the outside or inside of the appliance, including accessories.
2. Remove any labels (apart from the technical data plate) from the accessories and from the oven cavity.
3. Remove and wash all the appliance's accessories (see 4 Cleaning and maintenance).
4. Heat the empty oven at the maximum temperature to burn off any residues left by the manufacturing process.



## Use

### 3.1 To save energy

- Preheat the appliance only if the recipe requires it.
- Unless differently stated on the package, defrost frozen food before placing it in the cooking compartment.
- In case of multiple cooking, it is recommended to cook food one after the other to exploit the already hot cooking compartment.
- Use dark metal moulds: They help to absorb the heat better.
- Remove all trays and racks which are not required during cooking.
- Stop cooking a few minutes before the time normally used. Cooking will continue for the remaining minutes with the heat which has accumulated inside the oven.
- Reduce any opening of the door to a minimum to avoid heat dispersal.
- Keep the cooking compartment clean at all times.

### 3.2 Using the accessories

#### Ring reducers

The ring reducers must be placed on the hob grids. Make sure they are placed properly.

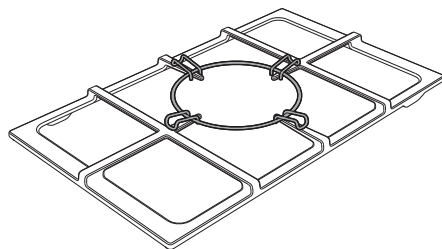
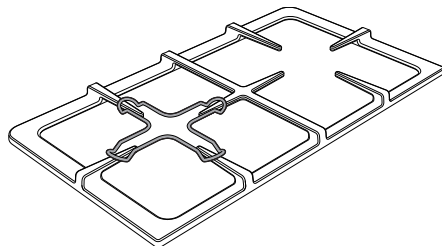

#### Tray rack

The tray rack has to be inserted into the tray. In this way fat can be collected separately from the food which is being cooked.

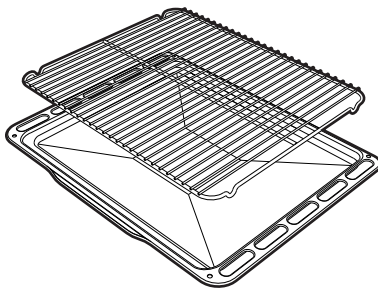



## Racks and trays

Racks and trays have to be inserted into the side guides until they come to a complete stop.

- The mechanical safety locks that prevent the rack from being taken out accidentally have to face downwards and towards the oven back.

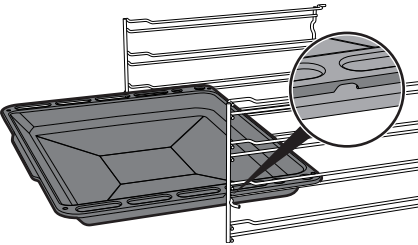
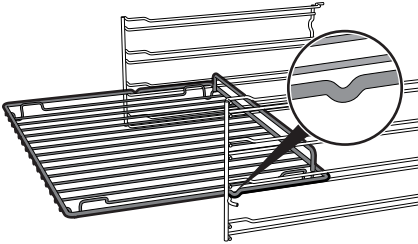

Gently insert racks and trays into the oven until they come to a stop.



Clean the trays before using them for the first time to remove any residues left by the manufacturing process.

## 3.3 Using the hob

All the appliance's control and monitoring devices are located together on the front panel. The burner controlled by each knob is shown next to the knob. The appliance is equipped with an electronic ignition device. Simply press the knob and turn it counterclockwise to the maximum flame symbol, until the burner ignites. If the burner does not light in the first 15 seconds, turn the knob to  and wait 60 seconds before trying again. After lighting, keep the knob pressed in for a few seconds to allow the thermocouple to heat up. The burner may go out when the knob is released: In this case, the thermocouple has not heated up sufficiently.

Wait a few moments and repeat the operation. Keep the knob pressed in longer.



In case of an accidental switching off, a safety device will be tripped, cutting off the gas supply, even if the gas cock is open. Return the knob to  and wait at least 60 seconds before lighting it again.



## Correct positioning of the flame-spreader crowns and burner caps

Before lighting the hob burners, make sure that the flame-spreader crowns are correctly positioned in their seats with their respective burner caps. Make sure that the holes **1** in the flame-spreader crowns are aligned with the igniters **3** and thermocouples **2**.

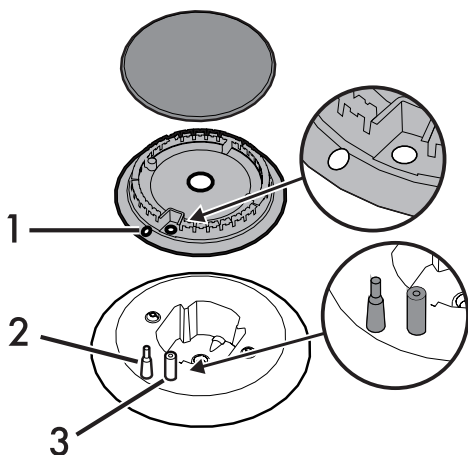

## Practical tips for using the hob

For better burner efficiency and to minimise gas consumption, use pans with lids and of suitable size for the burner, so that the flames do not reach up the sides of the pan.

Once the contents come to the boil, turn down the flame far enough to ensure that the liquid does not boil over.



Pan diameters:

- **AUX:** 12 - 14 cm.
- **SR:** 16 - 24 cm.
- **R:** 18 - 26 cm.
- **UR-3c:** 18 - 28 cm.

## 3.4 Using the storage compartment

The storage compartment is at the bottom of the cooker. To open it, pull the handle towards you. It can be used to store cookware or metallic objects necessary when using the appliance.

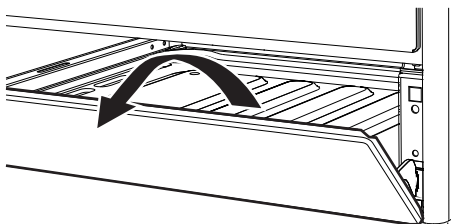



## 3.5 Using the ovens



### Switching on the main oven



1. Select the cooking function using the function knob.
2. Select the temperature using the temperature knob.



Ensure that the programmer clock shows the cooking duration symbol , otherwise it will not be possible to turn on the oven.

Press the keys  and  at the same time to reset the programmer clock.

### Main oven functions



#### Static

As the heat comes from above and below at the same time, this system is particularly suitable for certain types of food. Traditional cooking, also known as static cooking, is suitable for cooking just one dish at a time. Perfect for all types of roasts, bread and cakes, and in any case, particularly suitable for fatty meats such as goose and duck.



#### Fan + lower element

The combination of the fan with just the lower heating element allows cooking to be completed more rapidly. This system is recommended for sterilising or for finishing off the cooking of foods which are already well-cooked on the surface, but not inside, which therefore need a little more heat. Perfect for any type of food.



#### Grill

The heat coming from the grill element gives perfect grilling results above all for thin and medium thickness meat and, in combination with the rotisserie (where fitted), gives the food an even browning at the end of cooking. Perfect for sausages, spare ribs and bacon. This function enables large quantities of food, particularly meat, to be grilled evenly.



#### Fan assisted

The operation of the fan, combined with traditional cooking, ensures consistent cooking even with complex recipes. Perfect for biscuits and cakes, even when simultaneously cooked on several levels. (For multiple-level cooking, we recommend using the 2nd and 4th runners).



## Use



### Fan with round heating element

The combination of the fan and the round heating element (incorporated in the rear of the oven) allows you to cook different foods on several levels, as long as they need the same temperatures and same type of cooking. Hot air circulation ensures instant and even distribution of heat. It will be possible, for instance, to cook fish, vegetables and biscuits simultaneously (on different levels) without odours and flavours mingling.

### ECO

#### Eco

This function is particularly suitable for cooking on a single shelf with low energy consumption.

It is recommended for all types of food, excluding those that can create a lot of humidity (such as vegetables).

To obtain maximum energy savings and reduce cooking times, it is recommended to place food in the oven without preheating.



When using the ECO function, avoid opening the door during cooking.



Cooking (and preheating) times are longer with the ECO function.



The ECO function is a delicate cooking function and is recommended for food withstanding temperatures lower than 210 °C; in case of cooking at higher temperatures, select another function.



### Vapour Clean

This function makes cleaning easier using the steam produced by a little quantity of water poured onto the appropriate groove placed on the bottom. (see chapter "Cleaning and maintenance")

### Switching on the auxiliary oven



Turn the temperature/function knob to the required temperature, from a minimum of 50 °C to a maximum of 245 °C, or to the required function (at the maximum temperature).

### Auxiliary oven functions



#### Light bulb

Turns on the light inside the oven cavity.



### Static (min 50 °C - max 245 °C)

As the heat comes from above and below at the same time, this system is particularly suitable for certain types of food. Traditional cooking, also known as static cooking, is suitable for cooking just one dish at a time. Perfect for all types of roasts, bread and cakes, and in any case, particularly suitable for fatty meats such as goose and duck.



### Lower heating element (245 °C)

The heat coming just from the bottom allows you to complete the cooking of foods that require a higher bottom temperature, without affecting their browning. Perfect for cakes, pies, tarts and pizzas.



### Small grill (245 °C)

Using only the heat released from the central element, this function allows you to grill small portions of meat and fish for making kebabs, toasted sandwiches and any types of grilled vegetable side dishes.



### Grill

The heat coming from the grill element gives perfect grilling results above all for thin and medium thickness meat and allows you to give the food an even browning at the end of the cooking. Perfect for sausages, spare ribs and bacon. This function enables large quantities of food, particularly meat, to be grilled evenly.

## General advice

- Use a fan assisted function to achieve consistent cooking at several levels.
- It is not possible to shorten cooking times by increasing the temperature (the food could be overcooked on the outside and undercooked on the inside).
- For the same total weight, cooking time will be greater for cooking a whole piece than when it is cut into smaller pieces.

## Advice for cooking meat

- Cooking times vary according to the thickness and quality of the food and to consumer taste.
- Use a meat thermometer when roasting meat, or simply press on the roast with a spoon. If it is hard, it is ready; If not, it needs another few minutes cooking.

## Advice for cooking with the Grill

- Meat can be grilled even when it is put into the cold oven or into the preheated oven if you wish to change the effect of the cooking.
- When using the Fan with grill function, we recommend that you preheat the oven before grilling.
- We recommend placing the food at the centre of the rack.
- With the Grill function, we recommend that you turn the temperature knob to the maximum value to optimise cooking.



## Use

### Advice for cooking desserts/pastries and biscuits

- Use dark metal moulds: They help to absorb the heat better.
- The temperature and the cooking time depend on the quality and consistency of the dough.
- When cooking on multiple levels, food should ideally be positioned on the second and fourth shelves; increase cooking time by a few minutes and only used fan functions.
- To check whether the dessert is cooked right through: At the end of the cooking time, put a toothpick into the highest point of the dessert. If the dough does not stick to the toothpick, the dessert is cooked.
- If the dessert collapses when it comes out of the oven, on the next occasion reduce the set temperature by about 10 °C, selecting a longer cooking time if necessary.
- The cooking time for meringues and choux pastry will vary depending on the size.

### Advice for defrosting and proving

- Place frozen foods without their packaging in a lidless container on the first shelf of the oven.
- Avoid overlapping the food.
- To defrost meat, use the rack placed on the second level and a tray on the first level. In this way, the liquid from the defrosting food drains away from the food.

- Bread and fruit, if divided into pieces, will take the same amount of time to defrost, regardless of the total weight and quantity.
- The most delicate parts can be covered with aluminium foil.
- For successful proving, a container of water should be placed in the bottom of the oven.

### 3.6 Programmer clock

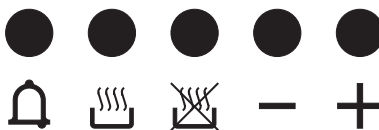

 Minute minder timer key

 Cooking duration key

 End of cooking key.

 Decrease key

 Increase key





The programmer clock only controls the main oven and does not control the auxiliary oven.











**i** Ensure that the programmer clock shows the cooking duration symbol , otherwise it will not be possible to turn on the oven.

Press the keys  and  at the same time to reset the programmer clock.

### Setting the time









**i** If the time is not set, the oven will not switch on.

On the first use, or after a power failure, the digits  will be flashing on the appliance's display.

1. Press the keys  and  at the same time. The dot between the hours and the minutes flashes.
2. The time can be set using the key  or . Keep the key pressed in to increase or decrease rapidly.
3. Press the key  or wait 5 seconds. The dot between the hours and the minutes stops flashing.
4. The symbol  on the display indicates that the appliance is ready to start cooking.

### Timed cooking

**i** Timed cooking is the function which allows a cooking operation to be started and then ended after a specific length of time set by the user.

1. After selecting a cooking function and temperature, press the  key. The display will show the digits  and the symbol  displayed between the hours and the minutes.
2. Use the  or  key to set the required minutes.
3. Wait approx. 5 seconds without pressing any key in order for the function to activate. The current time and the symbols **A** and  will appear on the display.
4. At the end of cooking the heating elements will be deactivated. On the display, the symbol  turns off, the symbol **A** flashes and the buzzer sounds.
5. To turn off the buzzer just press any key of the programmer clock.
6. Press the keys  and  at the same time to reset the programmer clock.

 It is not possible to set a cooking time of more than 10 hours.





## Use



After the setting, to display the cooking time left press the  key.











To reset the set program, press the keys  and  at the same time and switch off the oven manually.

### Programmed cooking





Programmed cooking is the function which allows a cooking operation to be started at a set time and then ended after a specific length of time set by the user.

1. Set the cooking time as described in the previous point "Timed cooking".
2. Press the  key. The sum of the current time plus the pre-set cooking duration will appear on the display.
3. Use the  or  key to set the required minutes.
4. Wait approx. 5 seconds without pressing any key in order for the function to activate. The current time and the symbols  and  will appear on the display.

5. At the end of cooking the heating elements will be deactivated. On the display, the symbol  turns off, the symbol  flashes and the buzzer sounds.
6. To turn off the buzzer just press any key of the programmer clock.
7. Press the keys  and  at the same time to reset the programmer clock.





After the setting, to display the cooking time left press the  key. To display the end of cooking time, press the  key.

### Adjusting the buzzer volume

The buzzer volume can be set to 3 different levels. When the buzzer is in operation, press the  key to change the setting.

### Deleting the set data

Press the keys  and  at the same time to reset the programs set. Then switch off the oven manually if cooking is in progress.









## Minute minder timer



The minute minder timer does not stop the cooking operation but rather informs the user when the set time has run out.

The minute minder timer can be activated at any time.

1. Press the  key. The display shows the digits  and the indicator light  flashing between the hours and the minutes.
2. Use the  or  key to set the required minutes.
3. Wait approx. 5 seconds without pressing any key to finish setting the minute minder. The current time and the symbols  and  appear on the display.



It is not possible to set a cooking time of more than 24 hours.



After the minute minder timer has been programmed, the display will go back to showing the current time. Press the  key to display the remaining time.



# Use

## Main oven cooking information table

Food	Weight (kg)	Function	Shelf	Temperature (°C)	Time (minutes)	
Lasagne	3 - 4	Static	1	220 - 230	45 - 50	
Pasta bake	3 - 4	Static	1	220 - 230	45 - 50	
Roasted veal	2	Turbo/Round	2	180 - 190	90 - 100	
Pork loin	2	Turbo/Round	2	180 - 190	70 - 80	
Sausages	1.5	Fan with grill	4	260	15	
Roast beef	1	Turbo/Round	2	200	40 - 45	
Roast rabbit	1.5	Round	2	180 - 190	70 - 80	
Turkey breast	3	Turbo/Round	2	180 - 190	110 - 120	
Roast pork neck	2 - 3	Turbo/Round	2	180 - 190	170 - 180	
Roast chicken	1.2	Turbo/Round	2	180 - 190	65 - 70	
					1 <sup>nd</sup> surface	2 <sup>nd</sup> surface
Pork chops	1.5	Fan with grill	4	260	15	5
Spare ribs	1.5	Fan with grill	4	260	10	10
Bacon	0.7	Grill	5	260	7	8
Pork fillet	1.5	Fan with grill	4	260	10	5
Beef fillet	1	Grill	5	260	10	7
Salmon trout	1.2	Turbo/Round	2	150 - 160	35 - 40	
Delicate fish	1.5	Turbo/Round	2	160	60 - 65	
Flounder	1.5	Turbo/Round	2	160	45 - 50	
Pizza	1	Turbo/Round	2	260	8 - 9	
Bread	1	Round	2	190 - 200	25 - 30	
Focaccia	1	Turbo/Round	2	180 - 190	20 - 25	
Ring cake	1	Round	2	160	55 - 60	
Tart	1	Round	2	160	35 - 40	
Ricotta cake	1	Round	2	160 - 170	55 - 60	
Jam tarts	1	Turbo/Round	2	160	20 - 25	
Chiffon cake	1.2	Round	2	160	55 - 60	
Profiteroles	1.2	Turbo/Round	2	180	80 - 90	
Sponge cake	1	Round	2	150 - 160	55 - 60	
Rice pudding	1	Turbo/Round	2	160	55 - 60	
Brioches	0.6	Round	2	160	30 - 35	



## Auxiliary oven cooking information table

Food	Weight (kg)	Function	Shelf	Temperature (°C)	Time (minutes)	
Roast rabbit	1	Static	2	190 - 200	85 - 90	
Roast chicken	1	Static	2	190 - 200	80 - 85	
					1 <sup>nd</sup> surface	2 <sup>nd</sup> surface
Chops	0.8	Grill	4	250	13	5
Hamburgers	0.6	Grill	4	250	7	3
Pork sausages	0.6	Grill	4	250	15	-
Pork spare ribs	0.7	Grill	4	250	30 -	-
Bacon	0.6	Grill	4	250	10	3

The times indicated in the table do not include preheating times and are provided only as a guide.



## 4 Cleaning and maintenance



**Improper use**

**Risk of damage to surfaces**

- Do not use steam jets to clean the appliance.
- Do not use cleaning products containing chlorine, ammonia or bleach on parts made of steel or that have metallic surface finishes (e.g. anodizing, nickel- or chromium-plating).
- Do not use abrasive or corrosive detergents (e.g. scouring powders, stain removers and metallic sponges) on glass parts.
- Do not use rough or abrasive materials or sharp metal scrapers.
- Do not wash the removable components such as the hob grids, flame-spreader crowns and burner caps in a dishwasher.



We recommend the use of cleaning products distributed by the manufacturer.

### Ordinary daily cleaning

Always use specific products only that do not contain abrasives or chlorine-based acids.

Pour the product onto a damp cloth and wipe the surface, rinse thoroughly and dry with a soft cloth or a microfibre cloth.

### Food stains or residues

Do not use steel sponges and sharp scrapers, as they will damage the surfaces.

Use normal, non-abrasive products and a wooden or plastic tool, if necessary. Rinse thoroughly and dry with a soft cloth or a microfibre cloth.

Do not allow residues of sugary foods (such as jam) to set inside the oven. If left to set for too long, they might damage the enamel lining of the oven.



After cleaning, dry the appliance thoroughly to prevent water or detergent drips from interfering with its operation or creating unsightly marks.

### 4.1 Cleaning the surfaces

To keep the surfaces in good condition, they should be cleaned regularly after use. Let them cool first.



## 4.2 Cleaning the hob

### Cooking hob grids

Remove the grids and clean them in lukewarm water and non-abrasive detergent. Make sure to remove any encrustations. Dry them thoroughly and return them to the hob.



The continuous contact between the grids and the flame can cause modifications to the enamel over time in those parts exposed to heat. This is a completely natural phenomenon which has no effect on the operation of this component.

### Flame-spreader crowns and burner caps

For easier cleaning, the flame-spreader crowns and the burner caps can be removed. Wash them in hot water and non-abrasive detergent. Carefully remove any encrustation, then wait until they are perfectly dry. Refit the flame-spreader crowns making sure that they are correctly positioned in their housings with their respective burner caps.

### Igniters and thermocouples

For correct operation the igniters and thermocouples must always be perfectly clean. Check them frequently and clean them with a damp cloth if necessary. Remove any dry residues with a wooden toothpick or a needle.

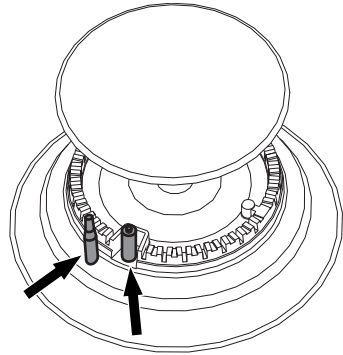

### Knobs



Do not use aggressive products containing alcohol or products for cleaning steel and glass when cleaning the knobs, as these products could cause permanent damage.

The knobs should be cleaned with a soft cloth dampened with warm water, then dried carefully. They can be removed by pulling them out of their housing.



## Cleaning and maintenance

### 4.3 Cleaning the door

#### Removing the door

For easier cleaning, the door can be removed and placed on a towel.

To remove the door proceed as follows:

1. Open the door completely and insert two pins into the holes on the hinges indicated in the figure.

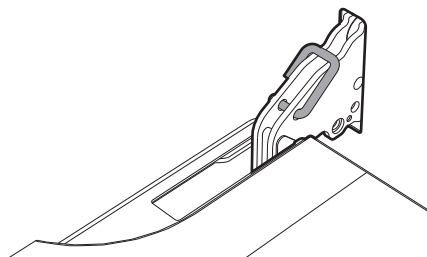

2. Grasp the door on both sides with both hands, lift it forming an angle of around 30° and remove it.

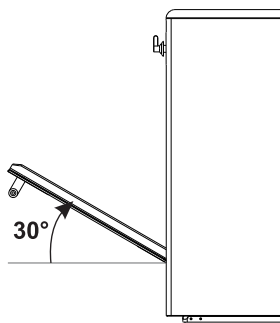

3. To reassemble the door, put the hinges in the relevant slots in the oven, making sure that grooved sections **A** are resting completely in the slots. Lower the door and once it is in position, remove the pins from the holes in the hinges.

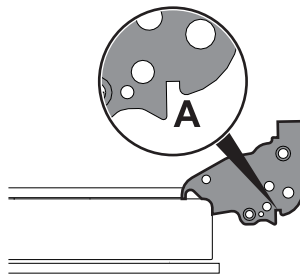

#### Cleaning the door glazing

The door glazing should always be kept thoroughly clean. Use absorbent kitchen roll. In case of stubborn dirt, wash with a damp sponge and an ordinary detergent.





## Removing the internal glass panes

For easier cleaning, the internal glass panes of the door can be removed.

1. Remove the internal glass pane by pulling the rear part gently upwards following the movement indicated by the arrows (1). This way, the 4 pins attached to the glass detach from their housings in the door.
2. Then, pull the front part upwards (2).

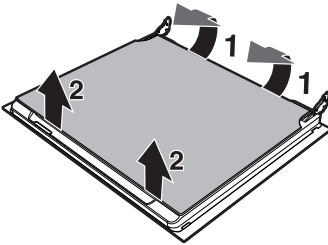

3. Remove the intermediate glazing pane by lifting it upwards. Proceed in the same way for the internal glazing pane, but push the front part of the pane (2) towards the inside of the appliance.

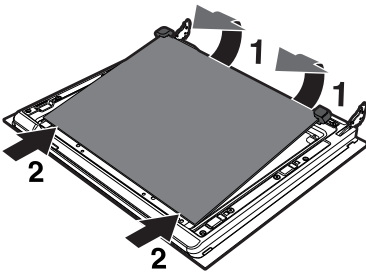

4. Clean the external glass pane and the previously removed panes. Use absorbent kitchen roll. In case of stubborn dirt, wash with a damp sponge and neutral detergent.

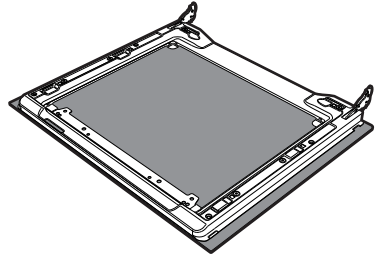

5. Refit the panes in the reverse order of removal.
6. Reposition the internal glass pane. Take care to centre and insert the 4 pins into their housings in the oven door by applying slight pressure.

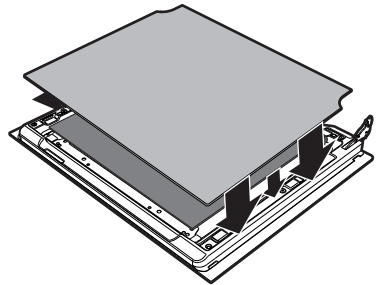



## Cleaning and maintenance

### 4.4 Cleaning the oven cavities

For the best oven cavities upkeep, clean them regularly after having allowed them to cool.

Avoid letting food residue dry inside the oven cavities, as this could damage the enamel.

Take out all removable parts.

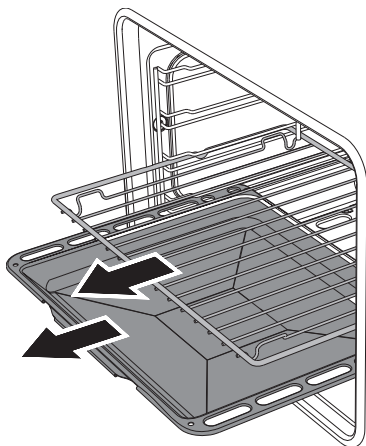

### Removing racks/trays support frames

Removing the guide frames enables the sides to be cleaned more easily. This operation should be performed each time the automatic cleaning cycle is used (on some models only).

To remove the guide frames. Pull the frame towards the inside of the oven to unhook it from its groove **A**, then slide it out of the seats **B** at the back.

When cleaning is complete, repeat the above procedures to put the guide frames back in.

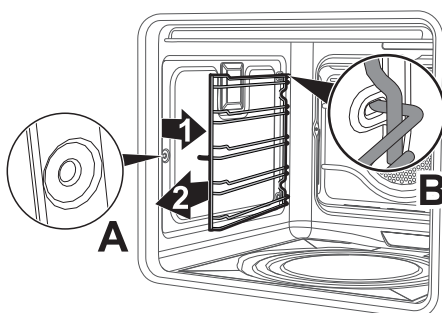

For easier cleaning, it is recommended to remove:

- the door
- the rack/tray support frames
- the oven gasket



The oven should be operated at the maximum temperature for about 15-20 minutes after the use of specific products, to burn off the residues left inside the oven.



## 4.5 Vapour Clean



Vapor Clean is an assisted cleaning procedure which facilitates the removal of dirt. Thanks to this process, it is possible to clean the inside of the main oven very easily. The dirt residues are softened by the heat and water vapour for easier removal afterwards.

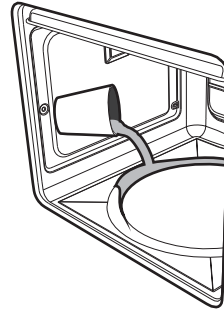

### Improper use Risk of damage to surfaces

- Remove any food residues or large spills from previous cooking operations from the inside of the oven.
- Carry out assisted oven cleaning operations only when the oven is cold.

- Spray a water and washing up liquid solution inside the oven using a spray nozzle. Direct the spray against the side walls, upwards, downwards and towards the deflector.

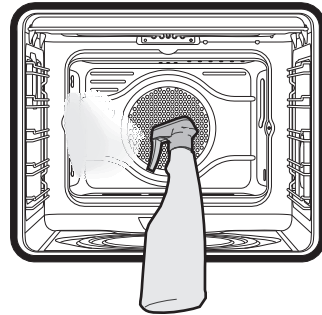

### Preliminary operations

Before starting the Vapor Clean cycle:

- Remove all accessories from inside the oven cavity.
- Pour approx. 40 cc of water onto the floor of the oven. Make sure it does not overflow out of the cavity.





We recommend spraying approx. 20 times at the most.

- Close the door.



# Cleaning and maintenance

## Vapor Clean cycle setting

1. Turn the function knob to the symbol  and the temperature knob to the symbol .
2. Set a cooking time of 18 minutes using the digital programmer.
3. Turn the function knob to the  symbol and the temperature knob to the **0** symbol.

## End of the Vapor Clean cycle

4. Open the door and wipe away the less stubborn dirt with a microfibre cloth.
5. Use a non-scratch sponge with brass filaments on hard to remove deposits.
6. In case of grease residues use specific oven cleaning products.
7. Remove the water left inside the oven.

For improved hygiene and to avoid food being affected by any unpleasant odours, we recommend that the oven is dried using a fan assisted function at 160 °C for approximately 10 minutes.



We recommend wearing rubber gloves for these operations.



For easier manual cleaning of parts that are difficult to reach, we recommend removing the door.

## 4.6 Extraordinary maintenance

### Replacing the interior light bulb (main oven)



Live parts  
**Danger of electrocution**

- Unplug the appliance from the mains.
1. Remove all accessories from inside the oven cavity.
  2. Remove the rack/tray support frames.
  3. Remove the bulb cover using a tool (e.g. a screwdriver).



Take care not to scratch the enamel of the oven cavity wall.

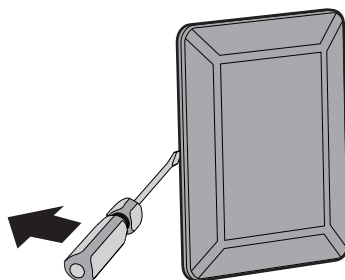



4. Slide out and remove the light bulb.

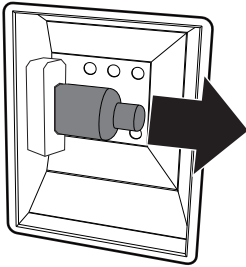

Do not touch the halogen light bulb directly with your fingers, use an insulating material.

5. Replace the light bulb with one of the same type (40W).
6. Refit the cover. Ensure the moulded part of the glass (**A**) is facing the door.

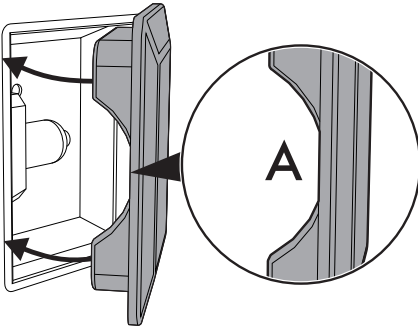

7. Press the cover down as far as it will go so that it attaches completely to the bulb support.

## Replacing the interior light bulb (auxiliary oven)

1. Unscrew bulb protector **A** (turn anti-clockwise).
2. Replace bulb **B** with one of the same type (25W). Use only oven bulbs (T 300 °C).

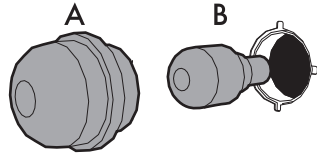

3. Re-fit bulb protector **A**.

## Installing and removing the seal

To remove the seal:

- Unhook the clips in the 4 corners then pull the seal outwards.

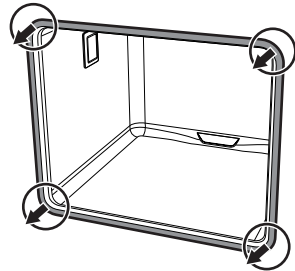

To refit the seal:

- Hook the clips in the 4 corners onto the seal.

## Seal maintenance tips

The seal should be soft and elastic.

- To keep the seal clean, use a non-abrasive sponge and wash with lukewarm water.



# Installation

## 5 Installation

### 5.1 Gas connection



**Gas leak  
Danger of explosion**

- After carrying out any operation, check that the tightening torque of gas connections is between 10 Nm and 15 Nm.
- If required, use a pressure regulator that complies with current regulations.
- At the end of the installation, check for any leaks with a soapy solution, never with a flame.
- Installation using a hose must be carried out so that the length of the hose does not exceed 2 metres when fully extended for steel hoses and 1.5 metres for rubber hoses.
- The hoses should not come into contact with moving parts and should not be crushed in any way.

### General information

Connection to the gas mains can be made using a continuous wall steel hose in compliance with the guidelines established by the standards in force. The appliance is preset for natural gas G20 (2H) at a pressure of 20 mbar. For supplying it with other types of gas, see chapter "5.2 Adaptation to different types of gas". The gas inlet connection is threaded 1/2" external gas (ISO 228-1).

### Connection with a rubber hose

Verify that all following conditions are met:

- the hose is attached to the hose connector with safety clamps;
- no part of the hose is in contact with hot walls (max. 50 °C);
- the hose is not under traction or tension and has no kinks or twists;
- the hose is not in contact with sharp objects or sharp corners;
- if the hose is not perfectly airtight and leaks gas, do not try to repair it; replace it with a new hose;
- verify that the hose is not past its expiry date (serigraphed on the hose itself).

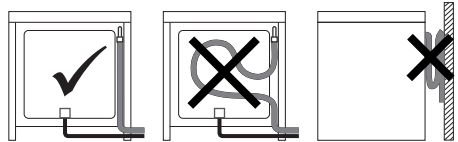

Make the connection to the gas mains using a rubber hose whose specifications comply with current standards (verify that the reference standard is stamped on the hose).



Carefully screw the hose connector **3** to the appliance's gas connector **1** ( $\frac{1}{2}$ " thread ISO 228-1), placing the seal **2** between them. The hose connector **4** can also be screwed to the hose connector **3**, depending on the diameter of the gas hose used. After having tightened the hose connector(s), push the gas hose **6** onto the hose connector and secure it with the clamp **5** that is compliant with the standard in force.

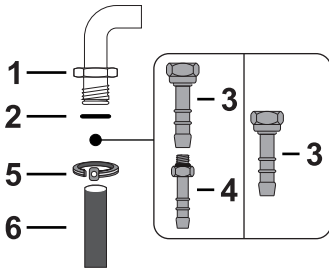

Connection using a rubber hose complying with current standards is only permitted if the hose can be inspected along its entire length.



The inside diameter of the hose must be 8 mm for LPG and 13 mm for Natural gas and Town gas.

## Connection with a steel hose

Make the connection to the gas mains using a continuous wall steel hose whose specifications comply with the applicable standard.

Carefully screw the connector **3** to the gas connector **1** of the appliance, placing the seal **2** between them.

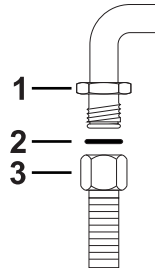

## Connection with a steel hose with bayonet fitting

Carry out the connection to the gas mains using a steel hose with bayonet fitting compliant with B.S. 669. Apply insulating material to the thread of the gas hose connector **4** and then tighten the adapter **3**. Screw the assembly to the movable connector **1** of the appliance, placing the supplied seal **2** between them.

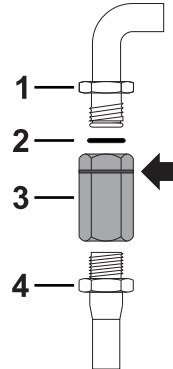



# Installation

## Connection to LPG

Use a pressure regulator and make the connection on the gas cylinder following the guidelines set out in the standards in force.

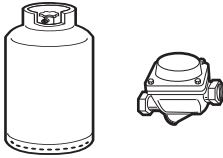

The supply pressure must comply with the values indicated in the table "Gas types and Countries".

## Connection with a steel hose with conical fitting

Make the connection to the gas mains using a continuous wall steel hose whose specifications comply with the applicable standard.

Carefully screw the hose connector **3** to the appliance's gas connector **1** ( $\frac{1}{2}$ " thread ISO 228-1), placing the supplied seal **2** between them. Apply insulating material to the thread of connector **3**, then tighten the steel hose **4** to the connector **3**.

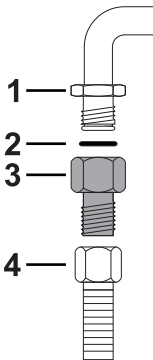

## Room ventilation

The appliance should be installed in rooms that have a permanent air supply in accordance with the standards in force. The room where the appliance is installed must have enough air flow for the regular combustion of gas and the necessary air change in the room itself. The air vents, protected by grilles, must be the right size to comply with current regulations and positioned so that no part of them is obstructed, not even partially.

The room must be kept adequately ventilated in order to eliminate the heat and humidity produced by cooking: In particular, after prolonged use, you are recommended to open a window or to increase the speed of any fans.

## Extraction of the combustion products



This appliance is not connected to an exhaust system for combustion products. It must be installed and connected in compliance with the current installation regulations. Special attention should be paid to the relevant requirements as for ventilation.

The combustion products may be extracted by means of hoods connected to a natural draught chimney whose efficiency is certain or via forced extraction.





An efficient extraction system requires precision planning by a specialist qualified in this area and must comply with the positions and clearances indicated by the applicable standards.

When the job is complete, the installer must issue a certificate of conformity.

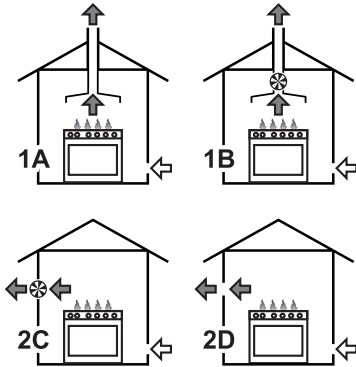

- 1 Extraction using a hood
- 2 Extraction without a hood

- A Single natural draught chimney
- B Single chimney with extractor fan
- C Directly outdoors with wall- or window-mounted extractor fan
- D Directly outdoors through wall

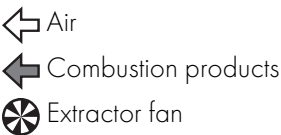

## 5.2 Adaptation to different types of gas

**i** The appliance is preset for natural gas G20 at a pressure of 20 mbar.

In case of operation with other types of gas, the burner nozzles must be changed and the minimum flame adjusted on the gas taps.

### Replacing nozzles

1. Remove the grids, burner caps and flame-spreader crowns in order to access the burner cups.

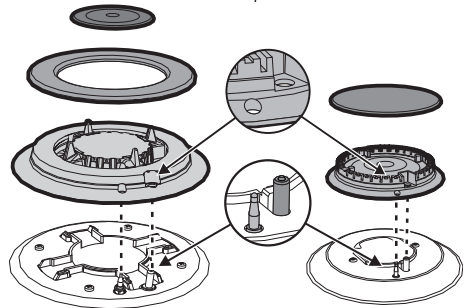

2. Replace the nozzles using a 7-mm socket wrench according to the gas to be used (see "Nozzle and burner specification tables").

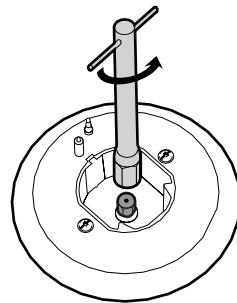

3. Reposition the burners in their respective housings.



# Installation

## Adjusting the minimum setting for natural or town gas

Light the burner and turn it to the minimum position. Remove the gas tap knob and turn the adjustment screw next to the tap rod (depending on the model) until the correct minimum flame is obtained.

Refit the knob and verify that the burner flame is stable. Turn the knob rapidly from the maximum to the minimum setting: The flame should not go out. Repeat the operation on all gas cocks.

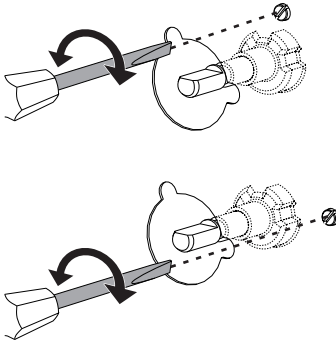

## Adjusting the minimum setting for LPG

Tighten the screw located at the side of the cock rod clockwise all the way.



Following adjustment to a gas other than the one originally set in the factory, replace the gas setting label on the appliance with the one corresponding to the new gas. The label is inserted inside the nozzle pack (where present).

## Lubricating the gas taps

Over time the gas taps may become difficult to turn and get blocked. Clean them internally and replace the lubrication grease.



Lubrication of the gas cocks should be performed by a specialised technician.



## Gas types and Countries

Gas types		IT	GB-IE	FR-BE	DE	AT	NL	ES	PT	RU	SE-DKFI-NO	PL	HU
<b>1 Natural gas G20</b>													
G20	20 mbar	•	•	•	•	•	•	•	•	•	•	•	
G20/25	20/25 mbar		•										
<b>2 Natural gas G20</b>													
G20	25 mbar												•
<b>3 Natural gas G25</b>													
G25	25 mbar						•						
G25.3	25 mbar						•						
<b>4 Natural gas G25.1</b>													
G25.1	25 mbar												•
<b>5 Natural gas G25</b>													
G25	20 mbar				•								
<b>6 Natural gas G2.350</b>													
G2.350	13 mbar												•
<b>7 LPG G30/31</b>													
G30/31	28-30/37 mbar	•	•					•	•	•			
G30/31	30/30 mbar			•			•				•	•	•
<b>8 LPG G30/31</b>													
G30/31	37 mbar												
<b>9 LPG G30/31</b>													
G30/31	50 mbar				•	•							
<b>10 Town gas G110</b>													
G110	8 mbar	•									•		



It is possible to identify the available gas types based on the country the appliance is to be installed in. Refer to the heading number to identify the correct values in the "Burner and nozzle specifications tables".



# Installation

## Burner and nozzle specifications tables

<b>1 Natural gas G20</b>	<b>AUX</b>	<b>SR</b>	<b>R</b>	<b>UR-3c</b>
Rated heating capacity (kW)	1.0	1.8	2.9	4.0
Nozzle diameter (1/100 mm)	72	94	115	145
Pre-chamber (printed on nozzle)	(X)	(Y)	(Y)	(Z)
Reduced flow rate (W)	400	500	800	1600
<b>2 Natural gas G20</b>	<b>AUX</b>	<b>SR</b>	<b>R</b>	<b>UR-3c</b>
Rated heating capacity (kW)	1.1	1.8	2.9	4.0
Nozzle diameter (1/100 mm)	72	94	110	135
Pre-chamber (printed on nozzle)	(X)	(Z)	(H8)	(S)
Reduced flow rate (W)	400	500	800	1600
<b>3 Natural gas G25/G25.3</b>	<b>AUX</b>	<b>SR</b>	<b>R</b>	<b>UR-3c</b>
Rated heating capacity (kW)	1.0	1.8	2.9	4.0
Nozzle diameter (1/100 mm)	72	94	121	148
Pre-chamber (printed on nozzle)	(F1)	(Y)	(F2)	(F3)
Reduced flow rate (W)	400	500	800	1600
<b>4 Natural gas G25.1</b>	<b>AUX</b>	<b>SR</b>	<b>R</b>	<b>UR-3c</b>
Rated heating capacity (kW)	1.0	1.8	2.9	4.0
Nozzle diameter (1/100 mm)	77	100	134	152
Pre-chamber (printed on nozzle)	(F1)	(Y)	(F3)	(F3)
Reduced flow rate (W)	400	500	800	1600
<b>5 Natural gas G25</b>	<b>AUX</b>	<b>SR</b>	<b>R</b>	<b>UR-3c</b>
Rated heating capacity (kW)	1.0	1.8	2.9	3.9
Nozzle diameter (1/100 mm)	77	100	134	152
Pre-chamber (printed on nozzle)	(F1)	(Y)	(F3)	(F3)
Reduced flow rate (W)	400	500	800	1400
<b>6 Natural gas G2.350</b>	<b>AUX</b>	<b>SR</b>	<b>R</b>	<b>UR-3c</b>
Rated heating capacity (kW)	1.0	1.8	2.9	4.0
Nozzle diameter (1/100 mm)	94	120	165	210
Pre-chamber (printed on nozzle)	(Y)	(Y)	(F3)	(H3)
Reduced flow rate (W)	400	500	800	1600

# Installation



EN

<b>7 LPG G30/31</b>	<b>AUX</b>	<b>SR</b>	<b>R</b>	<b>UR-3c</b>
Rated heating capacity (kW)	1.0	1.75	2.9	4.0
Nozzle diameter (1/100 mm)	50	65	85	102
Pre-chamber (printed on nozzle)	-	-	-	-
Reduced flow rate (W)	400	500	800	1600
Rated flow rate G30 (g/h)	73	127	211	291
Rated flow rate G31 (g/h)	71	125	207	286
<b>8 LPG G30/31</b>	<b>AUX</b>	<b>SR</b>	<b>R</b>	<b>UR-3c</b>
Rated heating capacity (kW)	1.0	1.8	2.9	4.0
Nozzle diameter (1/100 mm)	50	65	81	94
Pre-chamber (printed on nozzle)	-	-	-	-
Reduced flow rate (W)	450	550	800	1600
Rated flow rate G30 (g/h)	73	131	211	291
Rated flow rate G31 (g/h)	71	129	207	286
<b>9 LPG G30/31</b>	<b>AUX</b>	<b>SR</b>	<b>R</b>	<b>UR-3c</b>
Rated heating capacity (kW)	1.0	1.8	2.9	3.8
Nozzle diameter (1/100 mm)	43	58	74	77
Pre-chamber (printed on nozzle)	(H2)	(M)	(Z)	(F4)
Reduced flow rate (W)	400	500	800	1600
Rated flow rate G30 (g/h)	73	131	211	291
Rated flow rate G31 (g/h)	71	129	207	286
<b>10 Town gas G110</b>	<b>AUX</b>	<b>SR</b>	<b>R</b>	<b>UR-3c</b>
Rated heating capacity (kW)	1.0	1.8	2.8	3.8
Nozzle diameter (1/100 mm)	145	185	260	340
Pre-chamber (printed on nozzle)	(/8)	(/2)	(/3)	(/13)
Reduced flow rate (W)	400	500	800	1400

The nozzles not provided are available at Authorised Service Centres.



# Installation

## 5.3 Positioning



**Heavy appliance  
Crushing hazard**

- Position the appliance into the cabinet cut-out with the help of a second person.



**Pressure on the open door  
Risk of damage to the appliance**

- Never use the oven door to lever the appliance into place when fitting.
- Avoid exerting too much pressure on the door when open.



**Heat production during appliance operation  
Risk of fire**

- Veneers, adhesives or plastic coatings on adjacent furniture should be temperature-resistant (not less than 90 °C).

This appliance may be installed next to walls, one of which must be higher than the worktop, at a minimum distance of **X** mm from the side of the appliance, as shown in figures "A" and "C" relative to the installation classes.

Any wall units positioned above the worktop of the appliance must be at a minimum distance of at least **Y** mm. If a hood is installed above the hob, refer to the hood instruction manual to ensure the correct clearance is left.

<b>X</b>	150 mm
<b>Y</b>	750 mm

Depending on the type of installation, this appliance belongs to classes:

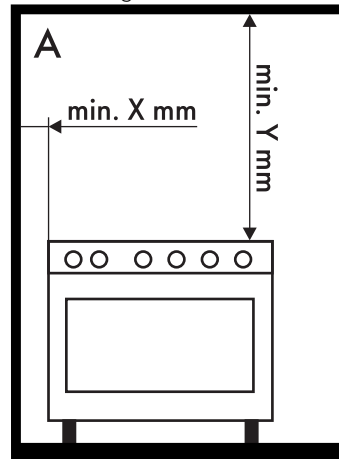

**A - Class 1**

**(Free-standing appliance)**

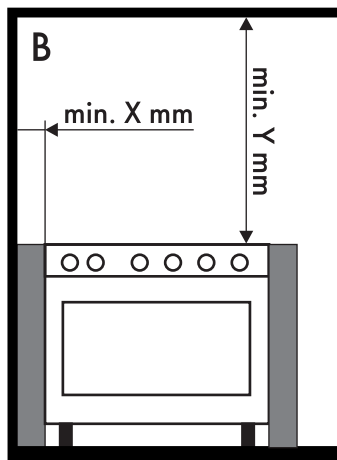

**B - Class 2 subclass 1**  
(Built-in appliance)

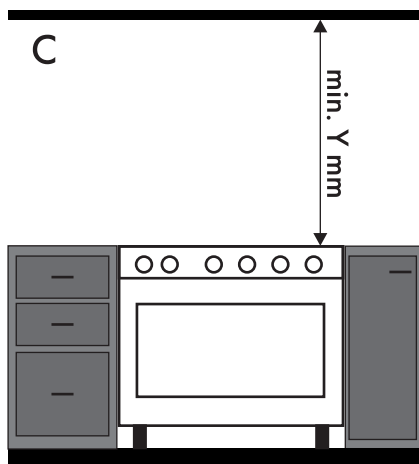

**C - Class 2 subclass 1**  
(Built-in appliance)

## Appliance overall dimensions

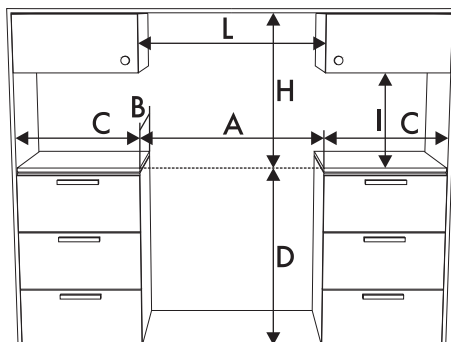

<b>A</b>	900 mm
<b>B</b>	600 mm
<b>C<sup>1</sup></b>	min. 150 mm
<b>D</b>	900 - 915 mm
<b>H</b>	750 mm
<b>I</b>	400 mm
<b>L<sup>2</sup></b>	900 mm

<sup>1</sup> Minimum distance from side walls or other flammable material.

<sup>2</sup> Minimum cabinet width (=A).



The appliance must be installed by a qualified technician and according to the regulations in force.



# Installation

Dimensions of the appliance: locations of gas and electric connections (mm)

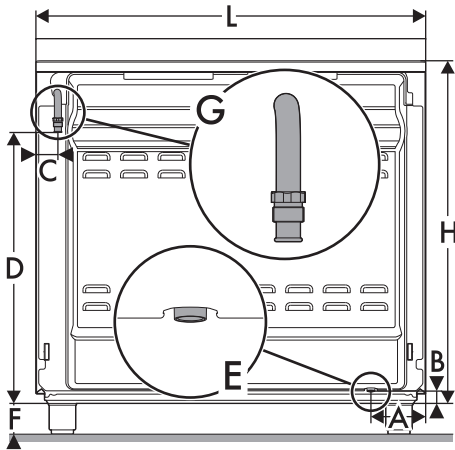

A	124
B	38
C	42
D	634
F	min. 105 - max. 160
H	776
L	898

**E** = Electrical connection

**G** = Gas connection

## Positioning and levelling



Heavy appliance

Risk of damage to the appliance

- Insert the front feet first and then the rear ones.

After making the electrical and/or gas connections, screw the four adjustable feet supplied with the appliance.

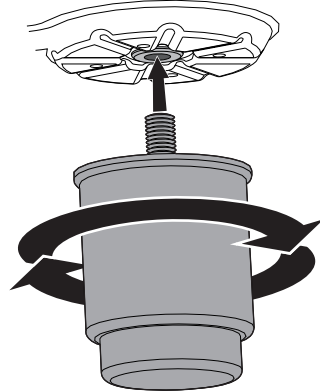

The appliance must sit level on the floor to ensure stability.

Screw or unscrew the bottom part of the foot until the appliance is stable and level on the floor.

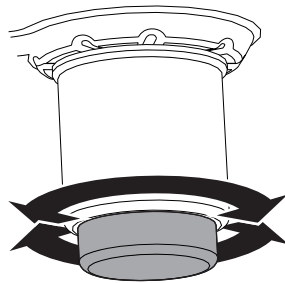





## Fastening to the wall



The anti-tip devices must be installed in order to prevent the appliance from tipping over.

1. Screw the wall fastening plate to the rear of the appliance.

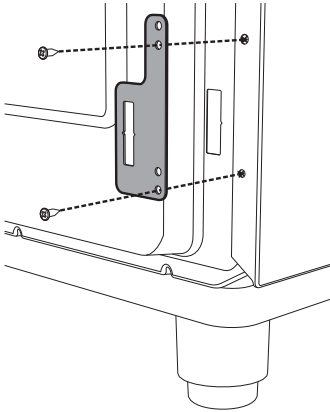

2. Adjust the height of the 4 feet.

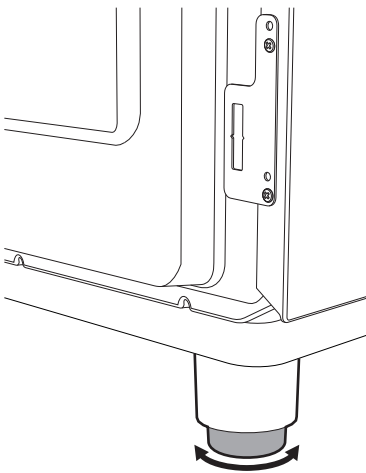

3. Assemble the fastening bracket.

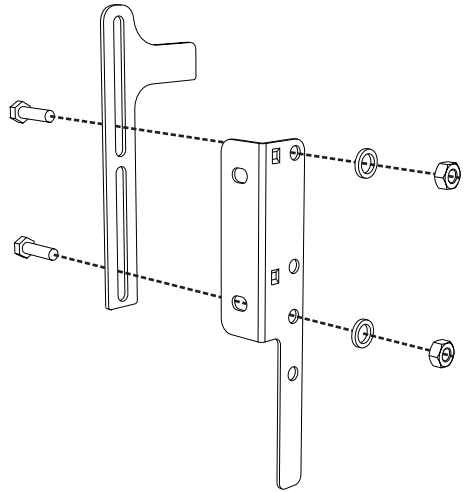

4. Align the base of the hook on the fastening bracket with the base of the slot on the wall fastening plate.

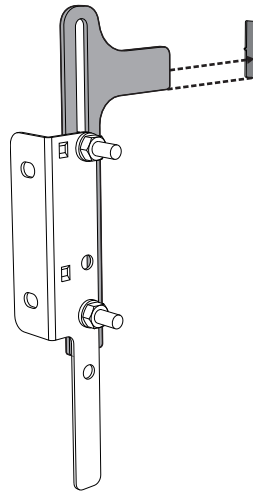



## Installation

5. Align the base of the fastening bracket with the ground and tighten the screws to fix the measurements.

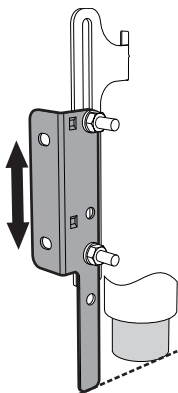

7. Move the bracket onto the wall and mark the position of the holes to be drilled in the wall.

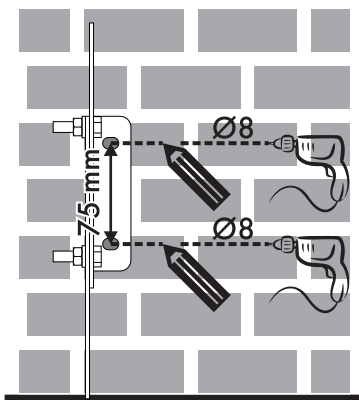

6. Use 50 mm for the distance from the side of the appliance to the bracket holes.

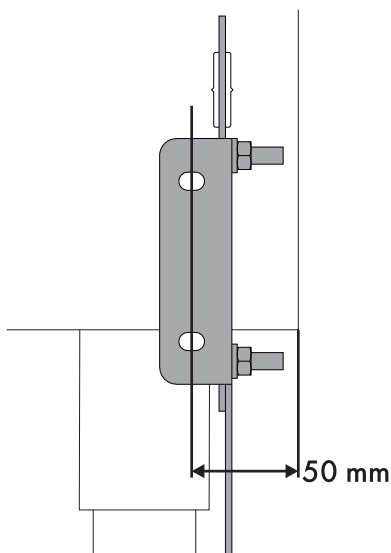

8. After drilling the holes in the wall, use wall plugs and screws to fasten the bracket to the wall.

9. Push the cooker towards the wall, and at the same time, insert the bracket in the plate fastened to the rear of the appliance.

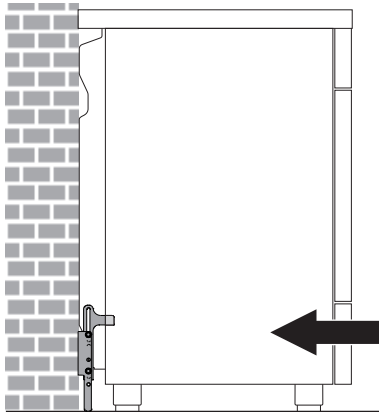



## Assembling the upstand

**i** The upstand provided is an integral part of the product; it must be fastened to the appliance prior to installation.

The upstand must always be positioned and secured correctly on the appliance.

1. Unscrew the 2 nuts (**B**) on the back of the hob.
2. Position the upstand above the hob, taking care to align the pins (**C**) with the holes (**D**).
3. Secure the upstand to the hob by tightening the screws (**A**).

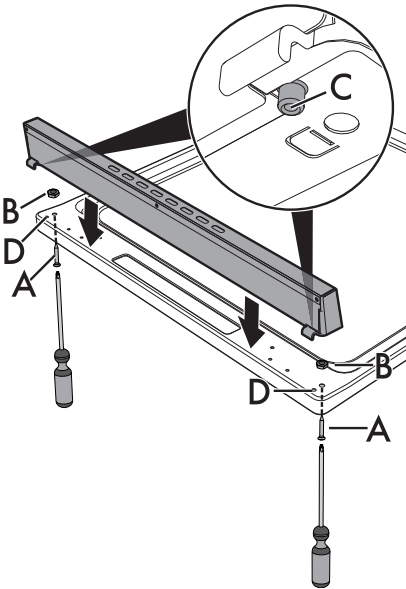



# Installation

## 5.4 Electrical connection



**Power voltage  
Danger of electrocution**

- Have the electrical connection performed by authorised technicians.
- Use personal protective equipment.
- The appliance must be connected to ground in compliance with electrical system safety standards.
- Disconnect the mains power supply.
- Do not pull the cable to remove the plug.
- Use cables withstanding a temperature of at least 90 °C.
- The tightening torque of the screws of the terminal board leads must be 1.5 - 2 Nm.

### General information

Check the mains characteristics against the data indicated on the plate.

The identification plate bearing the technical data, serial number and brand name is visibly positioned on the appliance.

Do not remove this plate for any reason.

Perform the ground connection using a wire that is 20 mm longer than the other wires.

The appliance can work in the following modes:

- **220-240 V 1N~**

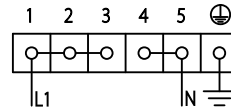

**3 x 2.5 mm<sup>2</sup> three-core cable.**

- **380-415 V 2N~**

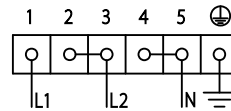

**4 x 1.5 mm<sup>2</sup> four-pole cable.**

- **220-240 V 2~**

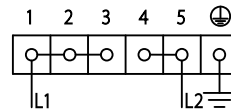

**3 x 2.5 mm<sup>2</sup> three-core cable.**

- **220-240 V 3~**

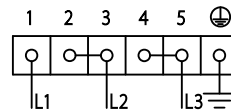

**4 x 1.5 mm<sup>2</sup> four-pole cable.**

- **380-415 V 3N~**

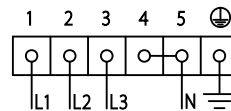

**5 x 1.5 mm<sup>2</sup> five-pole cable.**



The values indicated above refer to the cross-section of the internal lead.



The aforementioned power cables are sized taking into account the coincidence factor (in compliance with standard EN 60335-2-6).

## Fixed connection

Fit the power line with an all-pole disconnection switch, with a clearance between its contacts that allows the complete disconnection as per the overvoltage category III, in compliance with the installation regulations.

## 5.5 Instructions for the installer

- The plug must be accessible after installation. Do not bend or trap the power cable.
- The appliance must be installed according to the installation diagrams.
- Do not try to unscrew or force the threaded elbow of the fitting. You may damage this part of the appliance, which may void the manufacturer's warranty.
- Use soap and water to check for gas leaks on all connections. **DO NOT** use naked flames when looking for leaks.
- Turn on all the burners separately and then all together to make sure that the gas valve, burner and ignition are working properly.
- Turn the burner knobs to the minimum position and check that the flame is stable for each individual burner and all the burners together.
- If the appliance does not work correctly after having carried out all the checks, contact your local Authorised Service Centre.
- Once the appliance has been installed, please explain to the user how to use it correctly.



914779809/B