

PRECAUTIONS	28	Basic functions	35
General safety instructions	28	Menu bar functions	38
Installation	31	Settings menu	40
Appliance purpose	32	Using the hob	42
This user manual	32	Auxiliary functions	43
Manufacturer's liability	32	Safety features	45
Identification plate	33	Error notifications	46
Disposal	33	CLEANING AND MAINTENANCE	46
To save energy	33	Cleaning the glass ceramic hob	46
Information on power consumption in off/stand-by mode	33	What to do if...	47
How to read the user manual	33	INSTALLATION	47
DESCRIPTION	34	Electrical connection	47
General description	34	Power control menu (for installer only)	48
USE	34	Section cut from the countertop	48
Preliminary operations	34	Mounting	50
		Instructions for the installer	50

We advise you to read this manual carefully, which contains all the instructions for maintaining the appliance's aesthetic and functional qualities. For further information on the product: www.smeg.com

PRECAUTIONS

General safety instructions

Risk of personal injury

- During use the appliance and its accessible parts become very hot. Keep children well away from the appliance.
- Protect hands with heat resistant gloves during use.
- Never try to put out a fire or flames with water: Turn off the appliance and smother the flames with a fire blanket or other appropriate cover.
- This appliance may only be used by children aged 8 years and over, and by people of reduced physical, sensory or mental capacity, or lacking in experience in the use of electrical appliances, provided that they are supervised or have been given instructions on the safe use of the appliance and of the hazards associated with it.
- Children must not play with the appliance.
- Keep children under the age of eight at a safe distance unless they are constantly supervised.
- Keep children under the age of 8 away from the appliance when it is in use.
- Cleaning and maintenance must not be carried out by unsupervised children.
- Be aware of how rapidly the cooking zones heat up. Do not place empty pans on the heat. Danger of overheating.
- Activate the controls lock when

you have children or pets which could reach the hob.

- Do not touch or clean the hob surface during operation or when the residual heat indicator lights are still on.
- After use, switch off the plates. Never rely solely on the cookware detector.
- Supervise children carefully as they cannot readily see the residual heat indication. After use the cooking zones remain hot for a certain period of time even if they have been turned off. Keep children away from the cooking zones.
- The cooking process must always be kept under control. A short cooking process must be continuously monitored.
- **WARNING:** Cooking foods containing fat and/or oil without monitoring them can be dangerous and can cause a fire.
- Fats and oils can catch fire if they overheat. Do not leave the appliance unattended while preparing foods containing oils or fats. If fats or oils catch fire, never put water on them. Place the lid on the pan and turn off the relevant cooking zone.
- Do not use the Booster and/or the Double Booster functions (if present) to heat fats or oils. Fire hazard.
- Do not place metal objects,

such as dishes or cutlery, on the surface of the hob during cooking as they may overheat.

- Do not cook foods in closed tins or containers or plastic containers.
- Do not use magnetic tins.
- Do not use trivets or other items between the bottom of the pan and the glass ceramic surface. Danger of burns.
- Do not insert pointed metal objects (cutlery or utensils) into the slots in the appliance.
- Do not use or store flammable materials near the appliance or directly underneath the hob.
- Switch off the appliance immediately after use.
- Do not pull the cable to unplug the appliance (if present).
- **DO NOT USE AEROSOLS IN THE VICINITY OF THIS APPLIANCE WHILST IT IS IN USE.**
- **DO NOT MODIFY THIS APPLIANCE.**
- Always wear personal protective equipment (PPE) before carrying out any work on the appliance (installation, maintenance, positioning or moving).
- Do not clean the appliance if it is still hot or in operation.
- After use the cooking zones remain hot for a certain period of time after they have been turned off. Do not touch the hob

surfaces.

- Before performing any work on the appliance, switch off the power supply.
- Do not try to repair the appliance yourself or without the assistance of a qualified technician.
- If the power cable becomes damaged, contact technical support immediately to arrange for it to be replaced in order to avoid possible hazards.
- If cracks or fissures form, or if the glass ceramic cooking surface breaks, turn off the appliance immediately. Disconnect the power supply and call Technical Support.
- People who have pacemakers or other similar devices fitted must make sure that the operation of these devices is not affected by the induction field, the frequency range of which is between 20 and 50 kHz.
- In conformity with the provisions regarding electromagnetic compatibility, the electromagnetic induction cooking hob comes under group 2 and class B (EN 55011).

Risk of damaging the appliance

- Do not use abrasive or corrosive detergents (e.g. scouring powders, stain

removers and metallic sponges) on glass parts.

- Use wooden or plastic utensils.
- Do not sit on the appliance.
- Do not use the glass ceramic cooking surface as a support surface.
- Do not use the appliance as a support surface.
- Do not obstruct ventilation openings and heat dispersal slots.
- Do not use the hob if the pyrolytic cycle is taking place inside any oven installed below.
- Do not use steam jets to clean the appliance.
- Never leave the appliance unattended during cooking operations where fats or oils could be released, as these could then heat up and catch fire. Be very careful.
- Fire hazard: Never leave objects on the cooking surfaces.
- DO NOT FOR ANY REASON USE THE APPLIANCE AS A SPACE HEATER.
- Cooking vessels or griddle plates should be placed inside the perimeter of the hob.
- All pans must have smooth, flat bottoms.
- If any liquid does boil over or spill, remove the excess from the hob.
- Take care not to spill acid

substances such as lemon juice or vinegar on the hob.

- Do not spill sugar or sweet mixtures on the hob during cooking.
- Do not place materials or substances that could melt or catch fire (paper, plastic or aluminium foil) on the appliance while it is in use.
- Place the cookware directly on the glass ceramic surface.
- Do not put empty pans or frying pans on switched on cooking zones.
- Do not use rough or abrasive materials or sharp metal scrapers.
- The glass ceramic surface is highly resistant to impact. However, prevent hard, solid objects from falling on the cooking surface as they may cause it to break.
- Do not use cleaning products containing chlorine, ammonia or bleach on parts made of steel or that have metallic surface finishes (e.g. anodizing, nickel- or chromium-plating).
- This appliance is not intended to be operated by means of external timer or separate remote control system.
- To prevent scratching the glass surface, avoid sliding pots across it. Lift them and place them gently where needed instead.

Installation

- THIS APPLIANCE **MUST NOT BE INSTALLED** IN BOATS OR CARAVANS.
- Position the appliance into the cabinet cut-out with the help of a second person.
- Check that the carcass has the required openings.
- Check that the carcass material is heat resistant.
- Installation and servicing should be carried out by qualified personnel in accordance with current standards.
- Have the electrical connection performed by authorised technical personnel.
- The appliance must be connected to earth in compliance with electrical system safety standards.
- Use cables that can withstand temperatures of at least 90°C.
- Run the power cable in the rear part of the unit. Make sure that it does not come into contact with the lower part of the hob or a built-in oven below it.
- Be careful when connecting additional electrical appliances. Connection cables must not come into contact with hot cooking zones.
- The tightening torque of the screws of the terminal supply wires must be 1.5 - 2 Nm.
- Do not attach the appliance too tightly to the unit as this

could cause damage during use or partially obstruct the heat dispersal slots.

- The power cable must only be installed or replaced by a qualified technician.
- If the power cable becomes damaged, contact technical support immediately to arrange for it to be replaced in order to avoid possible hazards.
- Always use any necessary/required personal protective equipment (PPE) before performing any work on the appliance (installation, maintenance, positioning or movement).
- Before performing any work on the appliance, switch off the power supply.
- Allow the appliance to be disconnected after installation, via an accessible plug or a switch in the case of a fixed connection.
- Fit the power line with an all-pole circuit breaker with a contact separation distance sufficient to provide complete disconnection in category III overvoltage conditions, pursuant to installation regulations.
- This appliance can be used up to a maximum altitude of 2,000 metres above sea level.

For this appliance

- This appliance does not come with devices to fasten it to the built-in structure, as its overall weight is sufficient to ensure stability once it is in place.

Appliance purpose

This appliance is intended for cooking food in the home environment. Every other use is considered inappropriate. It cannot be used:

- in employee kitchens, shops, offices and other working environments.
- in farms/farmhouses.
- by guests in hotels, motels and residential environments.
- In bed and breakfast accommodation.

This user manual

- This user manual is an integral part of the appliance and must therefore be kept in its entirety and within the user's reach for the whole working life of the appliance.
- Read this user manual carefully before using the appliance.
- The explanations in this manual include images, which describe all that regularly appears on the display. However, it should be kept in mind that the appliance may be equipped with an updated version of the system, and as such, all that appears on the display may differ from those in the manual.

Manufacturer's liability

The manufacturer declines all liability for damage to persons or property caused by:

- use of the appliance other than that specified;
- failure to comply with the instructions in the user manual;
- tampering with any part of the appliance;
- use of non-original spare parts.

Identification plate

The identification plate bears the technical data, serial number and brand name of the appliance. Do not remove the identification plate for any reason.

Disposal



This appliance conforms to the WEEE European directive (2012/19/EU) and must be disposed of separately from other waste at the end of its service life.

The appliance does not contain substances in quantities sufficient to be considered hazardous to health and the environment, in accordance with current European directives.



Power voltage Danger of electrocution

- Disconnect the mains power supply.
- Unplug the appliance.

To dispose of the appliance:

- Cut the power cable and remove it.
- Deliver the appliance to the appropriate recycling centre for electrical and electronic equipment waste, or return it to the retailer when purchasing an equivalent product, on a one for one basis.

Our appliances are packaged in non-polluting and recyclable materials.

- Deliver the packing materials to the appropriate recycling centre.



Plastic packaging Danger of suffocation

- Do not leave the packaging or any part of it unattended.
- Do not let children play with the plastic bags.

To save energy

- The diameter of the base of the pan must not extend beyond the lines printed on the glass ceramic surface.
- Pans must not be placed outside the perimeter of the hob or on the display.
- When buying a pan, check whether the diameter indicated is that of the base or the top of the pan, as the top is almost always larger than the base.
- When preparing dishes with long cooking

times, you can save time and energy by using a pressure cooker, which also helps to retain vitamins contained in the food.

- Make sure that the pressure cooker contains enough liquid as, if there is not enough and it overheats, this may cause damage to both the pressure cooker and the cooking zone.
- If possible, always cover pans with a suitable lid.
- Choose a pan suitable for the quantity of food to be cooked. A large, half-empty saucepan leads to a waste of energy.



Under certain circumstances, if the hob and the oven are used at the same time, the maximum power limit of the electrical system might be exceeded.

Information on power consumption in off/stand-by mode

Technical data on the appliance's power consumption in off/stand-by mode can be found at www.smeg.com under the page corresponding to the product in question.

How to read the user manual

This user manual uses the following reading conventions:



Warning/Caution



Information/Advice

DESCRIPTION

General description

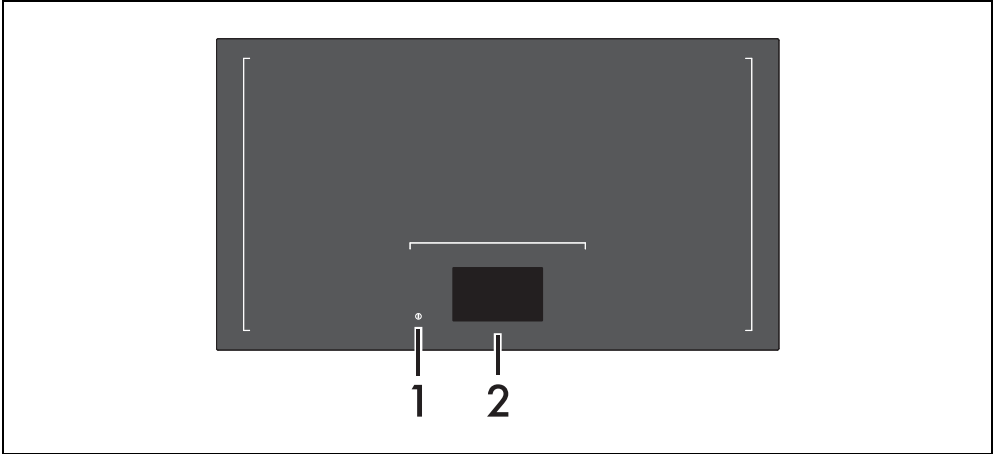

- 1 On/off button
- 2 Display

Advantages of induction cooking



The appliance is equipped with an induction generator for each cooking zone. Each generator located under the glass ceramic cooking surface creates an electromagnetic field which induces a thermal current in the base of the pan. This means the heat is no longer transmitted from the hob to the pan but created directly inside the pan by the inductive current.

- Energy saving thanks to the direct transmission of energy to the pan (suitable magnetisable cookware is required) compared to traditional electric cooking.
- Improved safety as the energy is only transmitted to the pan placed on the hob.
- High level of energy transmitted from the induction cooking zone to the base of the

pan.

- Rapid heating speed.
- Reduced danger of burns as the cooking surface is only heated under the base of the pan; foods which overflow do not stick.

Power control

The hob is fitted with a power control module that optimises/limits consumption. If the overall set power level exceeds the maximum limit permitted, the electronic circuit board will automatically manage the power supplied by the hot plates. The module tries to maintain the maximum deliverable power levels. Levels set by the automatic control will appear on the display.



Priority is given to the last zone set.



The power control module does not affect the total power consumption of the appliance.

USE

Preliminary operations



See General safety instructions.

- Remove any protective film from the outside or inside of the appliance, including any

accessories (if present).

- Remove any labels (apart from the technical data plate).

Basic functions

First power connection

When connected to the power supply for the first time, or after power has been switched back on after a power failure, the display shows the factory pre-set time for approximately 20 seconds:

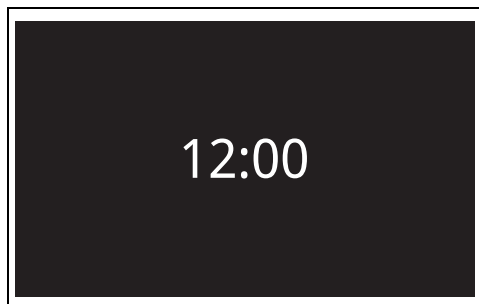



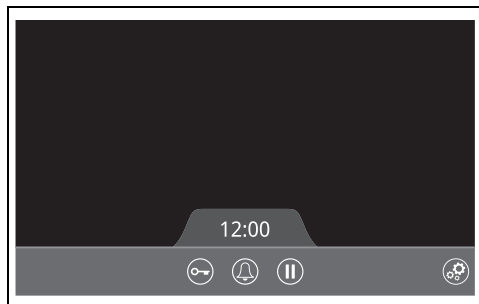

Switching on and off

 The factory pre-set language for the display is English. To change the language see "Settings menu".

Press the  button to turn the appliance on or off. When the appliance is turned on, the display shows the initial screen and emits a sound:



Under the time indicator, there is the menu bar on which the buttons associated with the following functions can be found (see "Menu bar functions"):

	Controls lock
	Independent timer
	Pause function
	Settings menu

To turn off the appliance, press the  button

until a sound is emitted. The current time is displayed for approximately 20 seconds.

Pan recognition

The appliance is equipped with an automatic pan detection system that recognizes the position and the size of the pan. Pans are indicated on the display by three circles that have a predetermined size, regardless of the shape of the pan.

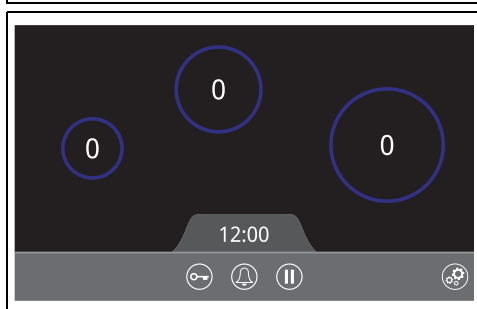
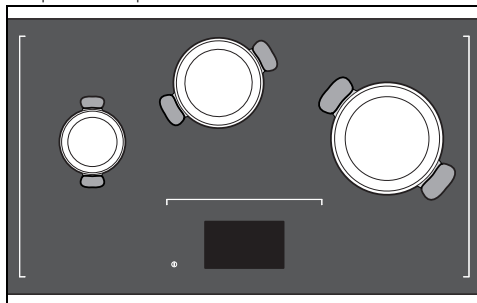

 Pans are detected automatically when the appliance is switched on.

Positioning the pans

The glass ceramic surface is designed for up to a maximum of 6 pans at the same time.

In order for the pans to be detected correctly and for the heat to be transmitted efficiently, it is best to use circular pans, the diameters of which fall within the following limits:

Minimum recommended diameter	145 mm
Maximum recommended diameter	280 mm

Pans with diameters of between 100 and 145 mm are not detected in all positions.

Pans with a diameter greater than the maximum recommended one, or which are non-circular, are only detected after the appliance has been

switched on, and should only be placed at the back of the surface:

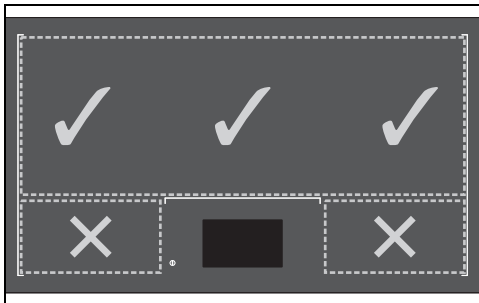

If a pan that is too large or non-circular is placed on the surface before it is switched on, it might be recognized as two separate pans. In this case, simply move the pan slightly on the surface or lift it and put it back down, until it is detected correctly.

It is recommended to leave a space of a few centimetres between the pans.



Make sure that you always position the pans within the lines printed on the glass ceramic surface and do not to place them too close to the display.

Pan positioning errors

Incorrect detection:

When pans are placed on the surface, sometimes the automatic detection system may not be able to determine their exact position.

The following message will appear on the display:

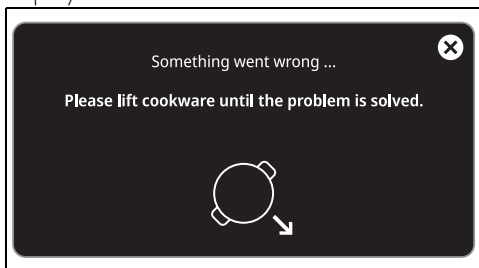

Touch the **X** icon to close the error message.

The problem can be overcome by simply lifting the pan. The error message disappears and the appliance resumes normal operation.

Pan is too small:

If you place a pan that is too small on the surface of the appliance, it appears in grey on

the display with an exclamation mark above it:

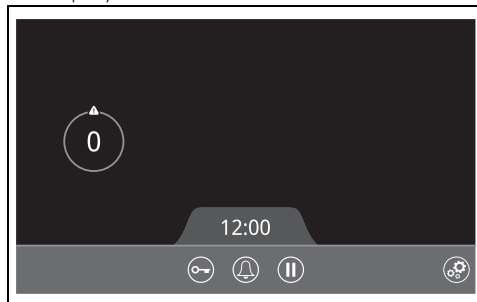

If you select the pan on the display and wish to set a power level (e.g. 5), the number of the required power level appears in red, indicating that it is not possible to complete the operation:



Touch the **!** icon to display the error message:

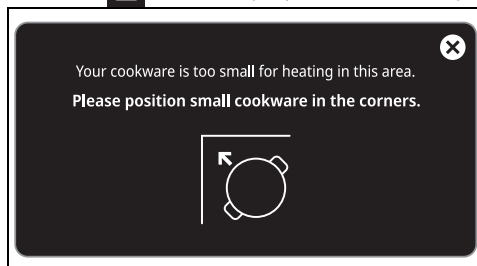

Touch the **X** icon to close the error message.

To overcome the problem, place the pan in a corner, inside the lines printed on the hob, or use a larger pan.

Cookware too close to the display:

If a pan is placed too close to the display or if a hot pan is detected close to it, the following

message appears and a sound is emitted:

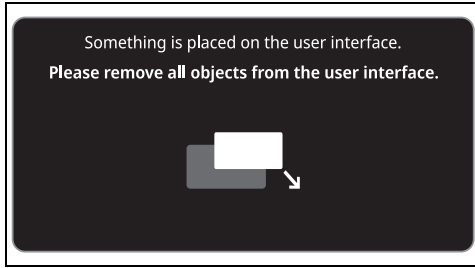

Touch the  icon to close the error message and move the pan away from the display.

Moving pans



The appliance is designed to heat pans at any point on the glass ceramic surface, without having specific cooking zones.

If you move a pan, the appliance detects that it has been moved and displays it in the new position:

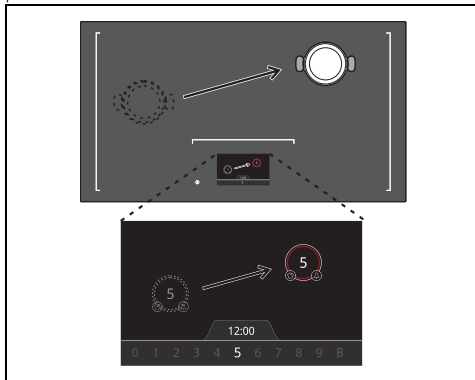

When you lift a pan, the appliance pauses all operations that are in progress (both cooking and timed cooking) and the pan is shown in grey on the display.



If the pan is repositioned within 20 seconds, all the operations that were in progress are restored. Otherwise, they will not be saved and will need to be set again.

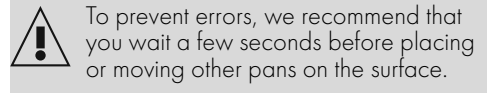

Errors when moving pans

If two pans with large differences in power levels are positioned close to one another, the power management system limits the energy supplied.

For safety reasons, it is always the highest power level that is limited in order to adapt it to being close to another pan, in the following two cases:

- 1 Pan with high power level next to one with a low power level.
- 2 Pan with low power level next to one with a high power level.

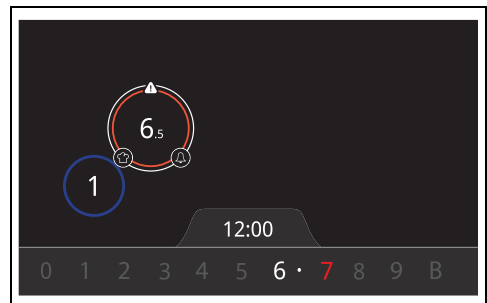
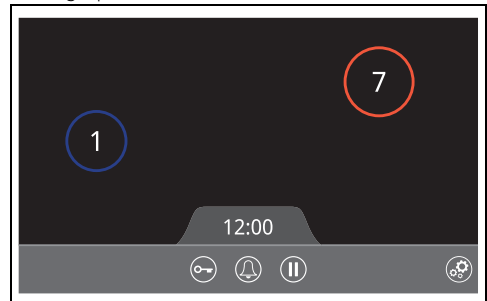

The pan with the highest power level (level 7 shown in red) is limited to the maximum level available (level 6.5 shown in white).

Touch the  icon to display the error message:

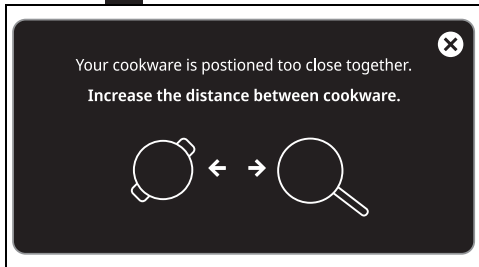

Touch the  icon to close the error message.

The problem can be overcome in two ways:

1. Remove the pan with the highest level within 10 seconds; the set power level is restored.
2. Accept the maximum power level available without removing the pan; the error message disappears within 10 seconds.

Cookware suitable for use in induction cooking

Cookware used on the induction cooking surface must be made of metal, with magnetic properties and a sufficiently large base.

Suitable cookware:

- Enamelled steel cookware with thick bases.
- Cast iron cookware with an enamelled base.
- Cookware in multilayer stainless steel, ferritic stainless steel and aluminium with a special base.

Unsuitable cookware:

- Copper, stainless steel, aluminium, fireproof glass, wood, ceramic and terracotta cookware.

If you place an unsuitable pan on the surface of the appliance, it will be indicated in grey on the display, with an exclamation mark above it:

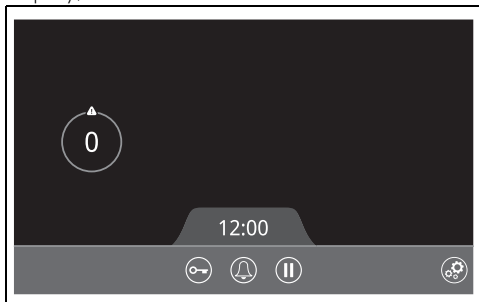

If you select the pan on the display and wish to set a power level (e.g. 5), the number of the

required power level appears in red, indicating that it is not possible to complete the operation:



Touch the  icon to display the error message:

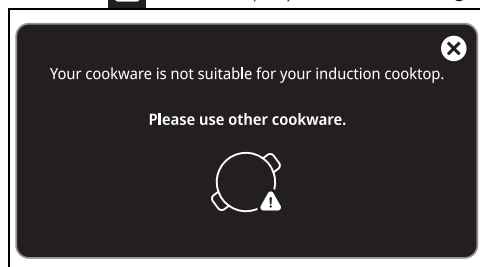



Touch the  icon to close the error message.

To overcome the problem, remove the pan and use one that is suitable for induction cooking.

Menu bar functions

Controls lock

Useful when cleaning the appliance or to prevent functions being activated by mistake. To activate the controls lock, press the  button. The entire display, apart from the central key button and the  button is locked.

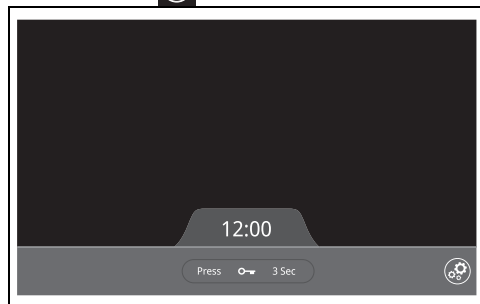

To deactivate the controls lock, press and keep the key icon pressed for 3 seconds; an animation indicates that deactivation is in

progress:

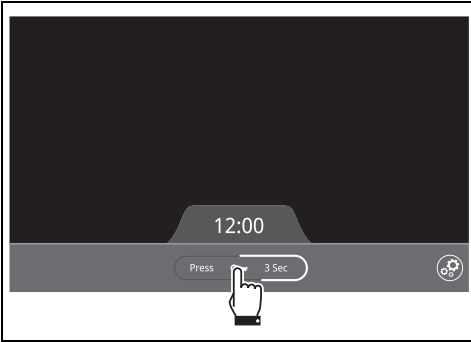

- For safety reasons, the  button is always active.
- The controls lock function remains active even if the appliance is turned off and then on again.
- When the power comes back on after a power failure, the function will be deactivated.

Independent timer



- A maximum of 9 hours and 59 minutes can be set.
- Using the independent timer does not switch off the cooking zones, it only informs the user when the set minutes have elapsed.

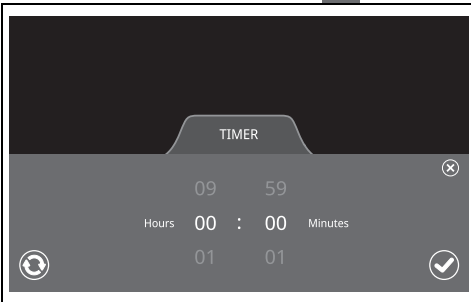

This function is used to set a timer that will emit a sound at the end of the pre-set time. To activate the independent timer, press the  button.



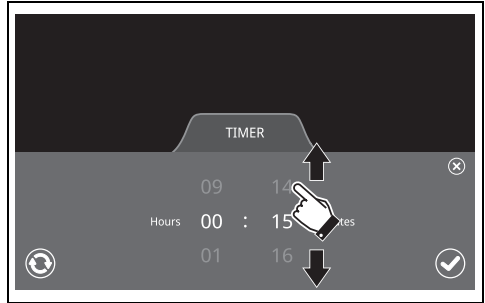

Scroll through the minutes and hours to select

the required time:



- Press the  button to confirm the selection.
- Press the  button to reset the timer.
- Press the  button to close the timer menu.

Once confirmed, the timer menu disappears and the countdown begins, which is shown in the menu bar of the display. When the timer has elapsed, press the flashing digits "00:00" to stop the audible signal.

When the independent timer is active and you wish to modify or deactivate it, simply press the digits of the timer in progress and set a new timer. Confirm with  or use  to reset it.



- When the timer has elapsed, the sound switches off after approximately 30 seconds of inactivity
- The timer menu closes automatically after 10 seconds of inactivity.

Pause function



When this function is active, the cooking zones do not produce heat and all the timers are paused.

This function can be used to pause the operation of the hob for a limited length of time. Press the  button to activate the function. The pause function is now active.

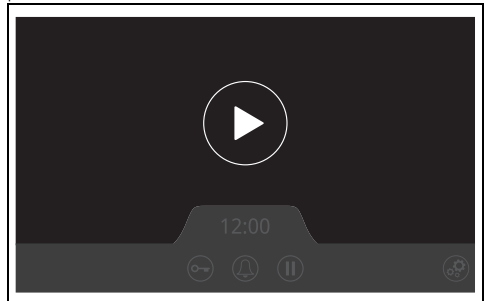







Touch the play symbol in the centre of the display to deactivate the pause function and restore the operation of the appliance.

- The maximum duration of the pause function is 10 minutes, after which the hob is switched off automatically.
- However, the residual heat indicators and the cooking duration limitation system remain active.

Settings menu

The settings menu allows you to configure some of the appliance's functions and personalise the display.

There are 7 options that can be configured:

	Personalise
	Child lock
	Sound
	Brightness
	Time setting
	Language
	Factory reset

On the initial screen, press the  button to call up the settings menu:

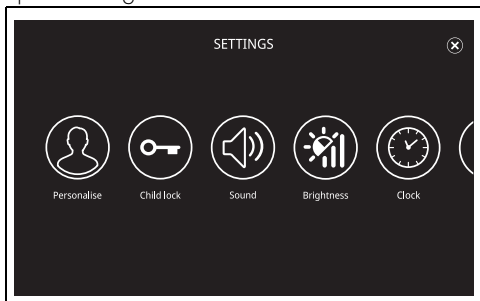

Swipe left to view the options that are not visible

on the first screen:

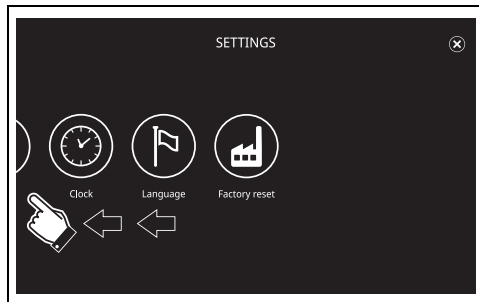

Press the  button to close the settings menu at any time.

Personalise

This setting allows you to hide or display the icons relating to the functions of the menu bar on the initial screen.

Press the icon above "Personalise" to access the relative menu:

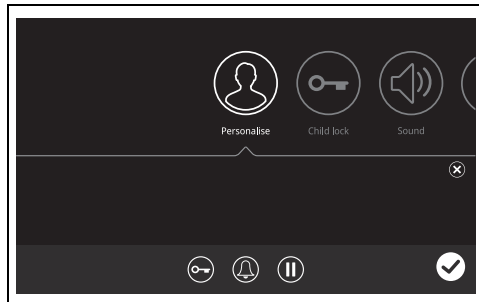

To hide a function, simply touch the corresponding icon (e.g. the pause icon - 1), which will be moved into the space above (2).

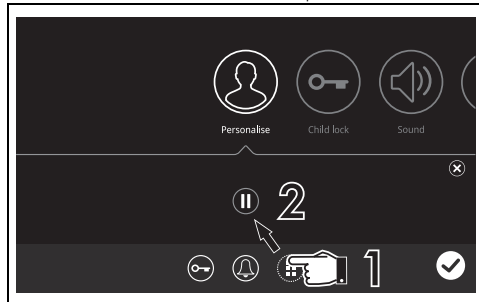



This function will no longer be displayed on the menu bar. It is also possible to hide all the other icons of the menu bar functions.

To make a hidden function visible again, touch the relative icon in the central area (e.g. the pause icon - 1), which will be placed in the menu bar, to the right of any icons that are

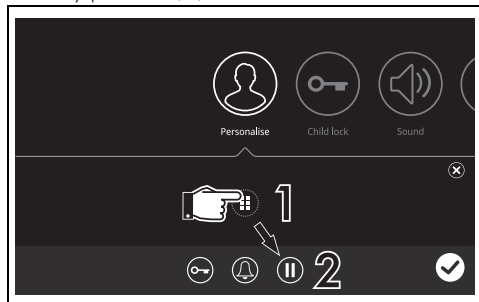
already present. (2).



- Press the  button to save the selection.
- Press the  button to discard the selection.

The "Personalise" menu closes and you are taken back to the settings menu.

Child lock

This setting prevents the appliance from being switched on unintentionally (for example by children) and works like an access password.

To enable the setting, press the icon above "Child lock" to go to the relative menu and select "ON":

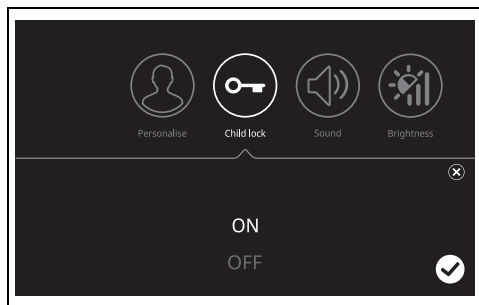

- Press the  button to cancel.
- Press the  button to confirm.

The following screen appears:

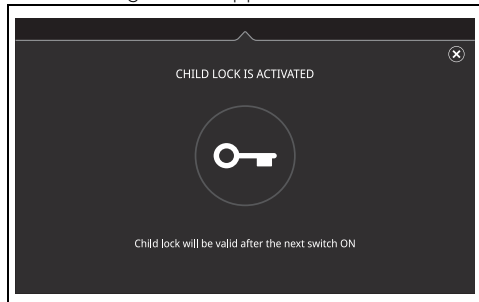

Press  or wait a few seconds to close the message and go back to the settings menu.

The child lock setting will be enabled after the appliance is turned off and on again using the  button. The following screen will appear:

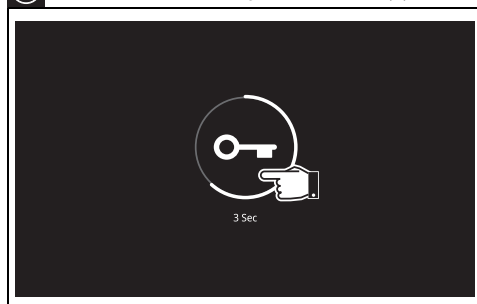

Press the key symbol in the centre for 3 seconds; an animation indicates that the display is being unlocked. The display is now unlocked.

 • The unlock screen appears every time the appliance is switched off and on.

• Unlocking the display does not disable the Child Lock setting.

• When the power comes back on after a power failure, the function will not be deactivated.

To deactivate the setting, you have to go to the settings menu and select "OFF" in the "Child lock" submenu.

Sound

This setting allows you to adjust the volume of the device's acoustic signals and sounds. Press the icon above "Sound" to access the relative menu.

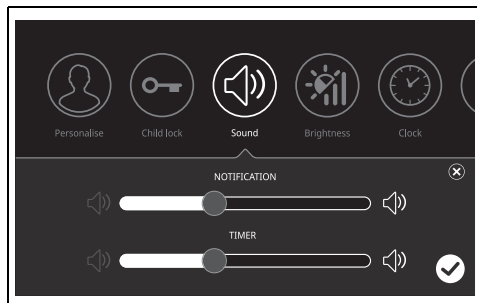

The "Notification" bar adjusts the volume of all sounds apart from the volume of the elapsed timer signal. The "Timer" bar only adjusts the volume of the timer sound signal. The far left end of a bar mutes the volume, while the far right increases the volume to the maximum.

- Press the  button to cancel.
- Press the  button to confirm.

 It is not possible to mute sounds associated with the appearance of error messages and with switching the appliance on and off.

Brightness

This option adjusts the brightness of the display. Press the icon above "Brightness" to access the relative menu.

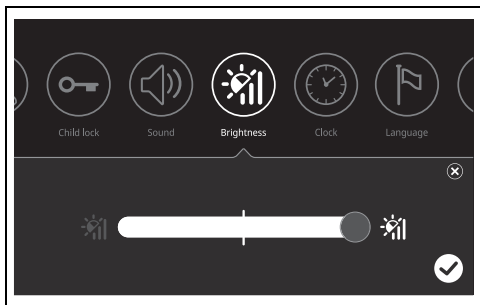

Adjust the brightness using the bar.

- Press the  button to cancel.
- Press the  button to confirm.

Time setting

This option allows you to adjust the current time. Press the icon above "Time setting" to access the relative menu.

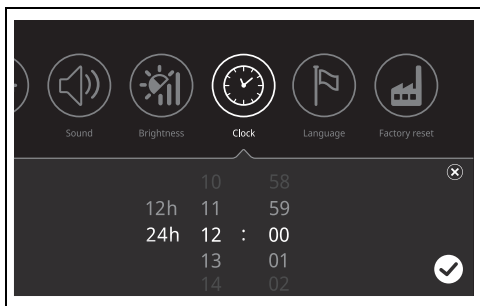

Swipe with your finger to select the time and the required time format.

- Press the  button to cancel.
- Press the  button to confirm.

Language

This option allows you to select the language of the display. Press the icon above "Language" to

access the relative menu.

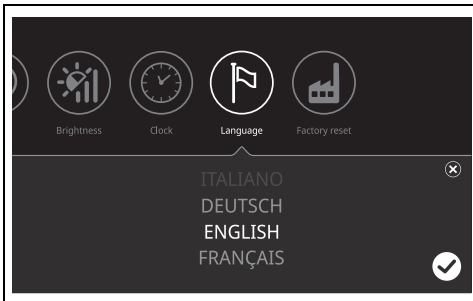



Swipe with your finger to select the required language.

- Press the  button to cancel.
- Press the  button to confirm.

Factory reset

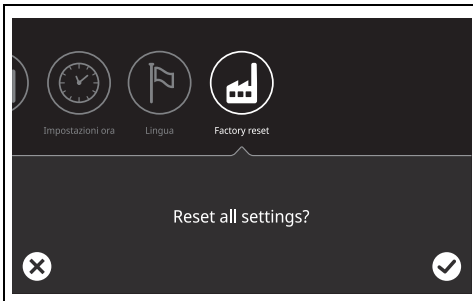
This option allows you to reset all other settings to the factory-set parameters. Press the icon above "Factory reset" to access the relative menu.



- Press the  button to cancel.
- Press the  button to confirm.

Using the hob

With the appliance switched on, place a non-empty pan suitable for induction cooking on the glass ceramic surface. The pan appears as a circle on the display:

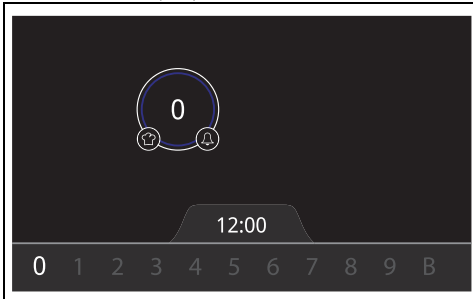

As soon as the pan is placed on the surface, the appliance goes into selection mode, which makes it available for cooking. A concentric white circle and the following elements appear:

 After a few moments of inactivity, the pan will be deselected and you have to touch the pan on the display in order to select it again.

1 Power level bar



With which you can select the required power level. Select a power level by tapping on or sliding your finger to the corresponding number.

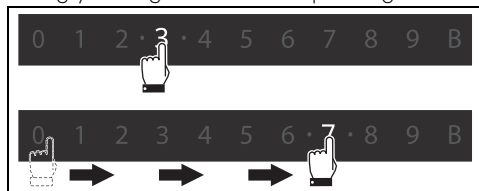

Intermediate power levels can be set between the whole numbers. They are indicated by dots between one number and another. For example, power level 4.5:



To stop supplying power and stop heating the pan, carry out the following procedure at any time:

- Select power level "0".
- Touch the pan on the display twice.
- Press the  button to turn off the appliance.

2 Automatic programs icon (see "Auxiliary functions"):

Accesses a submenu that contains some useful functions for preparing and cooking food.

3 Timed cooking icon (see "Auxiliary functions"):

Allows you to activate a timer that switches off heating at the end of the set time.

Power level table

Power level	Suitable for:
0	OFF setting
from 1 to 2	Cooking small amounts of food (minimum power)
from 3 to 4	Cooking
from 5 to 6	Cooking large quantities of food, roasting larger portions
from 7 to 8	Roasting, slow frying with flour
9	Roasting
B	Bring a large amount of water to the boil (maximum power, see "Booster function")

The pans indicated on the display are shown in different colours according to the power level:

- Level 0: blue
- from 1 to 3.5: violet/purple
- from 4 to 6.5: red
- from 7 to B: orange

Booster function

 See General safety instructions.

The Booster function allows you to heat a pan at maximum power for a limited amount of time. It can be used to bring a large amount of water to the boil rapidly.

To activate the Booster function, select power level "B" at the far right of the bar.



Select any other power level to deactivate the Booster function.

 The Booster function remains active for a maximum of 10 minutes, after which it switches off automatically.

Auxiliary functions

Auxiliary functions allow you to activate specific functions that apply to a single pan.

Automatic programs

These functions have a pre-set power level, useful as a real cooking aid.

With the appliance switched on and a pan

resting on the surface, touch the icon 

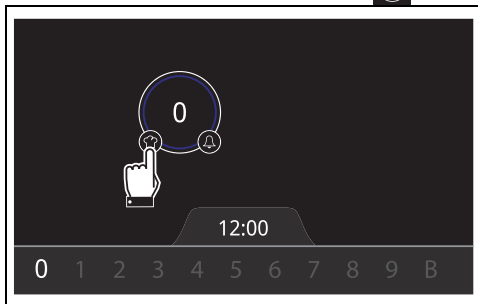

The following screen appears:

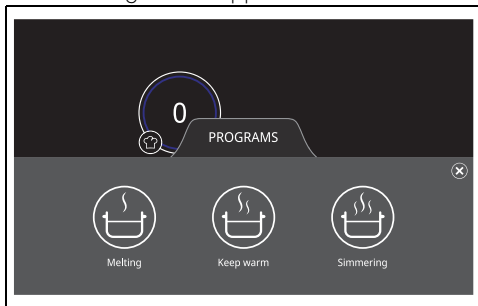

Melting: suitable for melting chocolate or butter.



Reheat: useful for keeping cooked food warm.



Simmering: suitable for slow cooking.

- Press the  button to close the programs menu.
- Touch an icon to activate the corresponding function. The programs menu closes and the function becomes active.

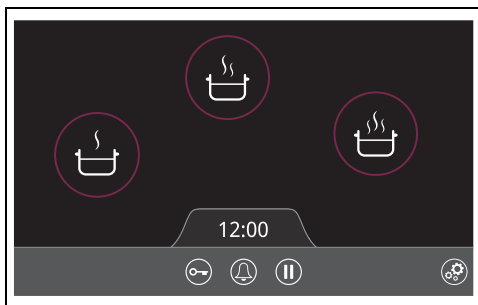

To deactivate automatic programs:

1. Select the pan on the display and set the power level to "0".

2. Tap the pan on the display twice to deactivate the heating function quickly.
3. Access the programs menu using the  button and touch the icon of the program you wish to deactivate.

Timed cooking

Allows you to activate a timer that deactivates the heating function at the end of the set time and emits a sound.



- This function can also be activated if a power level has not been set or if the appliance detects that the pan has been lifted from the surface.
- A maximum of 9 hours and 59 minutes can be set.

With the appliance switched on and a pan resting on the surface, touch the icon 

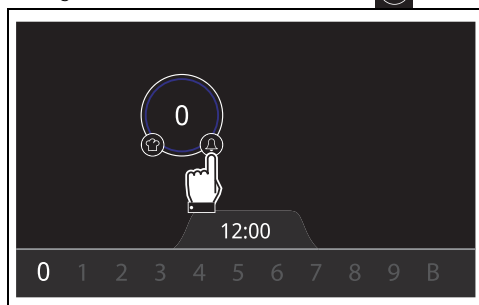



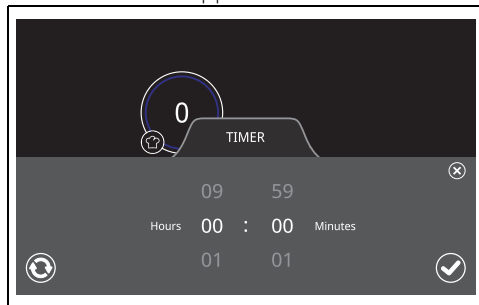

The relative menu appears:

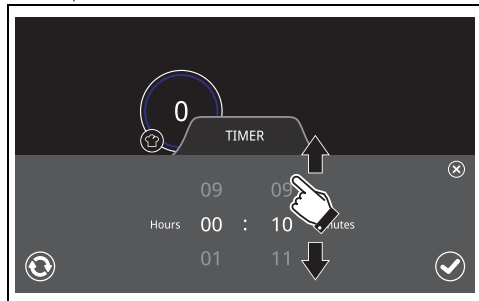

Scroll through the hours and minutes to select

the required time.



- Press the  button to confirm the selection.
- Press the  button to reset the timer.
- Press the  button to close the timer menu.

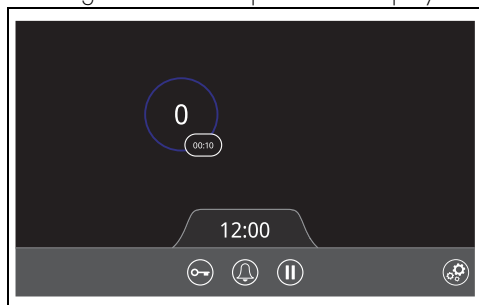

Once confirmed, the timer menu disappears and the countdown begins. It is displayed in the lower right corner of the pan on the display.



When the timer has elapsed, heating is deactivated.

To stop the sound, press the flashing digits "00:00" or lift the pan and put it down again after a few seconds.

When the pan timer is active and you wish to modify or deactivate it, simply press on the digits of the timer in progress and set a new timer.

Confirm with  or use  to reset it.



- If you wish to change the countdown, the current timer is paused and resumes when the new timer is confirmed.
- When the timer has elapsed, the sound switches off after approximately 30 seconds of inactivity
- The timer menu closes automatically after 10 seconds of inactivity.

Safety features



See General safety instructions.

Limiting the cooking duration

The appliance has an automatic device that limits the duration of use.

If the cooking settings for a pan are not changed, the maximum operation time for each zone depends on the power level selected.

Heating is switched off when the device for limiting the duration of use is activated.

Power level	Maximum cooking duration in hours:
Automatic programs	2 h
1 and 1.5	10 h
form 2 to 3.5	5 h
4 and 4.5	4 h
5 and 5.5	3 h
from 6 to 8.5	2 h
9	1 h
Booster (B)	10 minutes

Residual heat indicators

If the temperature of any part of the glass ceramic surface exceeds a specific safety threshold, it is indicated on the display as an area that covers a third of the display with the letter "H" in the centre.

- With the appliance switched on (example):

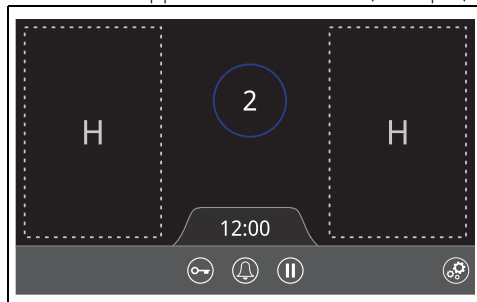

- With the appliance switched off (example):

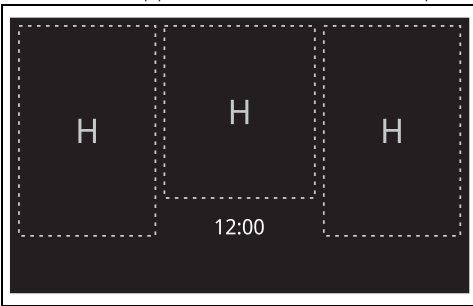

In both cases, the relative residual heat indicator disappears as soon as the temperature of a cooking zone falls below the safety threshold.

Protection from overheating

If the appliance is used on full power for a long period, the electronics will have trouble cooling down if the room temperature is high or if there are hot pans close to the display.

In order to protect the internal components from overheating, 3 temperature thresholds have been set:

- 1 Minimum temperature threshold: a warning message is displayed (see "Pan positioning errors"). In this case, the appliance continues to operate normally.
- 2 Intermediate temperature threshold: an error message is displayed.

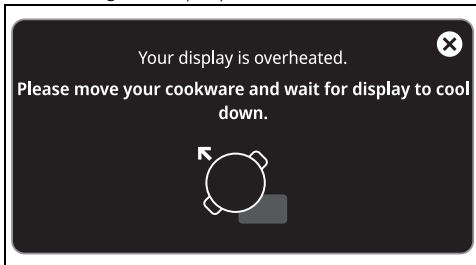

Move the pan away from the display and wait for it to cool down without using the appliance. When the display has cooled down sufficiently, the message disappears and the appliance can be used normally.

- 3 Maximum temperature threshold: The appliance switches off automatically. Wait for it to cool down completely before turning it on again.

Error notifications

If the appliance malfunctions or operates incorrectly, the associated error code appears on the display.

The error codes always begin with the letter "E" or "Er" followed by a series of digits (e.g. "Er47-30").

Errors coded as:

- "E02"
- "E2"
- "Er21"

Indicate that the appliance or part of it is overheating. If this occurs, you should switch off the appliance immediately, remove all pans and let it cool down.

If these errors persist or if other errors appear, make a note of the code and contact Technical Support.

CLEANING AND MAINTENANCE

Cleaning the glass ceramic hob

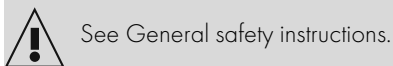

Cleaning the surfaces

To keep the surfaces in good condition, they should be cleaned regularly after use. Let them cool first.

Ordinary daily cleaning

Always and only use specific products that do not contain abrasives or chlorine-based acids. Pour the product onto a damp cloth and wipe the surface, rinse thoroughly and dry with a soft

cloth or a microfibre cloth.



In case of stubborn dirt, clean when cold using a damp kitchen sponge and neutral detergent; then dry with a microfibre cloth.

Weekly cleaning

Clean and maintain the hob once a week using an ordinary glass ceramic cleaning product. Always follow the manufacturer's instructions. The silicon in these products creates a protective, water-repellent membrane which also resists dirt. All marks stay on the membrane and can therefore be removed easily. After cleaning, dry the surface with a clean cloth. Make sure that there is no detergent left on the cooking surface as it might undergo an aggressive reaction when heated up and could modify the structure of the cooking surface.

Food stains or residues

Light coloured marks from pans with aluminium bases can be easily cleaned off with a cloth moistened in vinegar. Remove any burnt-on residues after cooking; then rinse with water and dry thoroughly with a clean cloth. Dirt, which may have fallen on the hob while cleaning lettuce or potatoes, can scratch the hob when moving pans. Consequently, remove any dirt from the cooking surface immediately. Changes in colour do not affect the operation and stability of the glass. These are not alterations to the material of the hob but just residues which have not been removed and have then carbonised. Shiny surfaces can form due to the bases of pans, especially aluminium ones, rubbing on the surface, and due to the use of unsuitable detergents. They are difficult to remove using conventional cleaning products. It may be necessary to repeat the cleaning process several times. Use of corrosive detergents or rubbing of pan bases can wear away the decoration on the hob over time and

contribute to the formation of stains.



We recommend the use of cleaning products distributed by the manufacturer.



After cleaning, dry the appliance thoroughly to prevent any water or detergent from interfering with its operation or creating unsightly marks.

What to do if...

The hob does not work:

- Make sure that the hob is connected and that the main switch is turned on.
- Make sure that there is no power failure.
- Make sure that the fuse has not blown. In this case replace the fuse.
- Make sure that the circuit breaker of the residential electrical system has not tripped. In this case, reset the circuit breaker.

The cooking results are unsatisfactory:

- Make sure that the cooking temperature is not too high or too low.
- Make sure that the hob is properly ventilated and that the air inlets are unobstructed.
- Use cookware that is certified and tested for induction cooking.

The hob smokes:

- Let the hob cool down and clean it once cooking is complete.
- Make sure that the food has not spilled out of the pan and use a larger cooking vessel, if needed.

The fuses blow or the circuit breaker of the residential electrical system trips repeatedly.

- Call Technical Support or an electrician.

There are cracks or fissures in the hob:

- Turn off the appliance immediately, disconnect the power supply and contact Technical Support.

INSTALLATION

Electrical connection



See General safety instructions.

General information

Check the mains characteristics against the data

indicated on the plate.

The identification plate bearing the technical data, serial number and brand name is visibly positioned on the appliance.

Do not remove this plate for any reason.

The appliance must be connected to ground

using a wire that is at least 20 mm longer than the other wires.

The appliance can work in the following modes:

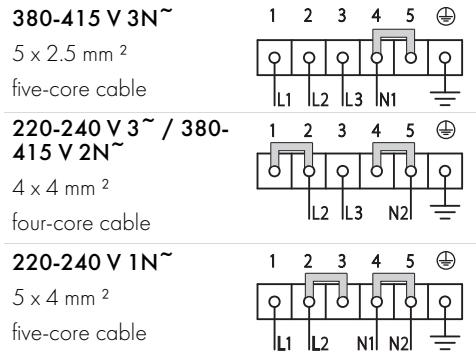

The values indicated refer to the cross-section of the internal conductor.

The aforementioned power cables are sized taking into account the coincidence factor (in compliance with standard EN 60335-2-6).

For all types of connection, use the jumper provided.

Fixed connection

Fit the power line with an all-pole circuit breaker with a contact separation distance sufficient to provide complete disconnection in category III overvoltage conditions, pursuant to installation regulations.

For the Australian/New Zealand market:

The circuit breaker incorporated in the fixed connection must comply with AS/NZS 3000.

Power control menu (for installer only)

You can set the value from a minimum of 2.4 kW to a maximum of 11.0 kW; the latter is the value pre-set at the factory.

The power control menu allows you to set the maximum power supplied by the appliance.

To access the menu:

1. Disconnect the appliance from the mains power supply.
2. Reconnect the appliance to the mains power supply.

3. Within 1 minute, briefly touch the lower right and left corners of the display at the same time:

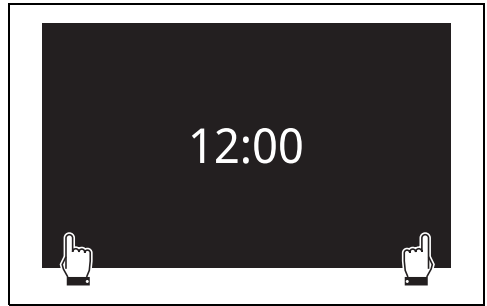

The following screen appears:

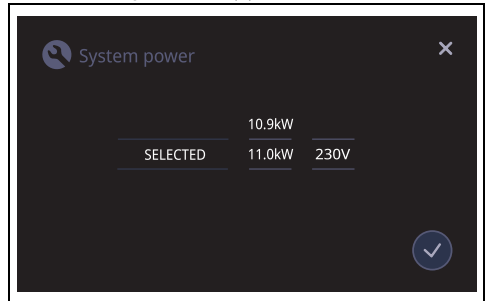

Use your finger to scroll through the available power settings, which can be selected in 0.1 kW steps. (Eco-Logic Advance function).

- Press to confirm the selection.
- Press to cancel.

In both cases, you exit from the power control menu and return to the screen showing the current time. On this screen, you can access the power control menu again by following the instructions in point 3.

The power control menu closes automatically after 2 seconds of inactivity.

Section cut from the countertop

Safety instructions for positioning and installation

See General safety instructions.

- Installation can be carried out on various materials such as masonry, metal, solid wood or plastic laminated wood as long as they are heat resistant (>90°C).
- Veneers, adhesives or plastic coatings on

adjacent furniture should be temperature-resistant (>90°C), otherwise they might warp over time.

- If the piece of furniture does not have the required recess opening, either it will have to be cut or masonry work carried out by a competent technician.
- The minimum clearance between exhaust hoods and the cooking surface must be at least the distance indicated in the exhaust hood installation instructions.
- The minimum clearances must also be respected for the edges of the hob on the back as indicated in the assembly instructions.
- If the appliance is to be installed above an oven, the oven must be fitted with a cooling fan.

edge of the hob before assembly.

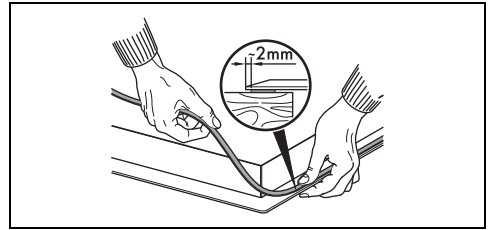

! Do not use silicone to secure the hob. This would make it impossible to remove the hob without damaging it.

In the case of flush mounting, after placing the adhesive seal (A) on the glass surface and after positioning and securing the hob, fill the edges with insulating silicone (B) and wipe off any excess. If for any reason the hob needs to be removed, cut the silicone using a cutter before attempting to remove it (C).

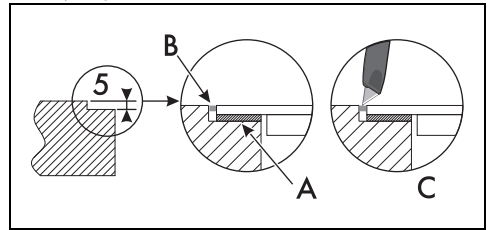

Semi-flush mounting (mm)

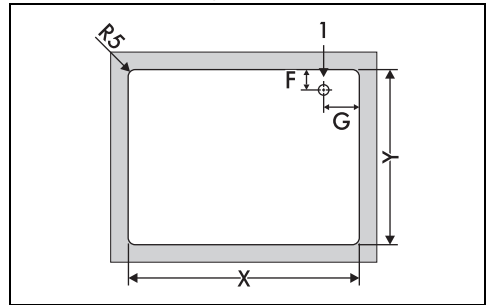

- X 916
- Y 500
- F 40
- G 57
- 1 Electrical connection

Appliance overall dimensions (mm)

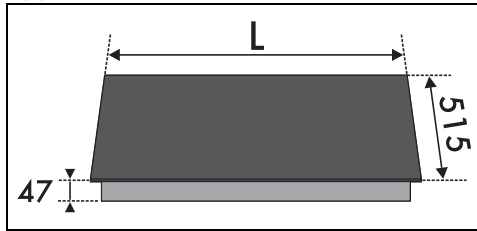

L 913

Built-in cabinet dimensions (mm)

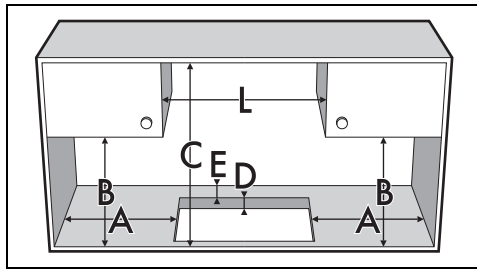

- A min. 50
- B min. 460
- C min. 750
- D 20 - 60
- E min. 50
- L 913

Hob seal

To prevent leakage of liquid between the frame of the hob and the countertop, place the adhesive seal provided along the entire outer

Flush Mounting (mm)

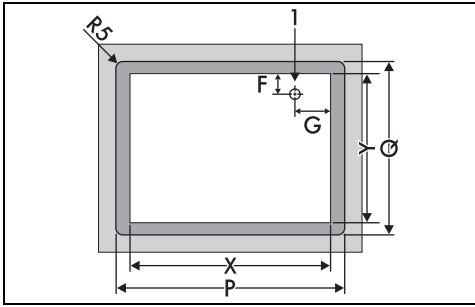

X 916

Y 500

P 934

Q 519

F 40

G 57

1 Electrical connection

Mounting

Over built-in oven unit

The clearance between the hob and the kitchen units or other built-in appliances must be enough to ensure sufficient ventilation and air discharge. If installed above an oven, a space must be left between the bottom of the hob and the top of the appliance installed below.

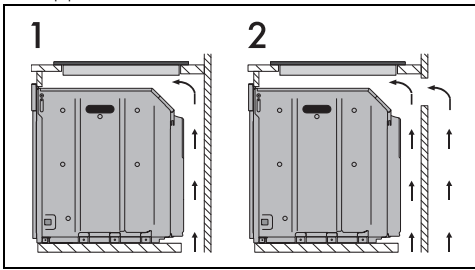

1 Opens on bottom

2 Opens on bottom and back

Proper ventilation

To ensure correct air circulation, there must be a minimum distance between the back of the appliance and the built-in cabinet (A) and between the bottom of the appliance and any

unit or appliance under it (B).

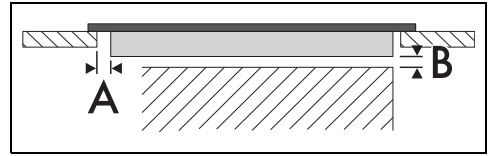

A min. 10 mm

B min. 2 mm

Instructions for the installer

Electrical connection instructions

- If you use a plug (if present) to connect to the power supply, the plug must be accessible after installation.
- Do not bend or trap the power cable.
- Use cables that are flexible and heat-resistant (e.g. SiHF-J).
- Place cable lugs on the ends of the wires before connecting to the induction generator.
- Keep the individual cables as short as possible inside the junction box (where present).
- Cables held together by cable clips should be kept as long as possible.
- Proper earthing and insulation is mandatory (verified by high voltage tests) in accordance with EN 50106.
- Increase the operating voltage gradually, not abruptly, to avoid damaging the appliance.

General instructions

- The appliance must be installed according to the installation diagrams.
- It is mandatory to carry out a functional test for the entire surface of the hob to make sure that the automatic pan detection system is working correctly.
- If the appliance does not work correctly after having carried out all the checks, contact your local Authorised Service Centre.
- Once the appliance has been installed, please explain to the user how to use it correctly.