

# Contents

<b>1 Instructions</b>	<b>50</b>
1.1 General safety instructions	50
1.2 Appliance purpose	56
1.3 Manufacturer's liability	56
1.4 This user manual	56
1.5 Identification plate	56
1.6 Disposal	57
1.7 How to read the user manual	58
1.8 To save energy	58
<b>2 Description</b>	<b>59</b>
2.1 General Description	59
2.2 Control panel	60
2.3 Other parts	61
2.4 Accessories	62
<b>3 Use</b>	<b>63</b>
3.1 Materials suitable for microwaves	64
3.2 Using the accessories	65
3.3 Using the oven	67
3.4 Cooking advice	78
3.5 Special functions	81
3.6 Settings	83
<b>4 Cleaning and maintenance</b>	<b>87</b>
4.1 Cleaning the surfaces	87
4.2 Cleaning the door	88
4.3 Cleaning the oven cavity	88
<b>5 Installation</b>	<b>90</b>
5.1 Electrical connection	90
5.2 Positioning	90

## TRANSLATION OF THE ORIGINAL INSTRUCTIONS

We advise you to read this manual carefully, which contains all the instructions for maintaining the appliance's aesthetic and functional qualities.

For further information on the product: [www.smeg.com](http://www.smeg.com)



## 1 Instructions

### IMPORTANT SAFETY INSTRUCTIONS PLEASE READ CAREFULLY AND RETAIN FOR FUTURE USE

#### 1.1 General safety instructions

##### RISK OF INJURY

- **ATTENTION:** If the door or the door seal is damaged, the appliance must not be used until it has been repaired by a competent person.
- **ATTENTION:** It is hazardous for anyone other than a competent person to carry out any service or repair operation which involves the removal of a cover which offers protection against exposure to microwave energy.
- **ATTENTION:** Liquids and other foods must not be heated in sealed containers since they are liable to explode.
- **ATTENTION:** During use, the appliance and its accessible parts become very hot. Never touch the heating elements during use.
- During use the appliance and its accessible parts become very hot. Never touch the heating elements during use.
- Protect your hands by wearing oven gloves when moving food inside the oven.
- Never try to put out a fire or flames with water: turn off the appliance and smother the flames with a fire blanket or other appropriate cover.
- This appliance may be used by children aged at least 8 and by people of reduced physical, sensory or mental capacity, or lacking in experience in the use of electrical appliances, provided that they are supervised or instructed by adults who are responsible for their safety.
- Children must not play with the appliance.



- Keep children under the age of 8 at a safe distance unless they are constantly supervised.
- Keep children under the age of 8 away from the appliance when it is in use.
- Cleaning and maintenance must not be carried out by unsupervised children.
- The cooking process must always be monitored. A short cooking process must be continuously surveyed.
- Never leave the appliance unattended during cooking operations where fats or oils could be released, as these could then heat up and catch fire. Be very careful.
- Do not pour water directly onto very hot trays.
- Keep the oven door closed during cooking.
- Do not insert pointed metal objects (cutlery or utensils) into the slots in the appliance.
- If you need to move food or at the end of cooking, open the door 5 cm for a few seconds, let the steam come out, then open it fully.
- Switch off the appliance immediately after use.
- DO NOT USE OR STORE FLAMMABLE MATERIALS NEAR THE APPLIANCE.
- DO NOT USE AEROSOLS IN THE VICINITY OF THIS APPLIANCE WHILST IT IS IN USE.
- DO NOT MODIFY THIS APPLIANCE.
- Installation and servicing should be carried out by qualified personnel in accordance with current standards.
- Do not try to repair the appliance yourself or without the assistance of a qualified technician.
- Do not pull the cable to unplug the appliance.



## Instructions

### USE OF MICROWAVES

- Check the appliance visually during the cooking of foods in plastic or paper containers.



### Improper use. Danger of explosion



- When using the microwave to heat or reheat liquids, the boiling process may be delayed – boiling temperature can be reached without the formation of the usual "rolling boil". This delayed boiling and consequent superheating of the liquid can generate an explosion inside the appliance, or sudden boiling over of the superheated liquid can occur when removing the container from the appliance. To avoid these dangers, it is necessary to insert the supplied boiling rod (or a heat-resistant plastic spoon) in the container while heating.

- Use the microwave only for the preparation of food for consumption. Other types of applications are strictly forbidden (e.g. drying clothes, warming slippers, sponges, wet cloths or the like, dehydrating foods) because they can lead to the risk of injury or fire.
- Clean the appliance constantly and remove any food residue.
- Do not use the microwave to dry food.
- Do not use the microwave to heat oils or fry.
- Do not use the appliance to heat foods or beverages containing alcohol.
- Do not heat eggs in their shells or whole hard boiled eggs; they may explode even after the heating process has completed.
- Do not heat food contained within food packages.



- Baby food should not be heated in sealed containers. Remove the cover or the teat (in the case of baby bottles). Always check the preparation's temperature once heating has completed, it should not be too high. For an even temperature and to avoid scalding stir or shake the contents.
- Before cooking food with a hard skin or peel (e.g. potatoes, apples, etc.) it is necessary to puncture the skin.
- Do not use the microwave functions when the oven is empty.
- Use cookware and utensils that are suitable for use in a microwave oven.
- Do not use aluminium containers to cook food.
- Do not use dishes with metallic decorations (gold-plated or silver).
- This appliance complies with the current standards and directives regarding safety and electromagnetic compatibility. It is however recommended for pacemaker wearers to maintain a minimum distance of 20-30 cm between the microwave when it is operating and the pacemaker. Consult the pacemaker manufacturer for more information.
- The appliance operates in the 2.4 GHz ISM band.
- In compliance with the provisions regarding electromagnetic compatibility, the appliance belongs to group 2 and class B (EN 55011).



## RISK OF DAMAGING THE APPLIANCE

- Do not use abrasive or corrosive detergents (e.g. scouring powders, stain removers and metallic sponges) on glass parts. Use wooden or plastic utensils.



## Instructions

- Do not use rough or abrasive materials or sharp metal scrapers.
- Do not sit on the appliance.
- Do not use cleaning products containing chlorine, ammonia or bleach on parts made of steel or that have metallic surface finishes (e.g. anodizing, nickel- or chromium-plating).
- Racks and trays should be inserted as far as they will go into the side guides. The mechanical safety locks that prevent them from being removed must face downwards and towards the back of the oven cavity.

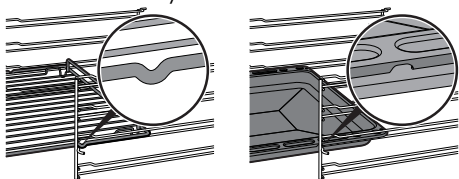

- Do not use steam jets to clean the appliance.
- Do not spray any spray product near the appliance.

- (on some models only) Before starting the pyrolytic cycle, remove any food residues or large spills from previous cooking operations from the inside of the oven.
- Do not obstruct ventilation openings and heat dispersal slots.
- Fire hazard: never leave objects in the oven cavity.
- **DO NOT FOR ANY REASON USE THE APPLIANCE AS A SPACE HEATER.**
- Do not use plastic cookware or containers when cooking food.
- Do not place sealed tins or containers in the oven cavity.
- Remove all trays and racks which are not required during cooking.
- Do not cover the bottom of the oven cavity with aluminium or tin foil sheets.
- Do not place pans or trays directly on the bottom of the oven cavity.



- If you wish to use greaseproof paper, place it so that it will not interfere with the hot air circulation inside the oven cavity.
- Do not use the open door to rest pans or trays on the internal glass pane.
- Never use the oven door to lever the appliance into place when fitting.
- Avoid exerting too much pressure on the door when open.
- Do not use the handle to lift or move this appliance.
- Do not install/use the appliance outdoors.
- To prevent any possible overheating, the appliance should not be installed behind a decoration door or a panel.
- Installation and servicing should be carried out by qualified personnel in accordance with current standards.
- Have the electrical connection performed by authorised technical personnel.
- The appliance must be connected to ground in compliance with electrical system safety standards.

## Installation and maintenance

- THIS APPLIANCE **MUST NOT BE INSTALLED** IN A BOAT OR CARAVAN.
- The appliance must not be installed on a pedestal.
- Position the appliance into the cabinet cut-out with the help of a second person.
- Use cables withstanding a temperature of at least 90 °C.
- The tightening torque of the screws of the terminal board leads must be 1.5 - 2 Nm.
- If the power cable becomes damaged, contact technical support immediately to arrange for it to be replaced in order to avoid possible hazards.



## Instructions

- Always use any necessary/required personal protective equipment (PPE) before performing any work on the appliance (installation, maintenance, positioning or movement).
- Before performing any operation on the appliance, switch off the power supply.
- This appliance can be used up to a maximum altitude of 2,000 metres above sea level.

### 1.2 Appliance purpose

This appliance is intended for cooking food in the home environment. Every other use is considered inappropriate. It cannot be used:

- in employee kitchens, shops, offices and other working environments.
- in farms/agritourism establishments.
- by guests in hotels, motels and residential environments.
- In bed and breakfast accommodation.

### 1.3 Manufacturer's liability

The manufacturer declines all liability for damage to persons or property caused by:

- use of the appliance other than that specified;
- failure to comply with the instructions in the user manual;
- tampering with any part of the appliance;
- use of non-original spare parts.

### 1.4 This user manual

- This user manual is an integral part of the appliance and must therefore be kept in its entirety and within the user's reach for the whole working life of the appliance.
- Read this user manual carefully before using the appliance.
- The explanations in this manual include images, which describe all that regularly appears on the display. However, it should be kept in mind that the appliance may be equipped with an updated version of the system, and as such, all that appears on the display may differ from those in the manual.

### 1.5 Identification plate

The identification plate bears the technical data, serial number and brand name of the appliance. Do not remove the identification plate for any reason.





## 1.6 Disposal



This appliance conforms to the WEEE European directive (2012/19/EU) and must be

disposed of separately from other waste at the end of its service life.

The appliance does not contain substances in quantities sufficient to be considered hazardous to health and the environment, in accordance with current European directives.

To dispose of the appliance:

- Cut the power cable and remove it.



**Power voltage**

**Danger of electrocution**

- Disconnect the mains power supply.
- Unplug the appliance.
- Deliver the appliance to the appropriate recycling centre for electrical and electronic equipment waste, or return it to the retailer when purchasing an equivalent product, on a one for one basis.

Our appliances are packaged in non-polluting and recyclable materials.

- Deliver the packing materials to the appropriate recycling centre.



**Plastic packaging**

**Danger of suffocation**

- Do not leave the packaging or any part of it unattended.
- Do not let children play with the plastic bags.



# Instructions

## 1.7 How to read the user manual

This user manual uses the following reading conventions:



### Instructions

General information on this user manual, on safety and final disposal.



### Description

Description of the appliance and its accessories.



### Use

Information on the use of the appliance and its accessories.



### Cleaning and maintenance

Information for proper cleaning and maintenance of the appliance.



### Installation

Information for the qualified technician: Installation, operation and inspection.



Safety instructions



Information/suggestion

## 1.8 To save energy

- Only preheat the appliance if the recipe requires you to do so.
- Unless otherwise indicated on the package, defrost frozen foods before placing them in the oven.
- When cooking several types of food it is recommended to cook the foods one after the other to make the best use of the already hot oven.
- Use dark metal moulds: They help to absorb the heat better.
- Remove all trays and racks which are not required during cooking.
- Stop cooking a few minutes before the time normally used. Cooking will continue for the remaining minutes with the heat which has accumulated inside the oven.
- Reduce any opening of the door to a minimum to avoid heat dispersal.
- Keep the inside of the oven clean at all times.



## 2 Description

### 2.1 General Description

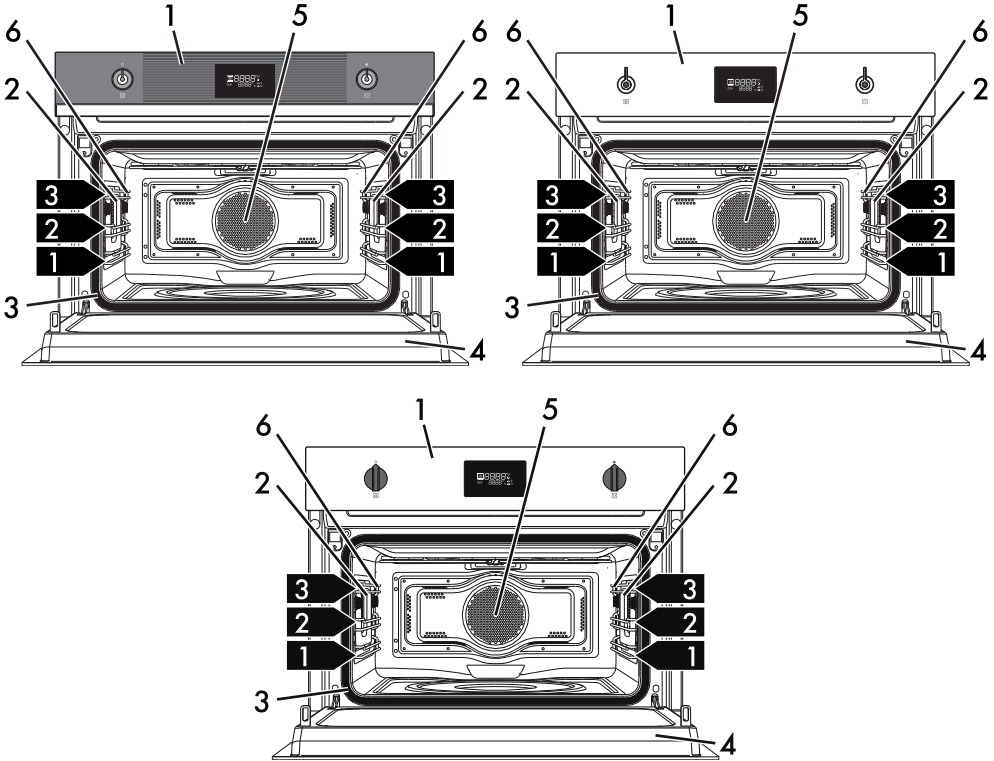

1 Control panel

2 Light bulb

3 Seal

4 Door

5 Fan

6 Rack/tray support frames

**1,2,3** Frame shelf



# Description

## 2.2 Control panel

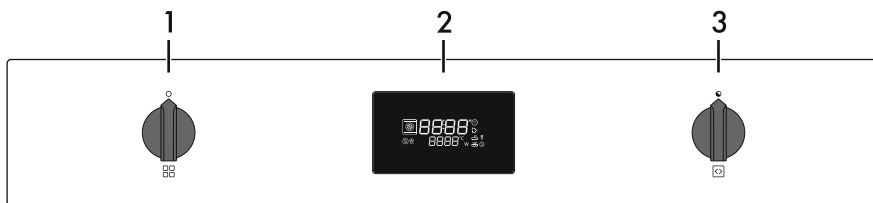
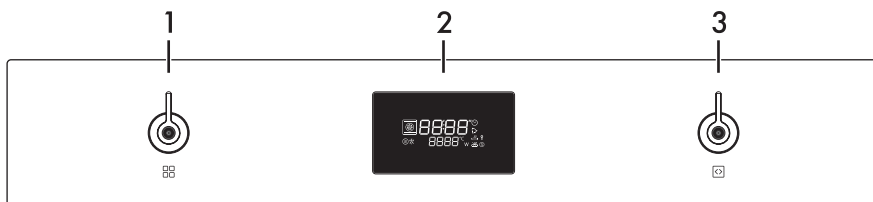
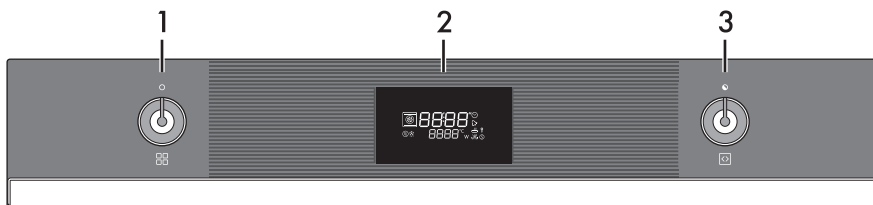

### 1 Function knob

This knob can be used to:

- Turn the appliance on and off;
- Select a function.



Turn the **Function knob**  to the position **0** to immediately complete any cooking operation.

### 3 Selection knob

This knob can be used to set:

- The cooking temperature;
- The duration of a function;
- Programmed cooking procedures;
- The current time;
- Temporarily start or stop a function.

## 2 Display

Displays the current time, the selected cooking temperature, power and function and any time set.



## 2.3 Other parts

### Interior lighting

The appliance's interior lighting comes on:

- when the door is opened;
- when any function is selected.



When the door is open, it is not possible to turn off the interior lighting.

### Shelves

The appliance features shelves to position trays and racks at different heights. The insertion heights are indicated from the bottom upwards (see **2.1 General Description**).

### Cooling fan

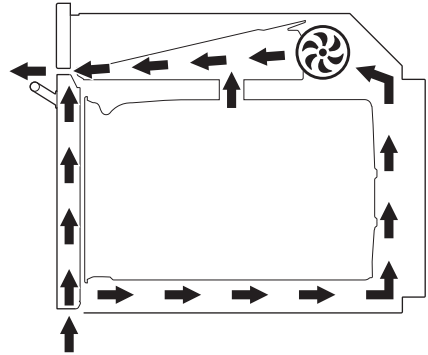

The fan cools the oven and comes into operation during cooking.

The fan causes a steady outflow of air from above the door which may continue for a brief period of time even after the appliance has been turned off.



## Description

### 2.4 Accessories

#### Rack

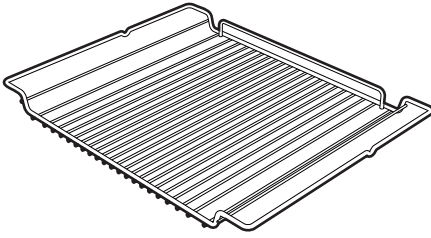

Used for supporting containers with food during cooking.

#### Glass dish

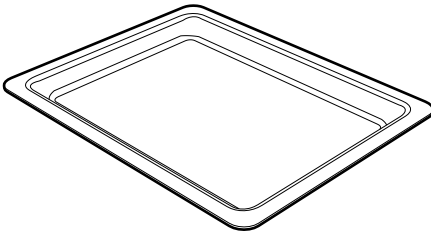

Useful for any type of cooking and collecting fat from foods placed on the rack above.

#### Tray rack

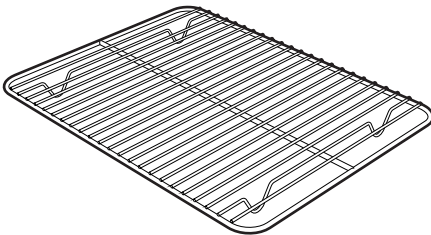

To be placed over the top of the oven tray; for cooking foods which may drip.

#### Boiling rod



To be placed in containers when heating liquids, necessary to avoid delayed boiling.



Not all accessories are available on some models.



The oven accessories intended to come into contact with food are made of materials that comply with the provisions of current legislation.



Original supplied and optional accessories can be requested to Authorised Assistance Centres. Use only original accessories supplied by the manufacturer.



### 3 Use

#### Instructions



High temperature inside the oven during use  
**Danger of burns**

- Keep the oven door closed during cooking.
- Protect your hands by wearing oven gloves when moving food inside the oven.
- Do not touch the heating elements inside the oven.
- Do not pour water directly onto very hot trays.
- Do not allow children to approach the oven when it is in operation.



Improper use  
**Risk of damage to enamelled surfaces**

- Do not cover the bottom of the oven cavity with aluminium or tin foil sheets.
- If you wish to use greaseproof paper, place it so that it will not interfere with the hot air circulation inside the oven cavity.
- Do not place pans or trays directly on the bottom of the oven cavity.
- Do not pour water directly onto very hot trays.



High temperature inside the oven during use  
**Danger of fire or explosion**

- Do not spray any spray product near the appliance.
- Do not use or leave flammable materials near the appliance.
- Do not use plastic cookware or containers when cooking food.
- Do not put sealed tins or containers in the oven.
- Do not leave the appliance unattended during cooking operations where fats or oils could be released.
- Remove all trays and racks which are not required during cooking.

#### Microwaves

The appliance is equipped with a microwave generator called a magnetron. The microwaves generated are evenly emitted into the oven cavity in order to reach the food and heat it.

Heating takes place through the process of friction between the molecules contained within the food (mainly water molecules), with the consequent generation of heat.

The heat generated directly inside the food allows defrosting, re-heating or cooking in a shorter length of time compared to traditional cooking.

The use of suitable containers for microwave cooking leads to the microwaves reaching the food in a uniform manner.



## Use

### 3.1 Materials suitable for microwaves

In general, in order for all of the food to be reached, the materials used for microwave cooking must be transparent to microwave energy.

Below is a table of materials to use and those not to use:

#### MATERIALS TO USE:

##### - Glass (always remove the lids) \*

- Baking ware
- Glasses
- Cans

##### - Porcelain

##### - Ceramic

##### - Plastic (only where suitable for microwave use) \*

- Containers
- Plastic wraps (must not come into contact with the food)

\*only if heat-resistant.

#### MATERIALS NOT TO USE:

##### - Metal (can lead to arcing or sparks)

- Aluminium foil
- Aluminium trays
- Plates
- Metal utensils
- Freezer bags tie wraps

##### - Wood

##### - Crystal glasses

##### - Paper (risk of fire)

##### - Polystyrene containers (danger of contamination of foodstuffs)



Dishes must be free of metal decorations.



Do not use metal accessory trays in the microwave or combined microwave functions.





## Testing dishes



The microwave function can be used without any food inside the oven only for this test.

To check whether or not cookware is suitable for use with microwave cooking carry out this simple test:

1. Remove all accessories from the oven cavity.
2. Place the crockery to be tested on the rack inserted in the first shelf.
3. Select the maximum power level (e.g. 1000 W).
4. Set a cooking time of 30 seconds.
5. Start cooking.



### Unsuitable cookware Risk of damage to the appliance

- If there is crackling or if sparks are emitted from the cookware then immediately terminate the test. In this instance the cookware is not suitable for microwave cooking.
6. At the end of the test the cookware must be either cold or slightly warm. If the cookware is hot then it should be considered as unsuitable for microwave use.

## Preliminary operations

1. Remove any protective film from the outside or inside of the appliance, including accessories.
2. Remove any labels (apart from the technical data plate) from the accessories and from the oven cavity.
3. Remove and wash all the appliance's accessories (see 4 Cleaning and maintenance).
4. Heat the empty oven at the maximum temperature to burn off any residues left by the manufacturing process.



For the first reheating use a traditional function and not a microwave function.

## 3.2 Using the accessories

### Tray rack

The tray rack has to be inserted into the tray. In this way fat can be collected separately from the food which is being cooked.

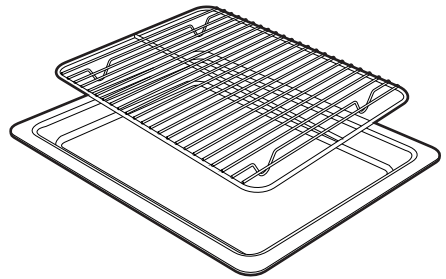



## Use

### Racks and trays

Racks and trays have to be inserted into the side guides until they come to a complete stop.

- The mechanical safety locks that prevent the rack from being taken out accidentally have to face downwards and towards the oven back.

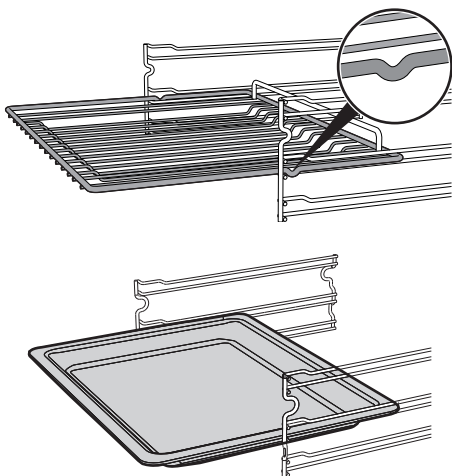

**High temperature.  
Danger of burns**

- The accessory gets very hot. Always use oven gloves when handling.



Gently insert racks and trays into the oven until they come to a stop.



Clean the trays before using them for the first time to remove any residues left by the manufacturing process.

### Boiling rod

When using the microwave to heat or reheat liquids, the boiling process may be delayed. To avoid this, place the boiling rod (or a heat-resistant plastic spoon) supplied into the container while heating.



**Improper use  
Danger of explosion/burns**

- To avoid the danger of explosion inside the appliance or the sudden boiling over of superheated liquids, it is always necessary to immerse the boiling rod in the liquid being heated.





**High temperature  
Risk of damage to the accessory**

- Use the boiling rod only with Microwave functions. The rod must not be used with combination and traditional functions.











### 3.3 Using the oven

#### Display





The parameters and values for the currently selected function will be indicated on the display. To use it, just turn the **Function**  and **Selection**  knobs to select the indicated values.



-  Clock indicator light
-  Timer indicator light
-  Cooking indicator light
-  Cooking end indicator light
-  Control lock indicator light
-  Showroom indicator light
-  Microwave indicator light
-  Defrost indicator light
-  Watt indicator light

#### First use

On the first use, or after a long power failure, the message **00:00** will flash on the appliance's display. To be able to start any cooking function, the current time must be set.

1. Turn the **Selection knob**  to select the current time.
2. Turn the **Selection knob**  to set the current time and go to the selection of minutes.
3. Turn the **Selection knob**  to select the minutes of the current time.
4. Press the **Selection knob**  to end the adjustment.



It may become necessary to change the current time, for example for daylight saving time. To change the current time, see "3.6 Settings".





When the current time is visible, after 2 minutes from the last knob operation it is displayed with low brightness.







## Timer



This function only operates the buzzer at the end of the countdown.

1. With the **Function Knob**  at position **0**, press the **Selection Knob** .



The display shows the digits  and the **minute minder indicator light**  flashes.



2. Within 3 seconds turn the **selection knob**  to set the duration of the **minute minder** (from 1 minute to 13 hours).
3. Wait 3 seconds or press the **selection knob**  to start the **minute minder**.







During the function, the display shifts to low brightness after 2 minutes from the last knob operation.

## End of the minute minder

4. At the end of the day the digits  and the **minute minder indicator light**  flash and a short buzzer intervenes, which can be deactivated by pressing the **selection knob**  or by opening the door.

5. Turn the **selection knob**  to select an additional minute minder or press the **selection knob**  to exit the **minute minder** function and return to the current time display.

## To delete a minute minder

1. Press the **selection knob** .
- The **minute minder indicator light**  on the display flashes.
2. Within 3 seconds, turn the **selection knob**  counter-clockwise until the minute minder value is reset.
  3. Wait 3 seconds or press the **selection knob**  to exit the **minute minder** function and return to the current time display.



## Warning



Improper use  
Risk of damage to the appliance

While using microwaves, the food must be placed in a suitable container resting on the rack inserted in the first runner.

**DO NOT USE CONTAINERS/ACCESSORIES (trays, glass trays, etc.) RESTING DIRECTLY ON THE BOTTOM OF THE OVEN CAVITY.**

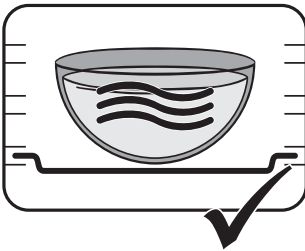
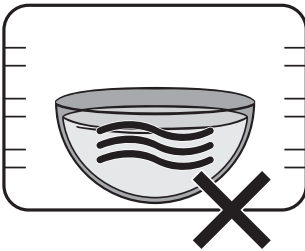



For perfect results with long microwave and combination cooking functions, food should be stirred once or twice during cooking.

## Selecting a microwave cooking function



## MICROWAVES

Given that they penetrate directly into the food, microwaves allow cooking to take place in a very short period of time and with a considerable saving of energy. They are suitable for cooking without fat and also for defrosting and re-heating food while maintaining its original appearance and fragrance.

1. Turn the **Function Knob**  to the right or left to select the "MICROWAVE " function.



2. Turn the **Selection knob**  to set the cooking duration (from 5 seconds to 30 minutes) (for example "5 minutes").







## Use

3. Press the **Selection knob** .



4. While the **Watt indicator light**  flashes, turn the **Selection knob**  to the right or to the left to change the power value from 100 W to 1000 W (see Microwave power levels) (for example "500 Watt").



5. Wait 3 seconds to start the cooking or press the **Selection knob**  to enter any setting of cooking duration, cooking end time...



### End of microwave cooking

6. At the end of the cooking time

**STOP** flashes on the display and a buzzer will sound that can be deactivated by opening the door and/or pressing/turning any of the two knobs.





### Microwave power levels

Below is a list of the power levels that can be selected:

Power (W)	Useful for
100	Defrosting food
200	
300	
400	Cooking meat or delicate cooking
500	
600	Re-heating and cooking food
700	
800	
900	Heating liquids
1000	



When the door is opened, the function in progress is interrupted (the **Cooking indicator light**  turns off). Once the door is closed, press the **Selection knob**  to resume cooking.



## Selecting a combination cooking function





**Improper use.  
Risk of damage to the appliance**

- Do not use the combination functions to heat or boil liquids.





Combination cooking is a mix of traditional cooking and microwave operation. These functions are indicated by the switching on of a traditional function symbol together with the microwave function indicator light .

- Turn the **Function knob**  to the right or to the left to select the wished function (for example "MICROWAVES + FAN-ASSISTED"  + ").



- Turn the **Selection knob**  to the right or to the left to select the wished temperature (for example "200 °C").





- Press the **Selection knob** .
- While the **Clock indicator light**  flashes, turn the **Selection knob**  to the right or to the left to change the cooking duration (from 1 minute to 13 hours) (for example "15 minutes").



- Press the **Selection knob** .



- While the **Watt indicator light**  flashes, turn the **Selection knob**  to the right or to the left to change the power value from 100 W to 600 W (see Microwave power levels) (for example "400 Watt").





- Press the **Selection knob**  to confirm the entered data.



## Use

8. Press the **Selection knob**  to start combination cooking.



When the door is opened, the function in progress is interrupted (the **Cooking indicator light**  turns off). Once the door is closed, press the **Selection knob**  to resume cooking.

### Pre-heating stage

Cooking itself is preceded by a preheating stage, which allows the appliance to heat to the cooking temperature more quickly.

The **Cooking indicator light**  flashes to indicate that this stage is in progress.

When the preheating stage is over, the

**Cooking indicator light**  will remain lit steadily and a buzzer will sound to indicate that the food can be placed inside the oven.



With the combination **MICROWAVES**  + **GRILL**



function, given the type of cooking and in order to cook more quickly, preheating is not performed.

### End of microwave cooking

9. At the end of the cooking time

**STOP** flashes on the display and a buzzer will sound that can be deactivated by opening the door and/or pressing/turning any of the two knobs.



### List of combined cooking functions



#### MICROWAVE + GRILL



The use of the grill results in perfect browning of the food's surface.

Using the microwave on the other hand leads to rapid internal cooking of the food.



#### MICROWAVE + FAN-ASSISTED



The operation of the fan, combined with traditional cooking, ensures consistent cooking even with complex recipes. Using the microwave on the other hand leads to rapid internal cooking of the food.



#### MICROWAVE + THERMO-VENTILATED







For combination cooking of food in a short time thanks to the microwave action working together with hot air circulation.





## Selecting a traditional cooking function

1. Turn the **Function knob**  to the right or to the left to select the wished function (for example "FAN-ASSISTED" - 2. Turn the **Selection knob**  to the right or to the left to select the wished temperature (for example "200 °C").
- 3. Wait 3 seconds to start the cooking or press the **Selection knob**  to enter any setting of cooking duration, cooking end time...



When the door is opened, the function in progress is interrupted (the **Cooking indicator light**  turns off).

The function resumes automatically when the door is closed.

## Pre-heating stage

Cooking itself is preceded by a preheating stage, which allows the appliance to heat to the cooking temperature more quickly.

The **Cooking indicator light**  flashes to indicate that this stage is in progress.

When the preheating stage is over, the

**Cooking indicator light**  will remain lit steadily and a buzzer will sound to indicate that the food can be placed inside the oven.



Cooking functions can be interrupted at any time by turning the **Function knob**  to the **0** position.

## Timed cooking



**Timed cooking** is the function which allows a cooking operation to be started and then ended after a specific length of time set by the user.





Activation of **timed cooking** cancels any minute minder timer which may previously have been set.

1. After selecting a cooking function and temperature, press the **selection knob** .



## Use

The display shows the digits **00:00** and the **Cooking indicator light**  and **Clock indicator light**  flash.



2. Within 3 seconds turn the **selection knob**  to set the cooking time (from 1 minute to 13 hours) (e.g. "25 minutes").



3. Wait 3 seconds.

The **Cooking indicator light**  stops flashing and the **Time-controlled cooking** starts.



**Time-controlled cooking** does not take into account the pre-heating time.

### End of time-controlled cooking

4. At the end of the cooking time

**STOP** flashes on the display and a buzzer will sound that can be deactivated by opening the door and/or pressing/turning any of the two knobs.





To select a further **time-controlled cooking**, turn again the **selection knob** .

### To delete a time-controlled cooking

1. Press the **selection knob** .

The **cooking indicator light**  on the display flashes.

2. Within 3 seconds, turn the **selection knob**  counter-clockwise until the cooking time is reset.

3. Wait 3 seconds or press the **selection knob**  to exit the **time-controlled cooking** function and return to the current time display.



## Minute minder during a cooking





This function only activates the buzzer, without stopping cooking.



It is not possible to set a **Minute minder during a cooking** if a **timed cooking** has already been set.

1. After selecting a cooking function and temperature, press the **selection knob**  twice.

The display shows the digits  and the **minute minder indicator light**  flashes.



You can also set a **Minute minder** also when cooking is in progress.



2. Within 3 seconds turn the **selection knob**  to set the duration of the **minute minder** (from 1 minute to 13 hours).
3. Wait 3 seconds.

The **minute minder indicator light**  stops flashing and the **minute minder** starts.

## End of minute minder during cooking

4. Wait for the buzzer to indicate that the time has finished.

The digits  and the **minute minder indicator light**  flash.

5. Turn the **selection knob**  to select additional minute minder or press the **selection knob**  to deactivate the buzzer and exit the **minute minder during cooking**.

After a few seconds, the display shows the current time and the cooking in progress continues.

## To delete a minute minder during cooking

1. During cooking, press the **selection knob**  twice.

The **minute minder indicator light**  on the display flashes.

2. Within 3 seconds, turn the **selection knob**  counter-clockwise until the minute minder value is reset.
3. Wait 3 seconds to exit the **minute minder function during cooking**.



# Use

## Programmed cooking



**Programmed cooking** is the function which allows a **time-controlled cooking** operation to be stopped automatically at an established time depending on the time set by the user, after which the appliance will switch off automatically.





For safety reasons, it is not possible to set the end of cooking time by itself without setting the cooking duration.



For safety reasons, **Programmed Cooking** cannot be set for **Microwave** and **Combined** functions.

1. After selecting a cooking function and temperature, press the **selection knob** .



The display shows the digits  and the **Cooking indicator light**  and **Clock indicator light**  flash.



2. Within 3 seconds turn the **selection knob**  to set the cooking time (from 1 minute to 13 hours) (e.g. "25 minutes").



3. Press the **Selection knob** .

The display shows the digits  and the **Cooking end indicator light**  and **Clock indicator light**  flash.

4. Turn the **selection knob**  within 3 seconds to set the end of cooking time (e.g. "13:15").



5. Wait 3 seconds.

The **cooking end indicator light**  remains on and the appliance waits for the set start time.



The minutes required for pre-heating are already included in the end-of-cooking time.





## End of set cooking

At the end of the cooking time **STOP** flashes on the display and a buzzer will sound that can be deactivated by opening the door and/or pressing/turning any of the two knobs.



## To delete a set cooking

1. Press the **selection knob** .

The **cooking indicator light**  on the display flashes.

2. Within 3 seconds, turn the **selection knob**  clockwise or counter-clockwise to set a new **Timed Cooking**. The **Set Cooking** has now been deleted.



Cooking functions can be interrupted at any time by turning the **Function knob**  to the **0** position.

## List of traditional cooking functions



### STATIC

Traditional cooking suitable for the preparation of one dish at a time. Ideal for cooking roasts, fatty meats, bread, stuffed cakes.



### FAN-ASSISTED

Intense and homogeneous cooking. Ideal for biscuits, cakes and multilevel cooking.



### GRILL

It allows to obtain excellent grilling and grating results. Used at the end of cooking, it gives a uniform browning to the dishes.



## Use



### ECO

ECO cooking: this function is particularly suitable for cooking on a single shelf with low energy consumption.

It is recommended for all types of food, excluding those that can create a lot of humidity (such as vegetables).

To obtain maximum energy savings and reduce cooking times, it is recommended to place food in the oven without preheating.



When using the **ECO** function, avoid opening the door during cooking.



Cooking times are longer with the **ECO** function.



The **ECO** function is a delicate cooking function and is recommended for food withstanding temperatures lower than 200 °C; in case of cooking at higher temperatures, select another function.



### TURBO

Allows quick cooking on multiple shelves without mixing the aromas. Perfect for large volumes that call for intense cooking.



For the **Turbo** function  see "3.5 Special functions".

## 3.4 Cooking advice

### General advice

- Use a fan assisted function to achieve consistent cooking at several levels.
- It is not possible to shorten cooking times by increasing the temperature (the food could be overcooked on the outside and undercooked on the inside).
- To prevent condensation from forming on the glass, hot food should not be left inside the oven for too long after cooking.



### Advice for cooking meat

- Cooking times vary according to the thickness and quality of the food and to consumer taste.
- Use a meat thermometer when roasting meat, or simply press on the roast with a spoon. If it is hard, it is ready; If not, it needs another few minutes cooking.
- For meat and potatoes, it is recommended from time to time to turn and/or mix the food to obtain a uniform browning on all sides.
- For low temperature cooking, brown the meat in a pan for a few minutes on all sides before baking in the oven.
- Microwave cooking is recommended for meat without layers of fat or nerve tissue on the surface.
- For meat roasts with combined microwave functions, it is recommended to turn the food so that it is evenly cooked and browned

### Advice for cooking with the Grill and the Fan with grill

- Meat can be grilled even when it is put into the cold oven or into the preheated oven if you wish to change the effect of the cooking.
- When using the fan-assisted with grill function, we recommend that you preheat the oven before grilling.
- We recommend placing the food at the centre of the rack.

### Advice for cooking desserts/pastries and biscuits

- Use dark metal moulds: They help to absorb the heat better.
- The temperature and the cooking time depend on the quality and consistency of the dough.
- To check whether the dessert is cooked right through: At the end of the cooking time, put a toothpick into the highest point of the dessert. If the dough does not stick to the toothpick, the dessert is cooked.
- If the dessert collapses when it comes out of the oven, on the next occasion reduce the set temperature by about 10 °C, selecting a longer cooking time if necessary.

### Advice for defrosting and proving

- Place frozen foods without their packaging in a lidless container on the first shelf of the oven.
- Avoid overlapping the food.
- To defrost meat, use the rack placed on the second level and a tray on the first level. In this way, the liquid from the defrosting food drains away from the food.
- The most delicate parts can be covered with aluminium foil.
- For successful proving, a container of water should be placed in the bottom of the oven.



# Use

## Cooking information table

Food	Weight (kg)	Function	Shelf	Temperature (°C)	Time (minutes)	
Lasagne	2.5	STATIC	1	220	60-65	
Pasta bake	2.0	STATIC	1	220	35-40	
Roasted veal	1.5	THERMO-VENTILATED MICROWAVE	1	200+300 W	55-60	
Pork loin	1.3	THERMO-VENTILATED MICROWAVE	1	190+300 W	40-45	
Spare ribs	0.9	TURBO	1	200	60-65	
Roast beef	0.9	THERMALLY-VENTILATED	1	200	55-60	
Roast rabbit	1.3	THERMO-VENTILATED MICROWAVE	1	200+300 W	58-62	
Turkey breast	2.3	THERMO-VENTILATED MICROWAVE	1	200+300 W	62-66	
					1 <sup>st</sup> surface	2 <sup>nd</sup> surface
Sausages	2.0	GRILL	3	250	16	12
Pork chops	0.8	TURBO	1	220	12	14
Bacon	0.4	GRILL	3	250	15	5
Trout (fresh)	0.8	THERMO-VENTILATED MICROWAVE	1	180+200 W	30-35	
Trout (frozen)	0.8	FAN-ASSISTED MICROWAVE	1	190+400 W	25-30	
Sea bass	0.6	THERMO-VENTILATED MICROWAVE	1	180+200 W	26-30	
Delicate fish	0.7	THERMO-VENTILATED MICROWAVE	1	180+200 W	30-34	
Roast potatoes	1.0	FAN-ASSISTED MICROWAVE	1	220+300 W	35-40	
Mixed vegetables	1.0	THERMO-VENTILATED MICROWAVE	1	200+500 W	20-25	
Pizza	1.0	FAN-ASSISTED	1-2	250	13-16	
Focaccia	1.0	FAN-ASSISTED	2	180	23-26	
Bread	0.5	THERMALLY-VENTILATED	1	200	45-50	
Meringues	0.2	TURBO	1	120	115-120	
Tart	1.0	STATIC	1	180	45-50	
Chiffon cake	0.6	THERMALLY-VENTILATED	1	160	30-35	
Brioches	0.5	THERMALLY-VENTILATED	1	160	50-55	
Ring cake	1.0	STATIC	1	160	55-60	
Sponge cake	0.7	THERMALLY-VENTILATED	1	160	70-75	
Profiteroles	0.3	TURBO	1	160	54-59	
Chocolate cake	1.0	THERMALLY-VENTILATED	1	160	48-52	

The times indicated in the table do not include preheating times and are provided only as a guide.





### 3.5 Special functions

#### Defrosting



This function allows you to defrost food on the basis of a selectable time.



1. Place the food inside the oven.
2. Turn the **function knob**  until the following text is displayed.





3. Press the **selection knob**  to confirm the use of the special functions. The **defrosting** function screen is displayed.





4. Press the **selection knob**  to start defrosting function.

The display shows the digits  and the **Microwave indicator light**  and **Defrosting indicator light**  flash.



5. Turn the **selection knob**  to set the **defrosting time** (from 5 seconds to 99 minutes) (for example "12 minutes and 30 seconds").
6. Wait 3 seconds or press the **selection knob**  to start defrosting.



When the door is opened, the function in progress is interrupted (the **Cooking indicator light**  turns off). Once the door is closed, press the **selection knob**  to resume defrosting.



## Use

### End of defrosting

At the end of **defrosting**, the flashing wording **STOP** is displayed and a buzzer will sound that can be deactivated by opening the door and/or pressing/turning any of the two knobs.



- Turn the **function knob** to position **0** to exit the function.

### TURBO function



Allows quick cooking on multiple shelves without mixing the aromas. Perfect for large volumes that call for intense cooking.

- Turn the **function knob** until the following text is displayed.



- Press the **selection knob** to confirm the use of the special functions.

The **defrosting** function screen is displayed.



- Turn the **selection knob** until the **TURBO** function is selected.



- Press the **selection knob** to confirm the **TURBO** function.
- Wait 3 seconds to start the function or press the selection knob to enter any setting of temperature, cooking duration, cooking end time...



- Turn the **function knob** to position **0** to exit the function.



### 3.6 Settings

#### Current time

1. Turn the **function knob**  until the following text is displayed.



2. Press the **selection knob**  to enter the **settings** list.

The **current time** function screen is displayed.



3. Press the **selection knob**  to start adjusting the current time (e.g. "12:30").



4. Turn the **selection knob**  to select the current time.



5. Turn the **selection knob**  to set the current time and go to the selection of minutes.



6. Turn the **selection knob**  to select the minutes of the current time.



7. Press the **selection knob**  to end the adjustment.



8. Turn the **selection knob**  for a new setting.



## Use

### Control lock (children safety)



This mode allows the appliance to lock the controls automatically after one minute of normal operation without any intervention from the user.

1. Turn the **function knob**  until the following text is displayed.



2. Press the **selection knob**  to enter the **settings** list.

The **current time** function screen is displayed.





3. Turn the **selection knob**  until the **Control lock** function is selected.



4. Press the **Selection knob**  to confirm.

5. Turn the **selection knob**  to activate the **control lock** function.



6. Press the **selection knob**  to confirm.
7. Turn the **selection knob**  for a new **setting**.



In normal operation, the **control lock** is indicated by the  **Control lock indicator** light coming on.



Touching or varying the position of the temperature and function knobs, the display will show **bLOC** for two seconds.



To temporarily release the lock during cooking, hold the selection knob  pressed for 5 seconds. One minute after the last setting the lock will become active again.



## Showroom (for exhibitors only)



This mode allows the appliance to deactivate all heating elements, while keeping the control panel active.

1. Turn the **function knob**  until the following text is displayed.





2. Press the **selection knob**  to enter the **settings** list.

The **current time** function screen is displayed.





3. Turn the **selection knob**  until the **show room** function is selected.



4. Press the **selection knob**  to confirm.
5. Turn the **selection knob**  to activate the **show room** function.



6. Press the **selection knob**  to confirm.
7. Turn the **selection knob**  for a new **setting**.



The active **show room** is indicated on the display by the  lit **Show Room** indicator light.



To use the appliance normally, set this function to **OFF**.



# Use

## Keep warm



This mode allows the appliance after cooking finishes with a cooking cycle for which a duration has been set (if this is not manually interrupted), to keep cooked food warm (at low temperatures) without altering the taste and aromas obtained during cooking.

1. Turn the **function knob**  until the following text is displayed.





2. Press the **selection knob**  to enter the **settings** list.

The **current time** function screen is displayed.





3. Turn the **selection knob**  until the **keep warm** function is selected.



4. Press the **selection knob**  to confirm.
5. Turn the **selection knob**  to activate the **show room** function.



6. Press the **selection knob**  to confirm.
7. Turn the **selection knob**  for a new **setting**.



To use the appliance normally, set this function to **OFF**.



## 4 Cleaning and maintenance

### Instructions



High temperature inside the oven after use

#### Danger of burns

- Perform cleaning only after letting the appliance cool down.



Improper use

#### Risk of damage to surfaces

- Do not use steam jets to clean the appliance.
- Do not use cleaning products containing chlorine, ammonia or bleach on parts made of steel or that have metallic surface finishes (e.g. anodizing, nickel- or chromium-plating).
- Do not use abrasive or corrosive detergents (e.g. scouring powders, stain removers and metallic sponges) on glass parts.
- Do not use rough or abrasive materials or sharp metal scrapers.
- Failure to clean the oven could adversely affect the life of the appliance and pose a hazard.
- Always remove food residues from the oven cavity.



Improper use.

#### Danger of explosion/burns

- Do not use detergents with high alcohol content or which can release inflammable vapours. Subsequent heating could set off an explosion inside the appliance.



If a lamp is damaged, contact Technical support for a replacement. This fault will not affect the integrity of the appliance which can continue to be used.

### 4.1 Cleaning the surfaces

To keep the surfaces in good condition, they should be cleaned regularly after use. Let them cool first.

#### Ordinary daily cleaning

Always and only use specific products that do not contain abrasives or chlorine-based acids.

Pour the product onto a damp cloth and wipe the surface, rinse thoroughly and dry with a soft cloth or a microfibre cloth.



# Cleaning and maintenance

## Food stains or residues

Do not use steel sponges and sharp scrapers as they will damage the surface.

Use normal, non-abrasive products and a wooden or plastic tool, if necessary. Rinse thoroughly and dry with a soft cloth or a microfibre cloth.

Do not allow residues of sugary foods (such as jam) to set inside the oven. If left to set for too long, they might damage the enamel lining of the oven.

## 4.2 Cleaning the door

### Cleaning the door glazing

The glass in the door should always be kept thoroughly clean. Use absorbent kitchen roll. In case of stubborn dirt, wash with a damp sponge and an ordinary detergent.



We recommend the use of cleaning products distributed by the manufacturer.

## 4.3 Cleaning the oven cavity

In order to keep your oven in the best possible condition, clean it regularly after letting it cool down.

Avoid letting food residue dry inside the oven cavity, as this could damage the enamel.

Take out all removable parts before cleaning.

For easier cleaning, it is recommended to remove:

- the door
- The rack/tray support frames



In the event you are using specific cleaning products, we recommend running the oven at maximum temperature for 15-20 minutes in order to eliminate any residue.

## Drying

Cooking food generates moisture inside the appliance. This is a normal phenomenon and does not affect the appliance's operation in any way.

Each time you finish cooking:

1. Let the appliance cool down.
2. Remove any dirt from inside the appliance.
3. Dry the interior of the appliance with a soft cloth.
4. Leave the door open until the inside of the appliance has dried completely.





## Removing racks/trays support frames

Removing the guide frames enables the sides to be cleaned more easily.

To remove the guide frames:

1. Unscrew the frame fastening pins:

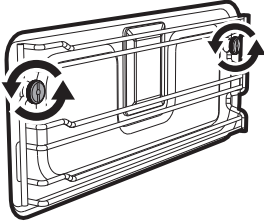

2. Pull the frame towards the inside of the oven to free it from the fastening pins.

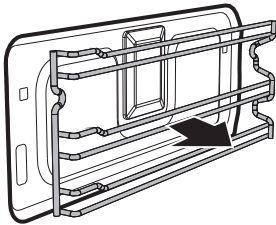

3. When cleaning is complete, repeat the above procedures to put the guide frames back in. Pay attention to the spacer bushings which need to be inserted correctly into the frames.

## Seal maintenance tips

The seal should be soft and elastic.

- To keep the seal clean, use a non-abrasive sponge and wash with lukewarm water.

## Cleaning the top section



**High temperature inside the oven during use**  
**Danger of burns**

- The following operations must be carried out only with the oven completely cold and turned off.

The appliance is equipped with a tilting grill element that allows for easy cleaning of the upper part of the oven cavity.

1. Free the upper heating element by gently lifting it and rotating its retaining latch by 90 degrees.

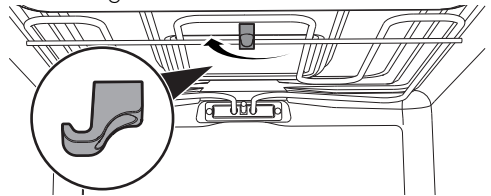

2. Gently lower the heating element until it stops.

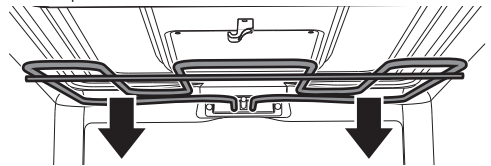

**Improper use**  
**Risk of damage to the appliance**

- Do not excessively flex the element during cleaning.

3. When you have finished cleaning, place the heating element back in position and turn the retaining latch to lock it in place.



# Installation

## 5 Installation

### 5.1 Electrical connection



**Power voltage**  
**Danger of electrocution**

- Have the electrical connection performed by authorised technical personnel.
- The appliance must be connected to ground in compliance with electrical system safety standards.
- Disconnect the mains power supply.

#### General information

Check the mains characteristics against the data indicated on the plate.

The identification plate bearing the technical data, serial number and brand name is visibly positioned on the appliance.

Do not remove this plate for any reason. The appliance works at 220-240 V~.

Use a three-pole cable (3 x 1.5 mm<sup>2</sup> internal conductors).

Perform the ground connection using a wire that is 20 mm longer than the other wires.

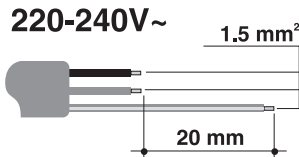

#### Connection with plug and socket

Make sure that the plug and socket are of the same type.

Avoid using adapters, gang sockets or shunts as these could cause overheating and a risk of burns.

#### Fixed connection

Fit the power line with an all-pole circuit breaker with a contact separation distance sufficient to provide complete disconnection in category III over voltage conditions, pursuant to installation regulations.

#### Testing

At the end of installation, carry out a brief inspection test. If the hob fails to operate, after checking that you have carried out the instructions correctly, unplug the appliance and contact Technical Support.

#### Cable replacement



**Power voltage**  
**Danger of electrocution**

- Disconnect the mains power supply.

1. Unscrew the rear casing screws and remove the casing to access the terminal board.
2. Replace the cable.
3. Make sure that the cables (for the oven or any hob) follow the best route in order to avoid any contact with the appliance.

### 5.2 Positioning



**Heavy appliance**  
**Crushing hazard**

- Position the appliance into the cabinet cut-out with the help of a second person.



## Pressure on the open door Risk of damage to the appliance

- Never use the oven door to lever the appliance into place when fitting.
- Avoid exerting too much pressure on the door when open.



## Heat production during appliance operation Risk of fire

- Make sure that the cabinet material is heat resistant.
- Check that the cabinet has the required slots.
- Do not install the appliance in a recess which can be closed with a door, or in a cupboard.

## Position of the power cable

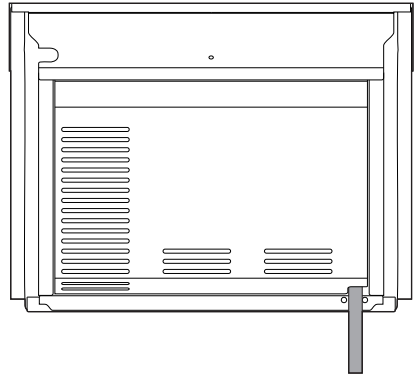

(rear view)

## Front panel seal

Glue the supplied seal to the rear part of the front panel to avoid water or other liquids from leaking in.

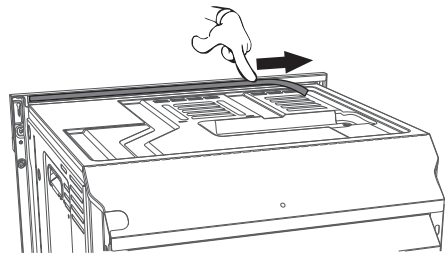

EN



# Installation

## Fastening bushings

Remove the bushing covers on the front of the oven.

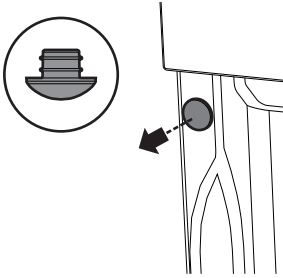

Mount the appliance into the recess.  
Secure the appliance to the cabinet using screws.

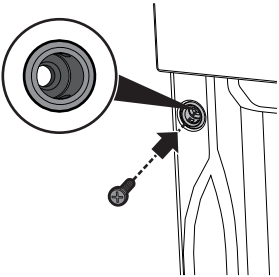

Cover the bushings with the previously removed covers.

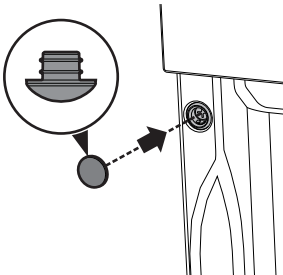

## Appliance overall dimensions (mm)

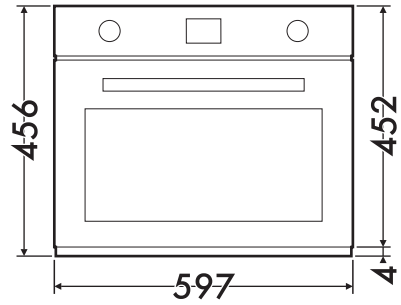

(front view)

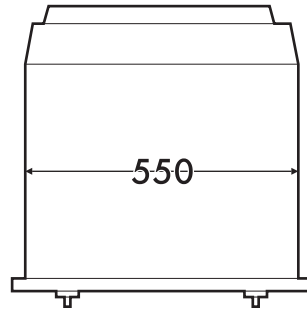

(top view)



## Mounting under worktops (mm)

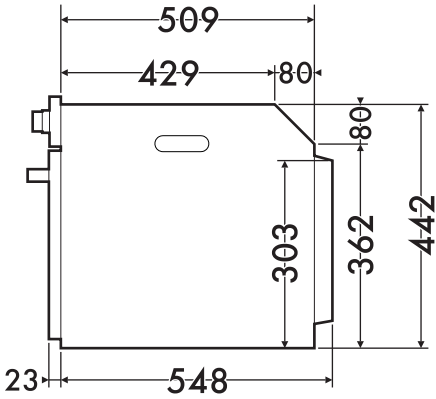

(side view)

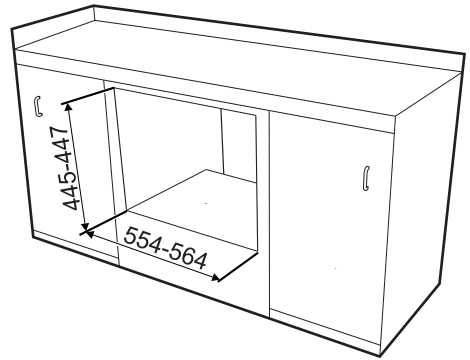
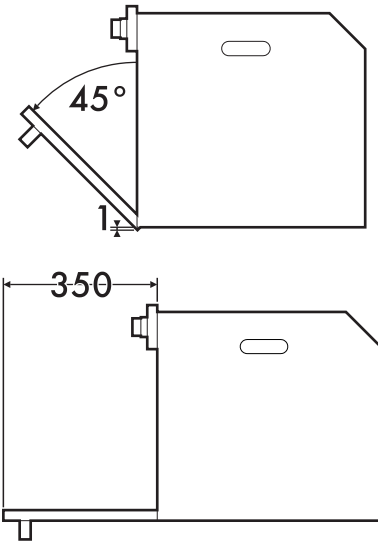

EN

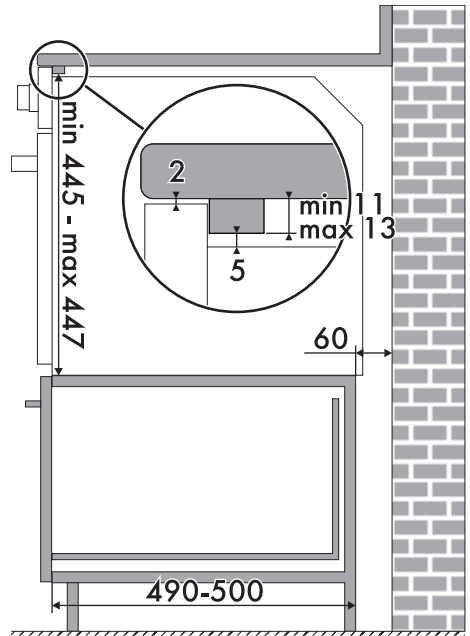

Make sure that the carcass rear/bottom section has an opening of approx. 60 mm.



# Installation

## Mounting into a column (mm)

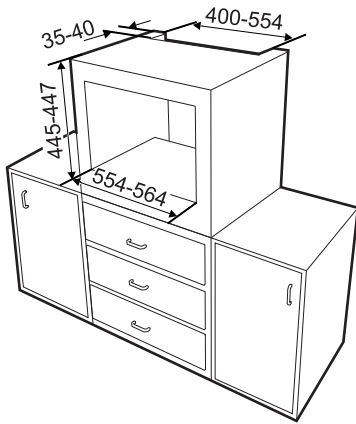

Make sure that the carcass top/rear section has an opening approx. 35-40 mm deep.

