

Contents

1	Instructions	4
1.1	General safety instructions	4
1.2	Manufacturer liability	5
1.3	Disposal	6
1.4	Identification plate	6
1.5	This user manual	6
1.6	How to read the user manual	6
2	Description	7
2.1	General Description	7
2.2	Symbols	7
2.3	Available accessories	7
3	Use	8
3.1	Instructions	8
3.2	First use	8
3.3	Using the hob	8
4	Cleaning and maintenance	11
4.1	Instructions	11
4.2	Cleaning the appliance	11
5	Installation	13
5.1	Important notes	13
5.2	Safety instructions	13
5.3	Section cut from the work surface	14
5.4	Mounting	14
5.5	Fixing brackets	15
5.6	Gas connection	16
5.7	Electrical connection	18
5.8	Instructions for the installer	19

These instructions apply only for the destination countries listed on the appliance's data plate.

This is a class 3 built in hob.

We advise you to read this manual carefully, which contains all the instructions for maintaining the appliance's aesthetic and functional qualities.

For further information on the product: www.smeg.com



Instructions

1 Instructions

1.1 General safety instructions

Risk of personal injury

- Never try to put out a fire or flames with water: turn off the appliance and smother the flames with a fire blanket or other appropriate cover.
- Make sure that the flame-spreader crowns are correctly positioned in their seats with their respective burner caps.
- Be aware of how rapidly the cooking zones heat up. Do not place empty pans on the heat. Danger of overheating.
- Fats and oils can catch fire if they overheat. Do not leave the appliance unattended while preparing foods containing oils or fats. If fats or oils catch fire, never put water on them. Place the lid on the pan and turn off the relevant cooking zone.
- Cooking process should always be kept under control. A short cooking process must be continuously surveyed.
- While cooking do not place metal objects, such as cutlery or dishes on the hob surface as they may overheat.
- Do not pour water directly on very

hot trays.

- Do not use aerosols in the vicinity of this appliance whilst it is in use.
- Switch off the appliance after use.
- Do not modify this appliance.
- Do not try to repair the appliance yourself or without the intervention of a qualified technician.
- Do not pull the cable to remove the plug.
- If the power supply cable is damaged, contact technical support immediately and they will replace it.

Risk of damaging the appliance

- Do not use steam jets to clean the appliance.
- Do not use rough or abrasive materials or sharp metal scrapers.
- Do not use cleaning products containing chlorine, ammonia or bleach on parts made of steel or that have metallic surface finishes (e.g. anodizing, nickel- or chromium-plating).
- Do not use abrasive or corrosive detergents (e.g. scouring powders, stain removers and metallic sponges) on glass parts.
- Do not wash the removable components such as the hob grids, flame-spreader crowns and burner caps in a dishwasher.



- Maximum load weight for this hob is 15 kg.
- Do not use oversized utensils for cooking, utensil size should be less than 26 cm.
- The appliance must be connected to ground in compliance with electrical system safety standards.
- Use cables withstanding a temperature of at least 90°C.

Installation

- This appliance **must not be installed** in a boat or caravan.
- This appliance must not be installed on a pedestal.
- Before any operation on the appliance (installation, maintenance, positioning or movement) always wear PPM (Personal Protective Measure).
- Before performing any operation on the appliance, switch off the power supply.
- Installation using a hose must be carried out so that the length of the hose does not exceed 2 metres when fully extended for steel hoses and 1.5 metres for flexible tubing.
- The hoses should not come into contact with moving parts and should not be crushed in any way.
- After carrying out any operation, check that the tightening torque of gas connections is between 10 Nm and 15 Nm.
- At the end of the installation, check for any leaks with a soapy solution, never with a flame.
- The tightening torque of the screws of the terminal board leads must be 1.5 - 2 Nm.
- ATTENTION! According to the Gas Safety Ordinance of Hong Kong, any gas installation works including the installation of appliances and connection tubing, must be undertaken by registered gas installers who are registered for that appropriate classes and be employed by registered gas contractors.
- Use approved gas tubing bearing EMSD approval marking (such as : 機電工程署批准EMSD APPROVAL GTXXXX) for connection to appliances, or other appropriate methods accepted by EMSD.

1.2 Manufacturer liability

The manufacturer declines all liability for damage to persons or property caused by:

- use of the appliance other than the one envisaged,
- failure to comply with the instructions in the user manual,
- tampering with any part of the



Instructions

appliance,

- use of non-original spare parts.

1.3 Disposal

To dispose of the appliance:



Power voltage

Danger of electrocution

- Disconnect the mains power supply.
 - Unplug the appliance.
-
- Cut the power supply cable and remove it along with the plug.



Plastic packaging

Danger of suffocation

- Do not leave the packaging or any part of it unattended.
- Do not let children play with the packaging plastic bags.

1.4 Identification plate

The identification plate bears the technical data, serial number and brand name of the appliance. Do not remove the identification plate for any reason.

1.5 This user manual

This user manual is an integral part of the appliance and must therefore be kept in its entirety and within the user's reach for the whole working life of the appliance. Read this user

manual carefully before using the appliance.

1.6 How to read the user manual

This user manual uses the following reading conventions:

Instructions



General information on this user manual, on safety and final disposal.

Description



Description of the appliance and its accessories.

Use



Information on the use of the appliance and its accessories.

Cleaning and maintenance



Information for proper cleaning and maintenance of the appliance.

Installation



Information for the qualified technician: Installation, operation and inspection.



Safety instructions



Information



Advice

1. Sequence of instructions for use.

- Standalone instruction.



2 Description

2.1 General Description

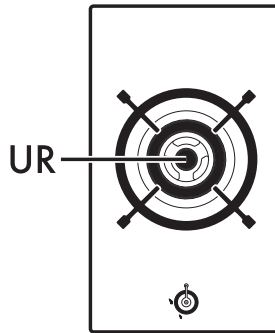





30 cm

UR = Ultra rapid burner

2.2 Symbols

Burner knob

Useful for lighting and adjusting the hob burner. Press and turn the knob anti-clockwise to the value  to light the relative burner. Turn the knob to the zone between the maximum  and minimum  setting to adjust the flame. Return the knob to the  position to turn off the burner.

2.3 Available accessories

WOK ring

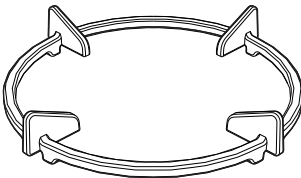

Useful when using a wok.



3 Use

3.1 Instructions



Improper use Danger of burns

- Make sure that the flame-spreader crowns are correctly positioned in their housings with their respective burner caps.
- Oils and fats could catch fire if overheated. Be very careful.
- Do not leave the appliance unattended during cooking operations where fats or oils could be released.
- Do not spray any spray products near the appliance.
- Do not touch the appliance's heating elements when it is running. Leave them to cool before cleaning.
- Do not allow children younger than 8 years old to come near the appliance when in operation.



Improper use Risk of damage to surfaces

- Do not use aluminium foil to cover the burners or hob body.
- Cooking vessels or griddle plates should be placed inside the perimeter of the hob.
- All pans must have smooth, flat bottoms.
- If any liquid does boil over or spill, remove the excess from the hob.
- It is not advisable to use earthenware or stoneware pans to cook or heat food.

3.2 First use

1. Remove any protective film from the outside or inside of the appliance, including accessories.
2. Remove any labels (apart from the technical data plate) from accessories.
3. Remove and wash all the appliance accessories (see 4 Cleaning and maintenance).

3.3 Using the hob

All the appliance's control and monitoring devices are located together on the front panel. The burner controlled by each knob is shown next to the knob. The appliance is equipped with an electronic ignition device. Simply press the knob and turn it anti-clockwise to the maximum flame symbol, until the burner lights. If the burner does not light in the first 15 seconds, turn the knob to  and wait 60 seconds before trying again. After lighting, keep the knob pressed in for a few seconds to allow the thermocouple to heat up.

The burner may go out when the knob is released: In this case, the thermocouple has not heated up sufficiently. Wait a few moments and repeat the operation. Keep the knob pressed in longer.



In case of an accidental switching off, a safety device will be tripped, cutting off the gas supply, even if the gas tap is open. Return the knob to  and wait at least 60 seconds before lighting it again.



Correct positioning of the grids

Under the grids there are silicone rests with a hole that must be centred onto the matching fixing pins on the surface.

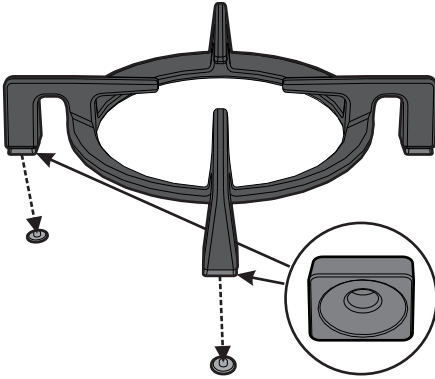

Make sure that the grids are simply centred on their respective burners, without forcing the burners to be raised or tilted. If they are, repeat the positioning procedure.

If you find that a pan is particularly unstable, make sure that the grids have not been positioned incorrectly.

Ring reducers

The ring reducers must be rested on the hob grid.

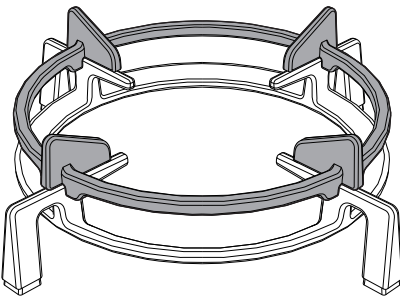

Correct positioning of the flame-spreader crowns and burner caps

Before lighting the hob burners, check that the flame-spreader crowns are correctly in place with their respective burner caps, making sure that the holes (A) in the burner are aligned with the igniters and thermocouples (B). Make sure they are properly positioned. Wrong placement may cause deform of the spreader crowns and burner caps, or break the glass, or increase the risk of releasing carbon monoxide (CO).

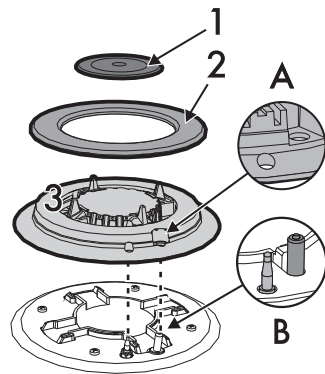

- 1 - Burner cap internal (UR)
- 2 - Burner cap external (UR)
- 3 - Flame spreader crowns



Practical tips for using the hob

For better burner efficiency and to minimise gas consumption, use pans with lids and of suitable size for the burner, so that flames do not reach up the sides of the pan. Once the contents come to the boil, turn down the flame far enough to ensure that the liquid does not boil over.



Cookware diameters:

- **UR:** 12 - 26 cm

To prevent burns or damage to the hob or the counter top during cooking, all pans or griddles (not provided) must be placed inside the perimeter of the hob.

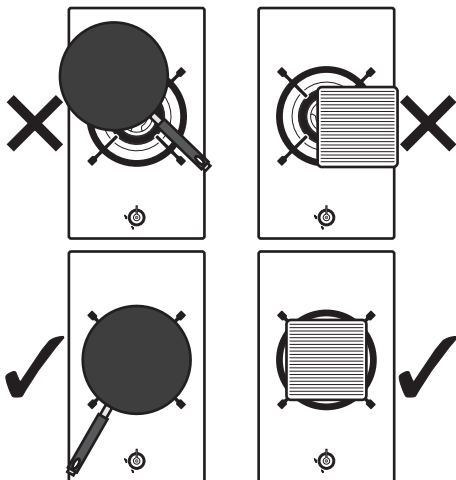



4 Cleaning and maintenance

4.1 Instructions



Improper use Risk of damage to surfaces

- Do not use steam jets to clean the appliance.
- Do not use cleaning products containing chlorine, ammonia or bleach on steel parts or parts with metallic finishes on the surface (e.g. anodizing, nickel- or chromium-plating).
- Do not use abrasive or corrosive detergents on glass parts (e.g. powder products, stain removers and metallic sponges).
- Do not use rough or abrasive materials or sharp metal scrapers.
- Do not wash the removable components such as the hob grids, flame-spreader crowns and burner caps in a dishwasher.

4.2 Cleaning the appliance

To keep the surfaces in good condition, they should be cleaned regularly after use. Let them cool first.

Ordinary daily cleaning

Always use only specific products that do not contain abrasives or chlorine-based acids.

Pour the product onto a damp cloth and wipe the surface, rinse thoroughly and dry with a soft cloth or a microfibre cloth.

Food stains or residues

Do not use metallic sponges or sharp scrapers as they will damage the surfaces.

Use ordinary non-abrasive products with the aid of wooden or plastic utensils if necessary. Rinse thoroughly and dry with a soft cloth or a microfibre cloth.

Do not allow residues of sugary foods (such as jam) to set inside the oven. If left to set for too long, they might damage the enamel lining of the oven.

Cooking hob grids

Remove the grids and clean them with lukewarm water and non-abrasive detergent. Make sure to remove any encrustations. Dry them thoroughly and return them to the hob.



Continuous contact between the grids and the flame can cause modifications to the enamel over time in those parts exposed to heat. This is a completely natural phenomenon which has no effect on the operation of this component.



Cleaning and maintenance

Flame-spreader crowns and burner caps

For easier cleaning, the flame-spreader crowns and the burner caps can be removed. Wash them in hot water and non-abrasive detergent. Carefully remove any encrustation, then wait until they are perfectly dry. Refit the flame-spreader crowns making sure that they are correctly positioned in their housings with their respective burner caps.

Igniters and thermocouples

For correct operation the igniters and thermocouples must always be perfectly clean. Check them frequently and clean them with a damp cloth if necessary. Remove any dry residues with a wooden toothpick or a needle.

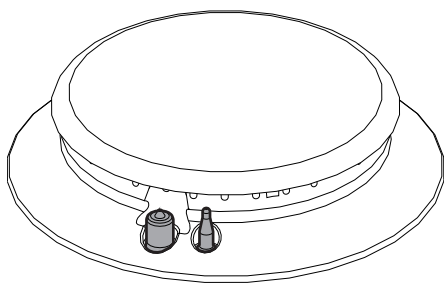

Knobs



Do not use aggressive products containing alcohol or products for cleaning steel and glass when cleaning the knobs, as these products could cause permanent damage.

The knobs should be cleaned with a soft cloth dampened with warm water, then dried carefully. They can easily be removed by pulling them upwards.

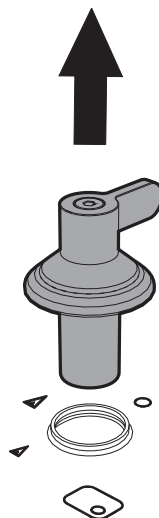



5 Installation

5.1 Important notes

Read these instructions carefully and keep them in a safe place. Safety during use can only be ensured if the appliance is fitted correctly according to these installation instructions. The registered gas installer is responsible for ensuring that the appliance operates perfectly at the point of installation.

ATTENTION! According to the Gas Safety Ordinance of Hong Kong, any gas installation works including the installation of appliances and connection tubing, must be undertaken by registered gas installers who are registered for that appropriate classes and be employed by registered gas contractors.

Use approved gas tubing bearing EMSD approval marking (such as 機電工程署批准 EMSD APPROVAL GTXXXX) for connection to appliances, or other appropriate methods accepted by EMSD.

Before carrying out any type of work, turn off the electricity and gas supply.

For installation, currently applicable building regulations and the regulations of local electricity and gas suppliers must be observed.

For town gas connection, the external gas governor (MAXITROL model no. RV47LM-Rp-1/2") must be installed.

5.2 Safety instructions



**Heat production during appliance operation
Risk of fire**

- Check that the piece of furniture material is heat resistant.
- Check that the piece of furniture has the required slots.

Veneers, adhesives or plastic coatings on adjacent furniture should be temperature-resistant (>90°C), otherwise they might warp over time.



The minimum clearance between a ventilation hood and the cooking surface must be at least the distance indicated in the ventilation hood installation instructions.

The minimum clearances must also be respected for the edges of the hob on the back as indicated in the mounting illustrations.



Installation

5.3 Section cut from the work surface

i The following operation requires building and/or carpentry work and must therefore be carried out by a competent tradesman.

Installation can be carried out on various materials such as masonry, metal, solid wood or plastic laminated wood as long as they are heat resistant (>90°C).

Create an opening with the dimensions shown in the figure in the work surface of the piece of furniture.

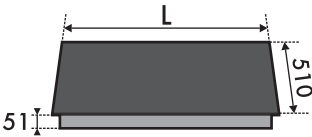

L (mm)	X (mm)	Y (mm)
300	252 - 256	478 - 482

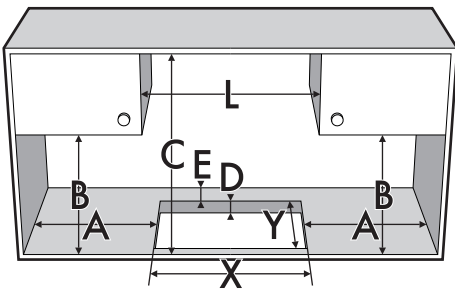

A (mm)	B (mm)	C (mm)*	D (mm)	E (mm)
min 150	min 460	min 750	20 - 60	min 50

*If there is a piece of furniture above the hob. In case of hood, refer to the values on the dedicated manual.

5.4 Mounting

Over built-in oven

The clearance between the hob and the kitchen furniture or other installed appliances must be enough to ensure sufficient ventilation and air discharge.

If installed above an oven, a space must be left between the bottom of the hob and the top of the appliance installed below.

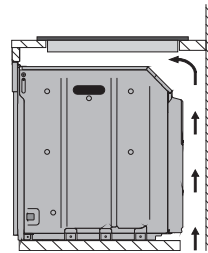

opens on bottom

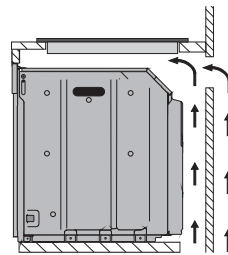

opens on bottom and on rear



If installed on top of an oven, the latter must be equipped with a cooling fan.



Over empty kitchen unit or drawers

If there are other pieces of furniture (lateral walls, drawers, etc.), dishwashers or fridges under the hob, a double-layer wooden base must be installed at least **10 mm** from the bottom of the hob to avoid any accidental contact. It must only be possible to remove the double-layer base using suitable equipment.

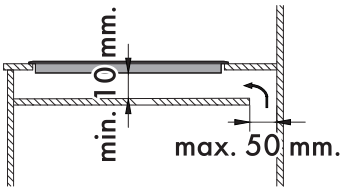
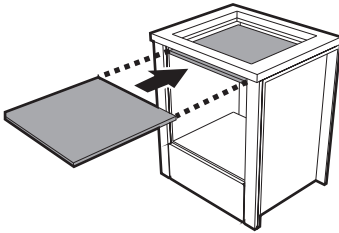

opens on bottom

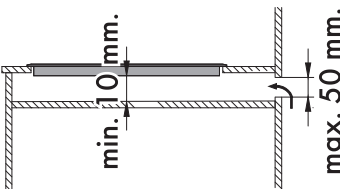

opens on rear



Failure to install the double-layer wooden base exposes the user to possible accidental contact with sharp or hot parts.

Hob seal

To prevent leakage of liquid between the frame of the hob and the work surface, place the adhesive seal provided along the entire outer edge of the hob before assembly.

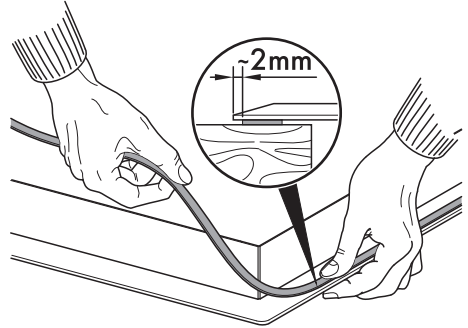

Do not use silicone to secure the hob. This would make it impossible to remove the hob, if necessary, without damaging it.

5.5 Fixing brackets

Screw the fixing brackets (**A**) into the holes on the sides of the bottom casing to properly fasten the hob to the structure.

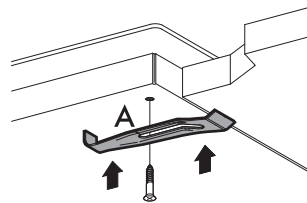



Installation

5.6 Gas connection



Gas leak
Danger of explosion

- After carrying out any operation, check that the tightening torque of gas connections is between 10 Nm and 15 Nm.
- If required, use a pressure regulator that complies with current regulations.
- At the end of the installation, check for any leaks with a soapy solution, never with a flame.
- The hoses should not come into contact with moving parts and should not be crushed in any way.

General informations

Connection to the gas mains can be made using a rigid copper pipe or a continuous wall steel hose in compliance with the provisions established by the applicable standard.

For supplying types of gas are shown in "Technical data table". Use approved gas tubing bearing EMSD approval marking (such as : 機電工程署批准 EMSD APPROVAL GTXXXX) for connection to appliances, or other appropriate methods accepted by EMSD.

According to the Gas Safety Ordinance of Hong Kong, any gas installation works including installation of appliances and connection tubing, must be undertaken by registered gas installers who are registered for that appropriate classes and be employed by registered gas contractor.



After installation, please make sure that the hoses do not come into contact with moving parts such as drawers.

Connection with a steel hose with conical fitting

Make the connection to the gas mains using a continuous wall steel hose whose specifications comply with the applicable standard.

Carefully screw the conical hose connector **3** to the appliance's gas connector **1** (1/2" thread ISO 228-1), placing the supplied seal **2** between them. Apply insulating material to the thread of connector **3**, then tighten the steel hose **4** to the connector **3**.

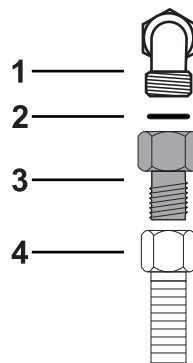



Room ventilation

The room where the appliance is installed must have enough air flow for the regular combustion of gas and the necessary air change in the room itself. The room must be kept adequately ventilated in order to eliminate the heat and humidity produced by cooking: In particular, after prolonged use, you are recommended to open a window or to increase the speed of any fans.

Lubricating the gas taps

Over time the gas taps may become difficult to turn and get blocked. Clean them internally and replace the lubrication grease.



Lubrication of the gas cocks should be performed by a specialised technician.

Technical data table

Product description	1-burner town gas hob			
Model	PC31GNOHK			
Top plate material	Glass ceramic			
Net weight	8.4kg			
Product dimensions	H x W x D: 102 x 300 x 510mm			
Gas type	Hong Kong Town Gas			
External gas governor	MAXITROL RV47LM-Rp1/2" (100mbar)			
Voltage and frequency	220-240V, 50/60Hz			
Electrical nominal power	1W			
Burner	Rated Heat Input (kW)	Nozzle Diameter (1/100 mm)	Reduced Heat Input (W)	Primary air (mm)
Ultra-rapid burner (UR) (Central)	5.3	430	2300	3.5



Installation

5.7 Electrical connection



**Power voltage
Danger of electrocution**

- Have the electrical connection performed by authorised technicians.
- Use personal protective equipment.
- The appliance must be connected to ground in compliance with electrical system safety standards.
- Disconnect the mains power supply.
- Do not pull the cable to remove the plug.
- Use cables withstanding a temperature of at least 90 °C.
- The tightening torque of the screws of the terminal board leads must be 1.5 - 2 Nm.

General information

Check the mains characteristics against the data indicated on the plate.

The identification plate bearing the technical data, serial number and brand name is visibly positioned on the appliance.

Do not remove this plate for any reason.

Perform the ground connection using a wire that is 20 mm longer than the other wires.



Pass the power supply cable through the back of the unit, taking care that it does not touch the bottom casing of the hob or the oven (if any) installed underneath it.

The appliance can work in the following modes:

- **220-240 V 1N~**

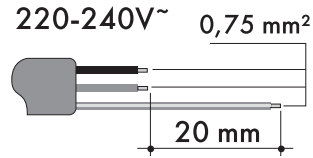

Use a **3 x 0.75 mm² three-core** cable.



The values indicated above refer to the cross-section of the internal lead.

Fixed connection

If a fixed connection is being used, fit the power line with an omnipolar circuit breaker with a contact opening gap equal to or greater than 3 mm, in an easily accessible position close to the appliance. The circuit breaker should be located near the appliance and in an easily reachable position.

Connection with plug and socket

Make sure that the plug and socket are of the same type.

Avoid using adapters and shunts as these could cause overheating and a risk of burns.

Testing

At the end of installation, carry out a brief inspection test. If the hob fails to operate, after checking that you have carried out the instructions correctly, unplug the appliance and contact Technical Support.



5.8 Instructions for the installer

- The plug must be accessible after installation. Do not bend or trap the power cable.
- The appliance must be installed according to the installation diagrams.
- Do not try to unscrew or force the threaded elbow of the fitting. You may damage this part of the appliance, which may void the manufacturer's warranty.
- Use soap and water to check for gas leaks on all connections. **DO NOT** use naked flames to find leaks.
- Turn on all the burners separately and at then all together to make sure that the gas valve, burner and ignition are working properly.
- Turn the burner knobs to the minimum position and check that the flame is stable for each individual burner and all the burners together.
- If the appliance does not work correctly after having carried out all the checks, contact your local Authorised Service Centre.
- Once the appliance has been installed, please explain to the user how to use it correctly.

