

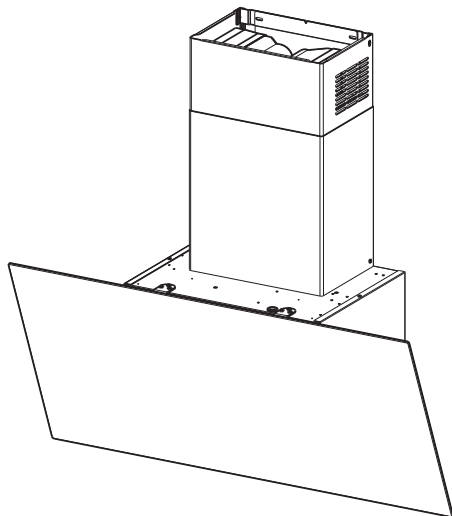

- EN COOKER HOOD
- DE DUNSTABZUGSHAUBE
- FR HOTTE DE CUISINE
- NL AFZUIGKAP
- ES CAMPANA
- PT EXAUSTOR
- IT CAPP
- SV SPISFLÄKT
- NO KJØKKENVIFTE
- FI LIESITUULETIN
- DA EMHÆTTE
- RU ВЫТЯЖКА
- PL OKAP KUCHENNY
- AR مدخنة



KICV60BL
KICV90BL
KICV90BL2

EN	USER MANUAL	3
DE	GEBRAUCHSANLEITUNG.....	8
FR	MANUEL D'UTILISATION.....	13
NL	GEBRUIKSAANWIJZING	18
ES	MANUAL DE USO	23
PT	LIVRO DE INSTRUÇÕES PARA UTILIZAÇÃO	28
IT	LIBRETTO DI USO	33
SV	ANVÄNDNINGSHANDBOK.....	38
NO	BRUKSVEILEDNING	43
FI	KÄYTTÖOHJEET.....	48
DA	BRUGSVEJLEDNING.....	53
RU	РУКОВОДСТВО ПО ЭКСПЛУАТАЦИИ	58
PL	INSTRUKCJA UŻYTKOWANIA.....	64
AR	كتيب الاستعمال 69

EN Recommendations and suggestions

- The Instructions for Use apply to several versions of this appliance. Accordingly, you may find descriptions of individual features that do not apply to your specific appliance.
- The manufacturer will not be held liable for any damages resulting from incorrect or improper installation.
- The minimum safety distance between the cooker top and the extractor hood is 650 mm (some models can be installed at a lower height, please refer to the paragraphs on working dimensions and installation).
- Check that the mains voltage corresponds to that indicated on the rating plate fixed to the inside of the hood.
- For Class I appliances, check that the domestic power supply guarantees adequate earthing. Connect the extractor to the exhaust flue through a pipe of minimum diameter 120 mm. The route of the flue must be as short as possible.
- Do not connect the extractor hood to exhaust ducts carrying combustion fumes (boilers, fireplaces, etc.).
- If the extractor is used in conjunction with non-electrical appliances (e.g. gas burning appliances), a sufficient degree of aeration must be guaranteed in the room in order to prevent the backflow of exhaust gas. The kitchen must have an opening communicating directly with the open air in order to guarantee the entry of clean air. When

the cooker hood is used in conjunction with appliances supplied with energy other than electric, the negative pressure in the room must not exceed 0,04 mbar to prevent fumes being drawn back into the room by the cooker hood.

- In the event of damage to the power cable, it must be replaced by the manufacturer or by the technical service department, in order to prevent any risks.
 - If the instructions for installation for the gas hob specify a greater distance specified above, this has to be taken into account. Regulations concerning the discharge of air have to be fulfilled.
 - Use only screws and small parts in support of the hood.
- Warning:** Failure to install the screws or fixing device in accordance with these instructions may result in electrical hazards.
- Connect the hood to the mains through a two-pole switch having a contact gap of at least 3 mm.

Use

- The extractor hood has been designed exclusively for domestic use to eliminate kitchen smells.
- Never use the hood for purposes other than for which it has been designed.
- Never leave high naked flames under the hood when it is in operation.
- Adjust the flame intensity to direct it onto the bottom of the pan only, making sure that it does not engulf the sides.
- Deep fat fryers must be continu-

ously monitored during use: overheated oil can burst into flames.

- Do not flambè under the range hood; risk of fire.
- This appliance can be used by children aged from 8 years and above and persons with reduced physical, sensory or mental capabilities or lack of experience and knowledge if they have been given supervision or instruction concerning use of the appliance in a safe way and understand the hazards involved. Children shall not play with the appliance. Cleaning and user maintenance shall not be made by children without supervision.
- This appliance is not intended for use by persons (including children) with reduced physical, sensory or mental capabilities, or lack of experience and knowledge, unless they have been given supervision or instruction concerning use of the appliance by a person responsible for their safety.
- **“CAUTION:** Accessible parts may become hot when used with cooking appliances.”

Maintenance

- The symbol  on the product or on its packaging indicates that this product may not be treated as household waste. Instead it shall be handed over to the applicable collection point for the recycling of electrical and electronic equipment. By ensuring this product is disposed of correctly, you will help prevent potential negative consequences for the environment and human health, which could other-

wise be caused by inappropriate waste handling of this product. For more detailed information about recycling of this product, please contact your local city office, your household waste disposal service or the shop where you purchased the product.

- Switch off or unplug the appliance from the mains supply before carrying out any maintenance work.
- Clean and/or replace the Filters after the specified time period (Fire hazard).
- “Failure to carry out cleaning as indicated will result in a fire hazard”.
 - The Activated charcoal filter is not washable and cannot be re-generated, and must be replaced approximately every 4 months of operation, or more frequently for particularly heavy usage **(W)**.

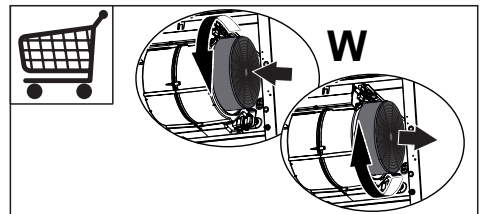

- The Grease filters must be cleaned every 2 months of operation, or more frequently for particularly heavy usage, and can be washed in a dishwasher **(Z)**.

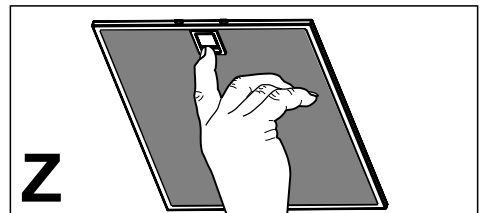

- Clean the hood using a damp cloth and a neutral liquid detergent.

Controls



Button	Function	Led
A	Turns the Motor off.	The Leds indicating the Speed of the motor turn off.
B	Activates speed one.	The Leds indicating Speed one and Motor Off turn on.
C	Activates speed two.	The Leds indicating Speed two and Motor Off turn on.
D	Activates speed three.	The Leds indicating Speed three and Motor Off turn on.
E	Activates Intensive speed. This speed is timed to run for 6 minutes. At the end of this time the system will automatically return to the speed set before. It is disabled by pressing the Button or turning the Motor off.	Flashes once a second.
F	Starts the 24H function, in which the motor starts at a speed that allows suction of 100 m ³ /h for 10 minutes per hour. This mode cannot be activated if Intensive or Delay modes are active. To turn it off press the button again.	The Leds indicating F speed and Motor Off turn on.
	When the filters alarm is triggered, the alarm can be reset by pressing and holding this button for approximately 5 seconds. Led A flashes three times. These indications are only visible when the motor is turned off.	When the procedure terminates, the indication shown previously turns off: F Flashing Indicates the need to change the activated charcoal filters, and also to wash the metal grease filters. The alarm is triggered after the Hood has been in operation for 100 working hours.
G	Activates Delay mode, causing automatic shutdown of the Motor and the Lighting system with a 30' delay. It is disabled by pressing the button or turning the motor off. This mode does not function if Intensive or 24h is active.	Led G turns on, and the button for the selected speed flashes every 0.5"
H	Turns the lighting system on and off at maximum intensity.	The Lighting Led lights up.

On start-up the board recognises the mains frequency.

Recognition is indicated on the display:

- 50Hz: LED A flashes once
- 60Hz : LED A flashes twice

Lighting

- For replacement contact technical support (“To purchase contact technical support”).

Auto-Vent

It is an advanced automatic function which connects the hob to a special hood. Both the hob and the hood have an infrared signal communicator. Speed of the fan is defined automatically on basis of mode setting and temperature of the hottest cookware on the hob. You can also operate the fan from the hob manually.

Operating the function automatically

To operate the function automatically set the automatic mode to H1 – H6. The hob is originally set to H5. The hood reacts whenever you operate the hob. The hob recognizes temperature of the cookware automatically and adjusts the speed of the fan.

Automatic modes





	Auto- matic light	Boil- ing ¹⁾	Fry- ing ²⁾
Mode H0	Off	Off	Off
Mode H1	On	Off	Off
Mode H2 ³⁾	On	Fan speed 1	Fan speed 1
Mode H3	On	Off	Fan speed 1
Mode H4	On	Fan speed 1	Fan speed 1
Mode H5	On	Fan speed 1	Fan speed 2
Mode H6	On	Fan speed 2	Fan speed 3

1) The hob detects the boiling process and activates fan speed in accordance with automatic mode.

2) The hob detects the frying process and activates fan speed in accordance with automatic mode.





3) This mode activates the fan and the light and does not rely on the temperature.

Changing the automatic mode

1. Deactivate the appliance.
2. Touch  for 3 seconds. The display comes on and goes off.
3. Touch  for 3 seconds.
4. Touch **TIMER** a few times until  comes on.
5. Touch  of the Timer to select an automatic mode.

- i** When you finish cooking and deactivate the hob, the hood fan may still operate for a certain period of time. After that time the system deactivates the fan automatically and prevents you from accidental activation of the fan for the next 30 seconds.

Operating the fan speed manually

You can also operate the function manually. To do that touch  when the hob is active. This deactivates automatic operation of the function and allows you to change the fan speed manually. When you press  you raise the fan speed by one. When you reach an intensive level and press  again you will set fan speed to 0 which deactivates the hood fan. To start the fan again with fan speed 1 touch .

- i** To activate automatic operation of the function, deactivate the hob and activate it again.

Activating the light

You can set the hob to activate the light automatically whenever you activate the hob. To do so set the automatic mode to H1 – H6.

- i** The light on the hood deactivates 2 minutes after deactivating the hob.