

Contents

1	Instructions	36
1.1	General safety instructions	36
1.2	Appliance purpose	39
1.3	Manufacturer's liability	39
1.4	This user manual	40
1.5	Identification plate	40
1.6	Disposal	40
1.7	How to read the user manual	41
2	Description	42
2.1	General Description	42
2.2	Control panel	43
2.3	Other parts	44
2.4	Available accessories	44
3	Use	46
3.1	Instructions	46
3.2	First use	46
3.3	Using the accessories	47
3.4	Using the oven	48
3.5	Programmer clock	49
3.6	Cooking advice	53
4	Cleaning and maintenance	57
4.1	Instructions	57
4.2	Cleaning the surfaces	57
4.3	Ordinary daily cleaning	57
4.4	Food stains or residues	57
4.5	Removing the door	57
4.6	Cleaning the door glazing	58
4.7	Removing the internal glass panes	58
4.8	Cleaning the inside of the oven	59
4.9	Extraordinary maintenance	61
5	Installation	62
5.1	Electrical connection	62
5.2	Cable replacement	63
5.3	Positioning	63
5.4	Instructions for the installer	66

We advise you to read this manual carefully, which contains all the instructions for maintaining the appliance's aesthetic and functional qualities.

For further information on the product: www.smeg.com



Instructions

1 Instructions

1.1 General safety instructions

Risk of personal injury

- During use the appliance and its accessible parts become very hot. Never touch the heating elements during use.
- Protect your hands by wearing oven gloves when moving food inside the oven.
- Never try to put out a fire or flames with water: Turn off the appliance and smother the flames with a fire blanket or other appropriate cover.
- This appliance may be used by children aged at least 8 and by people of reduced physical, sensory or mental capacity, or lacking in experience in the use of electrical appliances, provided that they are supervised or instructed by adults who are responsible for their safety.
- Children must not play with the appliance.
- Keep children under the age of eight at a safe distance unless they are constantly supervised.
- Keep children under the age of 8 away from the appliance when it is in use.
- Cleaning and maintenance must not be carried out by unsupervised children.
- Do not cook dishes containing large quantities of strong alcoholic beverages. Alcohol vapours in the oven could catch fire.
- The cooking process must always be monitored. A short cooking process must be continuously monitored.
- Never leave the appliance unattended during cooking operations where fats or oils could be released, as these could then heat up and catch fire. Be very careful.
- Do not pour water directly onto very hot trays.
- Keep the oven door closed during cooking.
- If you need to move food or at the end of cooking, open the door 5 cm for a few seconds, let the steam come out, then open it fully.
- Do not insert pointed metal objects (cutlery or utensils) into the slots in the appliance.



- Switch off the appliance immediately after use.
- **DO NOT USE OR STORE FLAMMABLE MATERIALS NEAR THE APPLIANCE.**
- **DO NOT USE AEROSOLS IN THE VICINITY OF THIS APPLIANCE WHILST IT IS IN USE.**
- **DO NOT MODIFY THIS APPLIANCE.**
- Installation and servicing should be carried out by qualified personnel in accordance with current standards.
- Do not try to repair the appliance yourself or without the assistance of a qualified technician.
- Do not pull the cable to unplug the appliance.
- Do not sit on the appliance.
- Do not use cleaning products containing chlorine, ammonia or bleach on parts made of steel or that have metallic surface finishes (e.g. anodizing, nickel- or chromium-plating).
- Racks and trays should be inserted as far as they will go into the side guides. The mechanical safety locks that prevent them from being removed must face downwards and towards the back of the oven cavity.
- Do not use steam jets to clean the appliance.
- Do not spray any spray products near the appliance.
- Do not obstruct ventilation openings and heat dispersal slots.
- Never leave objects on the cooking surface.
- **DO NOT FOR ANY REASON USE THE APPLIANCE AS A SPACE HEATER.**
- Do not use plastic cookware or containers when cooking food.
- Do not put sealed tins or containers in the oven.

Risk of damaging the appliance

- Do not use abrasive or corrosive detergents (e.g. scouring powders, stain removers and metallic sponges) on glass parts. Use wooden or plastic utensils.
- Do not use rough or abrasive materials or sharp metal scrapers.



Instructions

- Remove all trays and racks which are not required during cooking.
- Do not cover the bottom of the oven cavity with aluminium or tin foil sheets.
- Do not place pans or trays directly on the bottom of the oven cavity.
- If you wish to use greaseproof paper, place it so that it will not interfere with the hot air circulation inside the oven.
- Do not use the open door to rest pans or trays on the internal glass pane.
- Never use the oven door to lever the appliance into place when fitting.
- Avoid exerting too much pressure on the oven door when open.
- Do not use the handle to lift or move the appliance.

Installation and maintenance

- THIS APPLIANCE **MUST NOT BE INSTALLED** IN BOATS OR CARAVANS.
- The appliance must not be installed on a pedestal.
- Position the appliance into the cabinet cut-out with the help of a second person.
- To avoid potential overheating, the appliance must not be installed behind a decorative door or a panel.
- Installation and servicing should be carried out by qualified personnel in accordance with current standards.
- Have the electrical connection performed by authorised technical personnel.
- The appliance must be connected to earth in compliance with electrical system safety standards.
- Use cables withstanding a temperature of at least 90 °C.
- The tightening torque of the screws of the terminal supply wires must be 1.5 - 2 Nm.



- If the power supply cable is damaged, contact technical support immediately and they will replace it.
- Always use any necessary/required personal protective equipment (PPE) before performing any work on the appliance (installation, maintenance, positioning or movement).
- Before performing any work on the appliance, switch off the power supply.
- This appliance can be used up to a maximum altitude of 4,000 metres above sea level.
- Ensure that the appliance is switched off before replacing the bulb.
- Do not place food and/or any other object directly on the bottom of the oven cavity.
- Do not rest any weight or sit on the open door of the appliance.
- Take care that no objects are stuck in the doors.
- Do not install / use the appliance outdoors.

For this appliance

- Take care because steam may not be visible at certain temperatures.
 - The maximum capacity of the evaporation tray is 250 ml.
 - Be very careful not to exceed the maximum capacity of the evaporation tray.
 - Open the appliance door carefully during or after cooking.
 - Dishes must be heat and steam resistant.
- ### 1.2 Appliance purpose
- This appliance is intended for cooking food in the home environment. Every other use is considered improper.
 - The appliance is not designed to operate with external timers or with remote-control systems.
- ### 1.3 Manufacturer's liability
- The manufacturer declines all liability for damage to persons or property caused by:
- Use of the appliance other than that specified
 - Failure to comply with the instructions in the user manual
 - Tampering with any part of the appliance
 - The use of non-original spare parts.



Instructions

1.4 This user manual

This user manual is an integral part of the appliance and must therefore be kept in its entirety and within the user's reach for the whole working life of the appliance.

Read this user manual carefully before using the appliance.

1.5 Identification plate

The identification plate bears the technical data, serial number and brand name of the appliance. Do not remove the identification plate for any reason.

1.6 Disposal



This appliance must be disposed of separately from other waste (Directives 2002/95/EC, 2002/96/EC, 2003/108/EC). The appliance does not contain substances in quantities sufficient to be considered hazardous to health and the environment, in accordance with current European directives.

To dispose of the appliance:

- Cut the power supply cable and remove it along with the plug.



Power voltage

Danger of electrocution

- Disconnect the mains power supply.
- Unplug the appliance.



- Deliver the appliance to the appropriate recycling centre for electrical and electronic equipment waste, or return it to the retailer when purchasing an equivalent product, on a one for one basis.

Our appliances are packaged in non-polluting and recyclable materials.

- Deliver the packing materials to the appropriate recycling centre.



Plastic packaging Danger of suffocation

- Do not leave the packaging or any part of it unattended.
- Do not let children play with the plastic bags.

1.7 How to read the user manual

This user manual uses the following reading conventions:

Instructions



General information on this user manual, on safety and final disposal.

Description



Description of the appliance and its accessories.

Use



Information on the use of the appliance and its accessories, cooking advice.

Cleaning and maintenance



Information for proper cleaning and maintenance of the appliance.

Installation



Information for the qualified technician: Installation, operation and inspection.



Safety instructions



Information



Advice

1. Sequence of instructions for use.
Standalone instruction.



2 Description

2.1 General Description

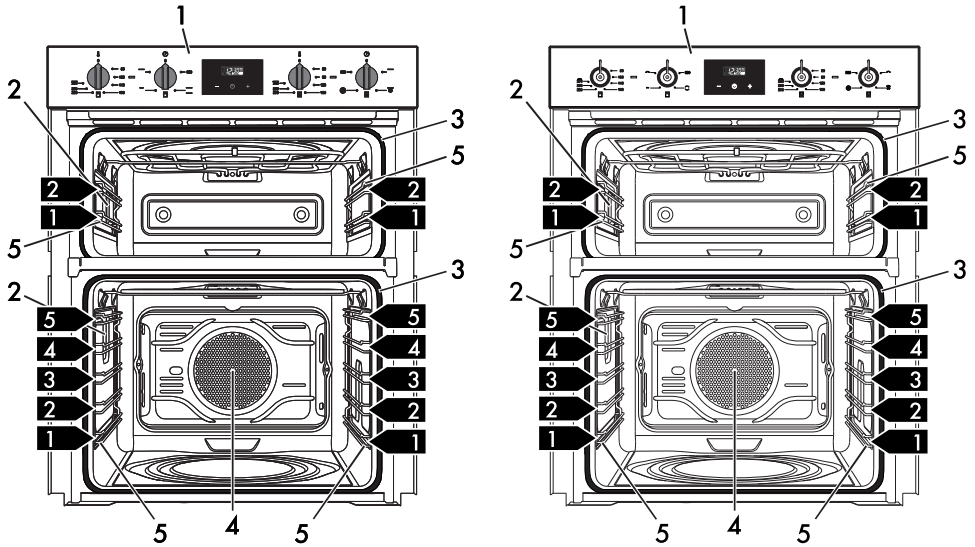

1 Control panel

2 Oven light

3 Seal

4 Fan

5 Rack/tray support frames

1,2,3... Frame shelf



2.2 Control panel

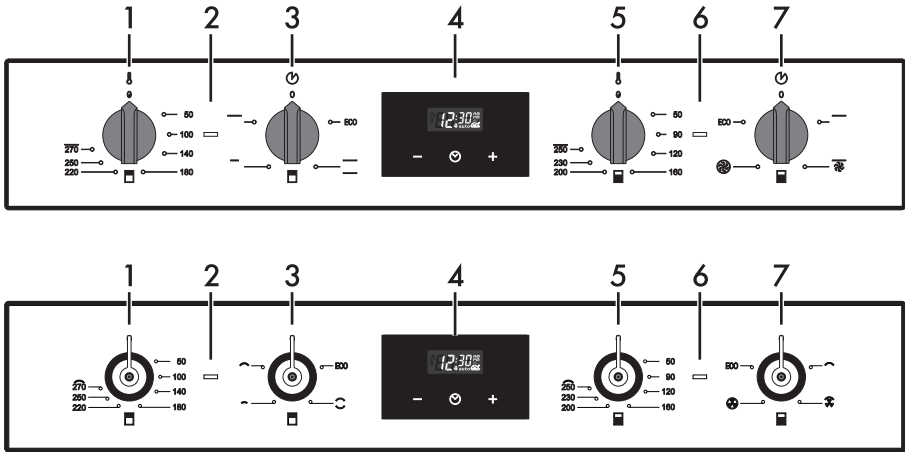

Auxiliary oven temperature knob (1)

This knob allows you to select the cooking temperature.

Turn the knob clockwise to the required value, between the minimum and maximum setting.

Auxiliary oven thermostat indicator light (2)

The thermostat indicator light remains lit when the oven is heating up. Once the oven has reached the selected temperature the indicator light switches off.

Auxiliary oven function knob (3)

The oven's various functions are suitable for different cooking modes. After selecting the required function, set the cooking temperature using the temperature knob.

Programmer clock (4)

Useful for displaying the current time, setting programmed cooking operations and programming the minute minder timer.

Main oven temperature knob (5)

This knob allows you to select the cooking temperature.

Turn the knob clockwise to the required value, between the minimum and maximum setting.

Main oven thermostat indicator light (6)

The thermostat indicator light remains lit when the oven is heating up. Once the oven has reached the selected temperature the indicator light switches off.

Main oven function knob (7)

The oven's various functions are suitable for different cooking modes. After selecting the required function, set the cooking temperature using the temperature knob.



Description

2.3 Other parts

Shelves

The appliance features shelves for positioning trays and racks at different heights. The insertion heights are indicated from the bottom upwards (see 2.1 General Description).

Cooling fan

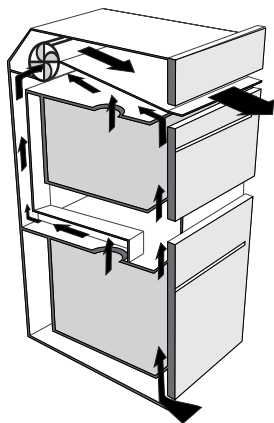

The fan cools the oven and comes into operation during cooking.

The fan causes a steady outflow of air from above the door which may continue for a brief period of time even after the appliance has been turned off.

Interior lighting

The oven light comes on when the door is opened or any function is selected.

2.4 Available accessories



Some models are not provided with all accessories.

Rack

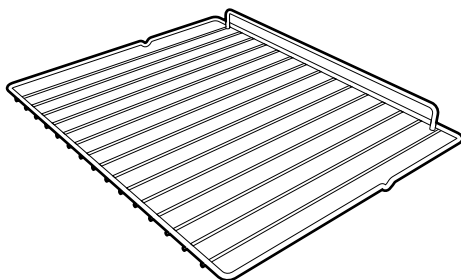

Useful for supporting containers with food during cooking.

Tray rack

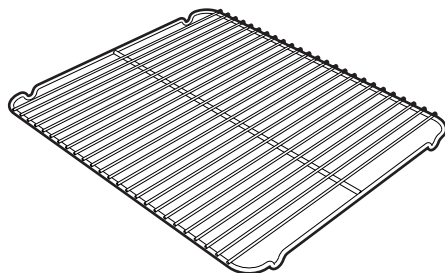

To be placed over the top of the oven tray; for cooking foods which may drip.



Deep tray

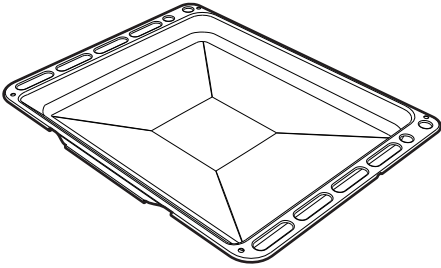

Useful for collecting fat from foods placed on the rack above and for cooking pies, pizzas and baked desserts.

i The oven accessories intended to come into contact with food are made of materials that comply with the provisions of current legislation.

i Original supplied and optional accessories can be requested to Authorised Assistance Centres. Use only original accessories supplied by the manufacturer.



3 Use

3.1 Instructions



High temperature inside the oven during use

Danger of burns

- Keep the oven door closed during cooking.
- Protect your hands wearing heat resistant gloves when moving food inside the oven.
- Do not touch the heating elements inside the oven.
- Do not pour water directly onto very hot trays.
- Do not allow children to get near the oven when it is in operation.



High temperature inside the oven during use

Danger of fire or explosion

- Do not spray any spray products near the oven.
- Do not use or leave flammable materials near the oven.
- Do not use plastic kitchenware or containers when cooking food.
- Do not put sealed tins or containers in the oven.
- Do not leave the oven unattended during cooking operations where fats or oils could be released.
- Remove all trays and racks which are not required during cooking.



Improper use

Risk of damage to enamelled surfaces

- Do not cover the bottom of the oven cavity with aluminium or tin foil sheets.
- If you wish to use greaseproof paper, place it so that it will not interfere with the hot air circulation inside the oven.
- Do not place pans or trays directly on the bottom of the oven cavity.
- Do not pour water directly onto very hot trays.

3.2 First use

1. Remove any protective film from the outside or inside of the appliance, including accessories.
2. Remove any labels (apart from the technical data plate) from the accessories and from the oven cavity.
3. Remove and wash all the appliance accessories (see 4 Cleaning and maintenance).
4. Heat the empty oven at the maximum temperature to burn off any residues left by the manufacturing process.



3.3 Using the accessories

Racks and trays

Racks and trays have to be inserted into the side guides until they come to a complete stop.

- The mechanical safety locks that prevent the rack from being taken out accidentally have to face downwards and towards the oven back.

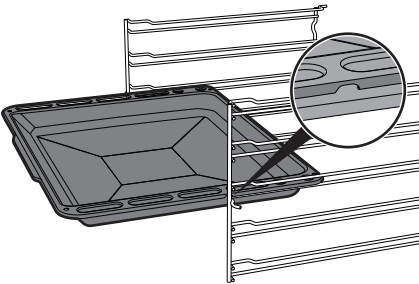
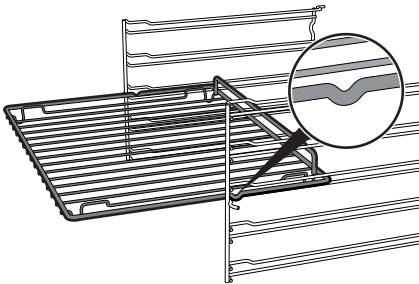

Gently insert racks and trays into the oven until they come to a stop.



Clean the trays before using them for the first time to remove any residues left by the manufacturing process.

Tray rack

The tray rack has to be inserted into the tray. In this way fat can be collected separately from the food which is being cooked.

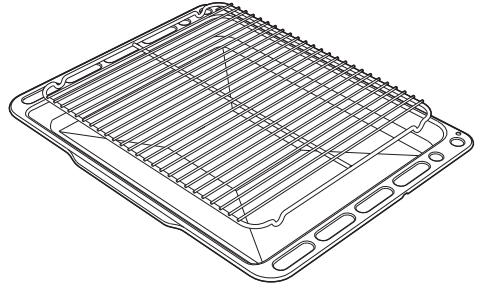



3.4 Using the oven

Switching the oven on

To switch the oven on:

1. Select the cooking function using the function knob.
2. Select the temperature using the temperature knob.

Functions list

ECO

Eco

This function is particularly suitable for cooking on a single shelf with low energy consumption. It is recommended for all types of food except those that may produce a large amount of moisture (e.g. vegetables).

To obtain maximum energy savings and reduce cooking times, it is recommended not to preheat the oven before placing food in it.



When using the ECO function, avoid opening the door during cooking.



Cooking (and preheating) times are longer with the ECO function and may depend on the amount of food in the oven cavity.



The ECO function is a delicate cooking function and is recommended for cooking that does not require temperatures higher than 210°C. It is recommended that you select a different function for cooking at higher temperatures.



Static

As the heat comes from above and below at the same time, this system is particularly suitable for certain types of food. Traditional cooking, also known as static cooking, is suitable for cooking just one dish at a time. Perfect for all types of roasts, bread and cakes and in any case particularly suitable for fatty meats such as goose and duck.



Fan with grill

The air produced by the fan softens the strong heatwave generated by the grill, grilling perfectly even very thick foods. Perfect for large cuts of meat (e.g. shin of pork).



Grill

The heat coming from the grill element gives perfect grilling results above all for thin and medium thickness meat and in combination with the rotisserie (where fitted) gives the food an even browning at the end of cooking. Perfect for sausages, spare ribs and bacon. This function enables large quantities of food, particularly meat, to be grilled evenly.



Small grill

Using only the heat released from the central element, this function allows you to grill small portions of meat and fish for making kebabs, toasted sandwiches and any types of grilled vegetable side dishes.





Fan + circulaire

The combination of the fan and the circulaire heating element (incorporated in the rear of the oven) allows you to cook different foods on several levels, as long as they need the same temperatures and same type of cooking. Hot air circulation ensures instant and even distribution of heat. It will be possible, for instance, to cook fish, vegetables and biscuits simultaneously (on different levels) without odours and flavours mingling.





3.5 Programmer clock



 Value decrease key

 Clock key

 Increase key

i Ensure that the programmer clock shows the cooking duration symbol , otherwise it will not be possible to turn on the oven. Press the key  to reset the programmer clock.







Use

Setting the time





If the time is not set, the oven will not switch on.

On the first use, or after a power failure, the digits  will be flashing on the appliance's display.

1. Hold down the clock key  for two seconds. The dot between the hours and the minutes flashes.
2. The time can be set via the value increase key  and value decrease key . Keep the key pressed in to increase or decrease rapidly.
3. Wait 7 seconds. The dot between the hours and the minutes stops flashing.
4. The symbol  on the display indicates that the appliance is ready to start cooking.













To change the time, hold down the value increase key  and value decrease key  at the same time for two seconds, then set the time.

Timed cooking (only for the main oven)







Timed cooking is the function which allows a cooking operation to be started and then ended after a specific length of time set by the user.

1. Keep the clock key  pressed until the symbol  appears.
 2. Press the clock key  again. On the display the symbol  and the text  appear, alternating with the current time.
 3. Use the value increase  and value decrease  keys to set the required minutes of cooking.
 4. Select a function and a cooking temperature.
 5. Wait approx. 5 seconds without pressing any key in order for the function to activate. The current time and the symbols  and  will appear on the display.
- At the end of cooking the heating elements will be deactivated. On the display, the symbol  turns off, the symbol  flashes and the buzzer sounds.
6. To turn the buzzer off, simply press one of the programmer clock keys.









7. Press the clock key  to reset the programmer clock.







 It is not possible to set a cooking time of more than 10 hours.

 To cancel the set programming press and hold down the value increase  and the value decrease  keys at the same time and then turn the oven off manually.





Programmed cooking (only for the main oven)

 Programmed cooking is the function which allows a cooking operation to be started at a set time and then ended after a specific length of time set by the user.

1. Set the cooking time as described in the previous point "Timed cooking (only for the main oven)".
2. Hold the menu key  down for 2 seconds.
3. Press the menu key  again. The display will show the digits  and the text  in sequence, while the  symbol flashes (for example, the current time is 17:30)



4. Use the  or  key to set the required minutes. (for example 1 hour)
5. Press the menu key . The text  will appear on the display in sequence with the pre-set cooking duration added to the current time (for example, the cooking end time shown is 18:30).
6. Press the  or  key to set the cooking end time. (for example, 19:30).

 Bear in mind that a few minutes for oven preheating must be added to the cooking time.

7. Wait approx. 7 seconds without pressing any key in order for the function to activate. The current time and the  and  symbols appear on the display.
8. Select a cooking temperature and function.
9. At the end of cooking the heating elements will be deactivated. On the display, the symbol  turns off, the symbol  flashes and the buzzer sounds.



Use

10. Return the function and temperature knobs to **0**.
11. To turn off the buzzer just press any key of the programmer clock.
12. Press the  and  keys at the same time to reset the set program.





It is not possible to set a cooking time of more than 10 hours.



It is not possible to set a programmed cooking time of more than 24 hours.











After setting, hold the menu key  down for 2 seconds to display the cooking time remaining. Press the menu key  again. The display shows the text  and the remaining cooking time in sequence.

Minute minder timer



The minute minder timer does not stop the cooking operation but rather informs the user when the set time has run out.

The minute minder timer can be activated at any time.



1. Keep the clock key  pressed for per a few seconds. The display shows the figures  and the symbol  flashing between the hours and minutes.
 2. Use the value increase  and value decrease  keys to set the number of minutes required.
 3. Wait approx. 5 seconds without pressing any key to finish setting the minute minder. The current time and the symbols  and  appear on the display.
- A buzzer will sound when the set time is reached.
4. Press the value decrease key  to turn the buzzer off.





The minute minder timer can be set from 1 minute to a maximum of 23 hours and 59 minutes.



Modifying the set data





1. Press the clock key .
2. Use the value increase  and value decrease  keys to set the number of minutes required.

Deleting the set data

1. Press the clock key .
2. Hold down the value increase  and value decrease  keys at the same time.
3. Then switch off the oven manually if cooking is in progress.

Selecting the buzzer

The buzzer can have 3 tones.

1. Hold down the value increase  and value decrease  keys at the same time.
2. Press the clock key .
3. Press the value decrease key  to select a different buzzer tone

3.6 Cooking advice

General advice

- Use a fan assisted function to achieve consistent cooking at several levels.
- It is not possible to shorten cooking times by increasing the temperature (the food could be overcooked on the outside and undercooked on the inside).

Advice for cooking meat

- Cooking times vary according to the thickness and quality of the food and to consumer taste.
- Use a meat thermometer when roasting meat, or simply press on the roast with a spoon. If it is hard, it is ready; if not, it needs another few minutes cooking.

Advice for cooking with the Grill and the Fan with grill

- Meat can be grilled even when it is put into the cold oven or into the preheated oven if you wish to change the effect of the cooking.
- With the Fan with grill function, we recommend that you preheat the oven before grilling.
- We recommend placing the food at the centre of the rack.
- With the Grill function, we recommend that you turn the temperature knob to the maximum value near the  symbol to optimise cooking.



Advice for cooking desserts/pastries and biscuits

- Use dark metal moulds: they help to absorb the heat better.
- The temperature and the cooking time depend on the quality and consistency of the dough.
- To check whether the dessert is cooked right through: at the end of the cooking time, put a toothpick into the highest point of the dessert. If the dough does not stick to the toothpick, the dessert is cooked.
- If the dessert collapses when it comes out of the oven, on the next occasion reduce the set temperature by about 10°C, selecting a longer cooking time if necessary.

Advice for defrosting and proving

- Place frozen foods without their packaging in a lidless container on the first shelf of the oven.
- Avoid overlapping the food.
- To defrost meat, use the rack placed on the second level and a tray on the first level. In this way, the liquid from the defrosting food drains away from the food.
- The most delicate parts can be covered with aluminium foil.
- For successful proving, a container of water should be placed in the bottom of the oven.

To save energy

- Stop cooking a few minutes before the time normally used. Cooking will continue for the remaining minutes with the heat which has accumulated inside the oven.
- Reduce any opening of the door to a minimum to avoid heat dispersal.
- Keep the inside of the appliance clean at all times.



Main oven cooking information table

Food	Weight (Kg)	Function	Runner position from the bottom	Temperature (°C)	Time (minutes)	
Lasagne	3 - 4	Fan + circulaire	1	210 - 220	45 - 50	
Pasta bake	3 - 4	Fan + circulaire	1	210 - 220	45 - 50	
Roast veal	2	Fan + circulaire	2	180 - 190	90 - 100	
Pork	2	Fan + circulaire	2	180 - 190	70 - 80	
Roast beef	1	Fan + circulaire	2	200	40 - 45	
Roast rabbit	1.5	Fan + circulaire	2	180 - 190	70 - 80	
Turkey breast	3	Fan + circulaire	2	180 - 190	110 - 120	
Roast pork neck	2 - 3	Fan + circulaire	2	180 - 190	170 - 180	
Roast chicken	1.2	Fan + circulaire	2	180 - 190	65 - 70	
					1st surface	2nd surface
Pork chops	1.5	Fan with grill	4	250	16	6
Spare ribs	1.5	Fan with grill	4	250	12	12
Sausages	1.5	Fan with grill	4	250	12	7
Bacon	0.7	Grill	5	250	7	8
Pork fillet	1.5	Fan with grill	4	250	10	5
Beef fillet	1	Grill	5	250	10	7
Salmon trout	1.2	Fan + circulaire	2	160 - 170	35 - 40	
Monkfish	1.5	Fan + circulaire	2	160 - 170	60 - 65	
Turbot	1.5	Fan + circulaire	2	160 - 170	45 - 50	
Pizza	1	Fan + circulaire	2	200 - 220	12 - 17	
Bread	1	Fan + circulaire	2	180 - 200	25 - 35	
Focaccia	1	Fan + circulaire	2	180 - 190	20 - 30	
Sponge cake	1	Fan + circulaire	2	160	55 - 60	
Jam tart	1	Fan + circulaire	2	160	35 - 40	
Ricotta cake	1	Fan + circulaire	2	160 - 170	55 - 60	
Jam tarts	1	Fan + circulaire	2	160	20 - 25	
Paradise cake	1.2	Fan + circulaire	2	160	55 - 60	
Cream puffs	1.2	Fan + circulaire	2	180	80 - 90	
Light sponge cake	1	Fan + circulaire	2	150 - 160	55 - 60	
Rice pudding	1	Fan + circulaire	2	160	55 - 60	
Brioches	0.6	Fan + circulaire	2	160	30 - 35	

The times indicated in the table do not include preheating times and are provided as a guide only.



Use

Auxiliary oven cooking information table

Food	Weight (Kg)	Function	Runner position from the bottom	Temperature (°C)	Time (minutes)	
Lasagne	3 / 4	Static	1 or 2	220 - 230	50 - 60	
Pasta bake	2	Static	1 or 2	220 - 230	40	
Roast veal	1	Static	2	180 - 190	70 - 80	
Pork loin	1	Static	2	180 - 190	70 - 80	
Pork shoulder	1	Static	2	180 - 190	90 - 100	
Roast rabbit	1	Static	2	180 - 190	70 - 80	
Turkey breast	1.5	Static	2	180 - 190	89 - 90	
Roast chicken	1	Static	2	190 - 200	55 - 60	
					1st surface	2nd surface
Pork chops	1	Grill	2	250 - 280	7 - 9	5 - 7
Pork fillet	1	Grill	2	250 - 280	9 - 11	5 - 9
Sausages	1	Grill	2	250 - 270	7 - 9	5 - 6
Bacon	0.8	Grill	1/2	270	6 - 7	3 - 4
Salmon trout	1	Static	1	250 - 270	14 - 16	
Pizza	1	Static	1	280	8	
Focaccia	0.8	Static	2	180 - 190	15 - 20	
Tart		Static	1	170 - 180	35 - 40	
Short pastry		Static	1	170 - 180	20 - 25	
Rice pudding	1	Static	1	170 - 180	50 - 60	
Apple pie	0.5	Static	2	180	60	

The times indicated in the table do not include preheating times and are provided as a guide only.



4 Cleaning and maintenance

4.1 Instructions



Improper use
Risk of damage to surfaces

- Do not use steam jets for cleaning the appliance.
- Do not use cleaning products containing chlorine, ammonia or bleach on steel parts or parts with metallic finishes on the surface (e.g. anodizing, nickel- or chromium-plating).
- Do not use abrasive or corrosive detergents on glass parts (e.g. powder products, stain removers and metallic sponges).
- Do not use rough or abrasive materials or sharp metal scrapers.

4.2 Cleaning the surfaces

To keep the surfaces in good condition, they should be cleaned regularly after use. Let them cool first.

4.3 Ordinary daily cleaning

Always use only specific products that do not contain abrasives or chlorine-based acids.

Pour the product onto a damp cloth and wipe the surface, rinse thoroughly and dry with a soft cloth or a microfibre cloth.

4.4 Food stains or residues

Do not use metallic sponges or sharp scrapers as they will damage the surfaces.

Use ordinary non-abrasive products with the aid of wooden or plastic utensils if necessary. Rinse thoroughly and dry with a soft cloth or a microfibre cloth.

Do not allow residues of sugary foods (such as jam) to set inside the oven. If left to set for too long, they might damage the enamel lining of the oven.

4.5 Removing the door

For easier cleaning, the door can be removed and placed on a canvas.

To remove the door proceed as follows:

1. Open the door completely and insert two pins into the holes on the hinges indicated in the figure.

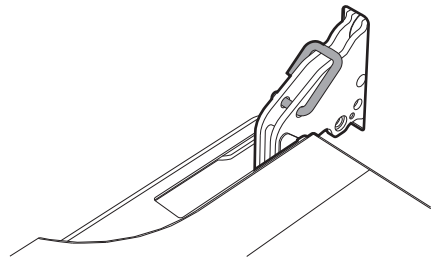



Cleaning and maintenance

2. Grasp the door on both sides with both hands, lift it forming an angle of around 30° and remove it.

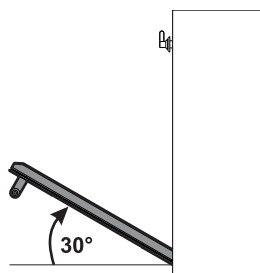

3. To reassemble the door, put the hinges in the relevant slots in the oven, making sure that grooved sections **A** are resting completely in the slots. Lower the door and once it is in place remove the pins from the holes in the hinges.

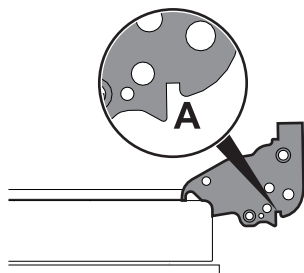

4.6 Cleaning the door glazing

The glass in the door should always be kept thoroughly clean. Use absorbent kitchen roll. In case of stubborn dirt, wash with a damp sponge and an ordinary detergent.



We recommend the use of cleaning products distributed by the manufacturer.

4.7 Removing the internal glass panes

For easier cleaning the door internal glass panes can be disassembled.

1. Remove the internal glass pane by pulling the rear part gently upwards, following the movement indicated by the arrows (1).
2. Then, pull the front part upwards (2). In this way, the 4 pins attached to the glass detach from their housings in the oven door.

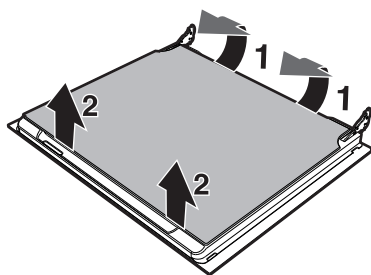

3. Some models have an intermediate glass pane. Remove the intermediate glass pane by lifting it upwards.

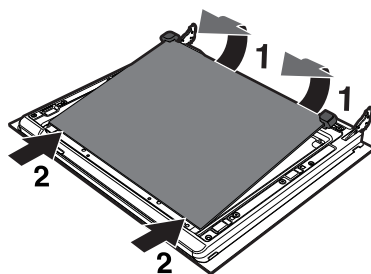



4. Clean the external glass pane and the panes previously removed. Use absorbent kitchen roll. In case of stubborn dirt, wash with a damp sponge and neutral detergent.

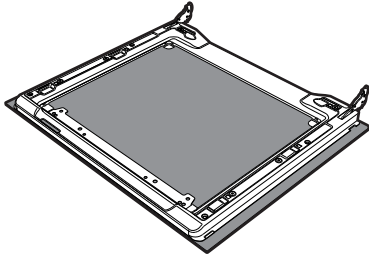

5. Refit the panes in the reverse order in which they were removed.
6. Reposition the internal glass pane. Take care to centre and insert the 4 pins into their housings in the oven door by applying slight pressure.

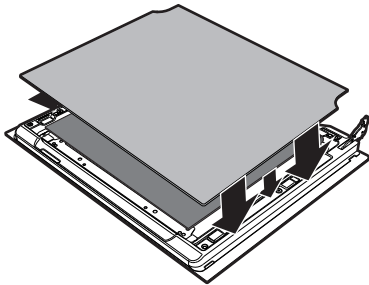

4.8 Cleaning the inside of the oven

For the best oven upkeep, clean it regularly after having allowed it to cool. Take out all removable parts.

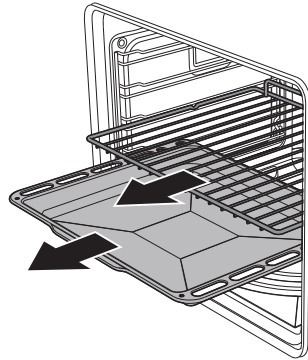
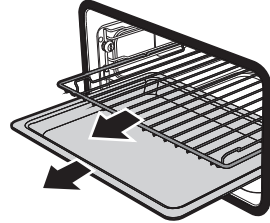

Clean the oven racks with warm water and non-abrasive detergent. Carefully rinse and dry damp parts.



The oven should be operated at the maximum temperature for about 15-20 minutes after the use of specific products, to burn off the residues left inside the oven.



For easier cleaning, remove the door.



Cleaning and maintenance

Removing racks/trays support frames

Removing the guide frames enables the sides to be cleaned more easily. This operation should be performed each time the automatic cleaning cycle is used (on some models only).

To remove the guide frames: Pull the frame towards the inside of the oven to unhook it from its groove **A**, then slide it out of the seats **B** at the back.

When cleaning is complete, repeat the above procedures to put the guide frames back in.

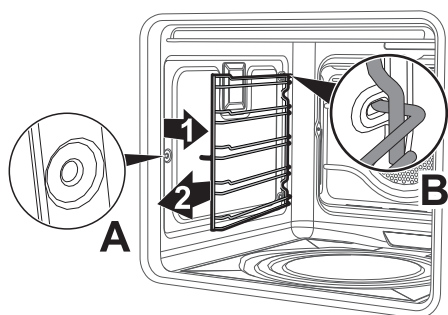

Cleaning the upper part (auxiliary oven)



High temperature inside the oven during use

Danger of burns

- The following operations must be carried out only with the oven completely cold and turned off.

The appliance is equipped with a tilting grill element that allows for easy cleaning of the upper part of the oven cavity.

1. Free the upper heating element by gently lifting it and rotating its retaining latch by 90 degrees.

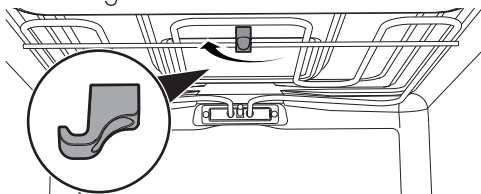

2. Gently lower the heating element until it stops.

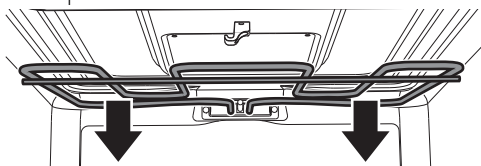

Improper use

Risk of damage to the appliance

- Do not excessively flex the element during cleaning.

When you have finished cleaning, place the heating element back in position and turn the retaining latch to lock it in place.



4.9 Extraordinary maintenance



Live parts
Danger of electrocution

- Disconnect the oven power supply.

Replacing the internal light bulb

1. Completely remove all accessories from inside the oven.
2. Remove the racks/trays support frames.
3. Remove the bulb cover using a tool (e.g. a screwdriver).

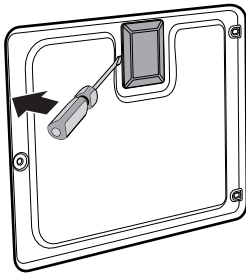

4. Slide out and remove the lamp.

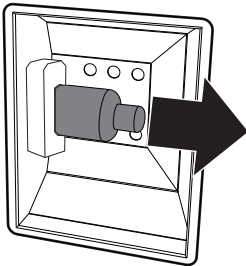

- Do not touch the halogen lamp directly with your fingers, but wrap it in insulating material.
- Pay attention not to scratch the oven cavity enamel.

5. Replace the lamp with one of the same type (40W).
6. Refit the cover correctly, so that the moulded part of the glass is facing the door.
7. Press the cover completely down so that it attaches perfectly to the bulb support.

Removing the door seal

To permit thorough cleaning of the oven, the door seal may be removed. There are fasteners on all four sides to attach it to the edge of the oven. Pull the 4 edges of the seal outwards to detach the fasteners.

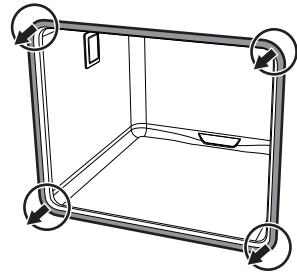



Installation

5 Installation

5.1 Electrical connection



**Power voltage
Danger of electrocution**

- Have the electrical connection performed by authorised technical personnel.
- The appliance must be connected to earth in compliance with electrical system safety standards.
- Disconnect the main power supply.

General information

Check the grid characteristics against the data indicated on the plate.

The identification plate bearing the technical data, serial number and brand name is visibly positioned on the appliance.

Do not remove this plate for any reason.

The appliance works at 220-240 V~.

Use a three-core cable (3 x 1.5 mm² cable, referring to the cross section of the internal conductor).

Perform the ground connection using a wire that is 20 mm longer than the other wires.

Connection modes:

- **220-240 V 1N~**

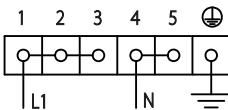

Use a **3 x 2.5 mm² three-core** cable.

- **380-415 V 2N~**

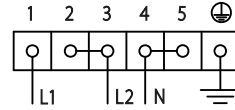

Use a **4 x 1.5 mm² four-core** cable.

- **380-415 V 3N~**

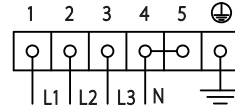

Use a **5 x 1.5 mm² five-core** cable.

Fixed connection

The device must provide for complete disconnection in category III overvoltage conditions, in compliance with the installation regulations.

Connection with plug and socket

Make sure that the plug and socket are of the same type.

Avoid using adapters and shunts as these could cause overheating and a risk of burns.



5.2 Cable replacement



Power voltage
Danger of electrocution

- Disconnect the main power supply.

1. Unscrew the fastening screws **2** of the terminal board cover.

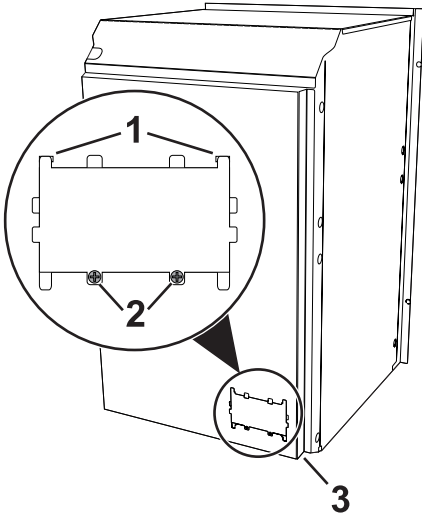

2. Slide the tabs **1** of the terminal board cover out of the grooves;
3. Loosen the screw of the cable retention bracket in the right lower part of the oven back **3**;
4. Make sure that the cables (for the oven or any hob) follow the best route in order to avoid any contact with the appliance.

5.3 Positioning



Heavy appliance
Danger of crush injuries

- Place the appliance into the piece of furniture with the aid of a second person.



Pressure on the open door
Risk of damages to the appliance

- Never use the oven door to lever the appliance into place when fitting.
- Avoid exerting too much pressure on the oven door when open.



Heat production during appliance operation
Risk of fire

- Check that the piece of furniture material is heat resistant.
- Check that the piece of furniture has the required slots.



Installation

Fixing

Screw 6 screws through the holes on the appliance sides to fasten the appliance to the unit.

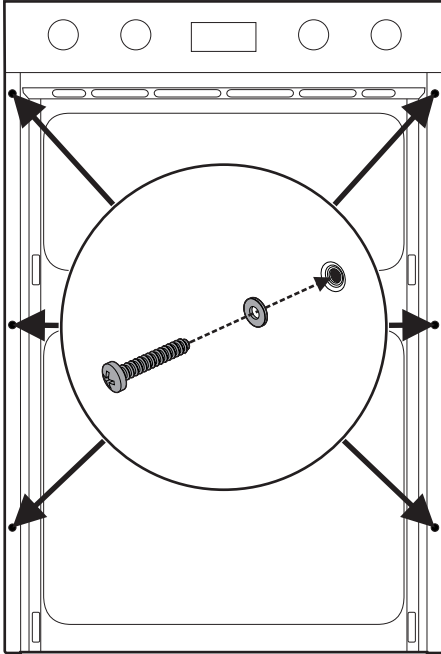

Mounting (mm)

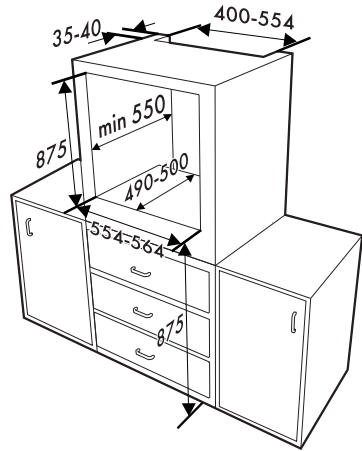

The oven is designed for mounting into any piece of furniture as long as it is heat-resistant. Respect the unit dimensions and the oven overall dimensions for positioning. Depending on the type of installation a slot should be foreseen for ventilating the appliance.

Front panel seal

Glue the supplied seal to the rear part of the front panel to avoid water or other liquids from leaking in.

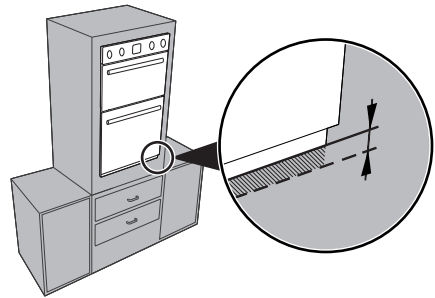
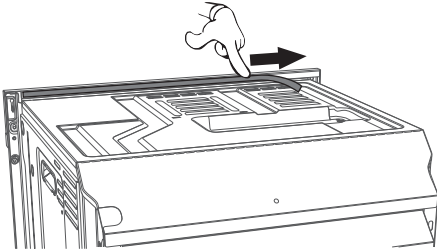

To be able to open the door completely, any unit protuberance should be at a distance of at least 1 cm from the oven.

Installation



The appliance can be mounted according to one of the following schemes:

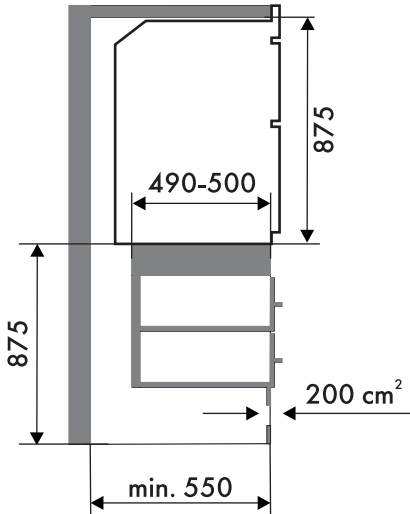

Create an opening with a total surface area of at least 200 cm² in the bottom front part of the unit.

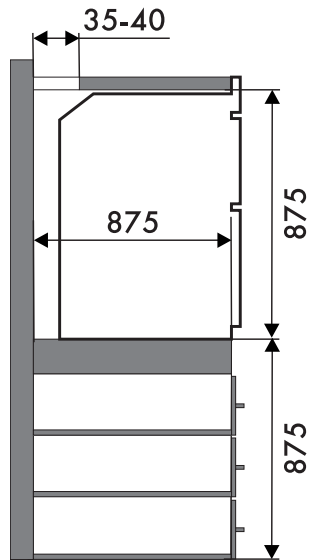

Create an opening 35-40 mm deep in the top rear part of the unit.



Installation

Appliance overall dimensions (mm)

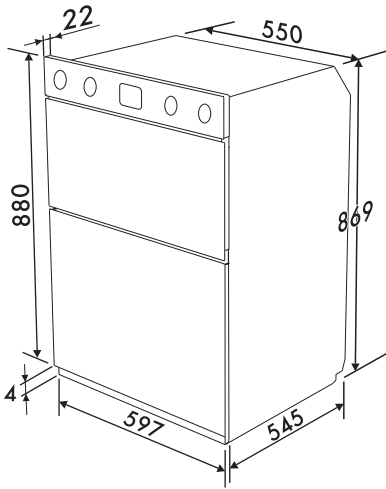

5.4 Instructions for the installer

- The plug must be accessible after installation. Do not bend or trap the power cable.
- The appliance must be installed according to the installation diagrams.
- If the appliance does not work correctly after having carried out all the checks, contact your local Authorised Service Centre.
- Once the appliance has been installed, please explain to the user how to use it correctly.

Testing

At the end of installation, carry out a brief inspection test. If the hob fails to operate, after checking that you have carried out the instructions correctly, unplug the appliance and contact Technical Support.



914778108/A