

# Contents

<b>1</b>	<b>Instructions</b>	<b>70</b>
1.1	General safety instructions	70
1.2	Instructions for using microwaves	71
1.3	Manufacturer liability	73
1.4	Appliance purpose	73
1.5	Identification plate	73
1.6	Disposal	73
1.7	This user manual	74
1.8	How to read the user manual	74
<b>2</b>	<b>Description</b>	<b>75</b>
2.1	General Description	75
2.2	Control panel	75
2.3	Other parts	76
2.4	Microwaves	76
2.5	Available accessories	77
<b>3</b>	<b>Use</b>	<b>78</b>
3.1	Instructions	78
3.2	First use	80
3.3	Using the accessories	80
3.4	Using the oven	81
3.5	Special functions	97
3.6	Preset recipes	104
3.7	Personal programs	113
3.8	Settings	117
<b>4</b>	<b>Cleaning and maintenance</b>	<b>123</b>
4.1	Instructions	123
4.2	Cleaning the surfaces	123
4.3	Ordinary daily cleaning	123
4.4	Food stains or residues	124
4.5	Drying	124
4.6	Cleaning the door glazing	124
4.7	Cleaning the inside of the oven	124
4.8	Vapor Clean	126
<b>5</b>	<b>Installation</b>	<b>130</b>
5.1	Electrical connection	130
5.2	Cable replacement	130
5.3	Positioning	131

We advise you to read this manual carefully, which contains all the instructions for maintaining the appliance's aesthetic and functional qualities.

For further information on the product: [www.smeg.com](http://www.smeg.com)



## 1 Instructions

### IMPORTANT SAFETY INSTRUCTIONS PLEASE READ CAREFULLY AND RETAIN FOR FUTURE USE.

#### 1.1 General safety instructions

##### Risk of personal injury

- **WARNING:** If the door or the door seal is damaged, the oven must not be used until it has been repaired by a competent person.
- **WARNING:** It is hazardous for anyone other than a competent person to carry out any service or repair operation which involves the removal of a cover which offers protection against exposure to microwave energy.
- **WARNING:** Liquids and other foods must not be heated in sealed containers since they are liable to explode.
- **WARNING:** During use the appliance and its accessible parts become very hot.
- Never touch the heating elements during use.
- Keep children under eight years of age at a safe distance if they are not constantly supervised.
- This appliance may be used by children aged at least 8 and by people of reduced physical and mental capacity, or lacking in experience in the use of electrical appliances, as long they are supervised or instructed by adults who are responsible for their safety.
- Children must never play with the appliance.
- The appliance must never be cleaned by unsupervised children.
- Switch off the appliance immediately after use.
- If smoke is emitted, switch off or unplug the appliance and keep the door closed in order to stifle any flames.
- Never attempt to extinguish a flame or fire with water.
- Have qualified personnel carry out installation and assistance interventions according to the standards in force.
- Do not modify this appliance.
- Do not insert pointed metal objects (cutlery or utensils) into the slots in the appliance.



- Do not try to repair the appliance yourself or without the intervention of a qualified technician.
- If the power supply cable is damaged, contact technical support immediately and they will replace it.

## Risk of damaging the appliance

- Do not use abrasive or corrosive detergents on glass parts (e.g. powder products, stain removers and metallic sponges).
- Use wooden or plastic utensils.
- Do not use a steam jet to clean the appliance.
- Do not obstruct ventilation openings and heat dispersal slots.
- Never leave the appliance unattended during cooking operations where fats or oils could be released.
- Do not use the appliance to heat rooms for any reason.
- Do not rest any weight or sit on the open door of the appliance.
- Take care that no objects are stuck in the doors.

## 1.2 Instructions for using microwaves

- Check the appliance visually during the cooking of foods in plastic or paper containers.



Improper use  
Danger of explosion



- When using the microwave to heat or reheat liquids, the boiling process may be delayed – boiling temperature can be reached without the formation of the usual "rolling boil". This delayed boiling and consequent superheating of the liquid can generate an explosion inside the appliance, or sudden boiling over of the superheated liquid can occur when removing the container from the appliance. To avoid these dangers, it is necessary to insert the supplied boiling rod (or a heat-resistant plastic spoon) in the container while heating.
- Use the microwave only for the preparation of food for consumption. Other types of applications are strictly forbidden



## Instructions

- (e.g. drying clothes, warming slippers, sponges, wet cloths or the like, dehydrating foods) because they can lead to the risk of injury or fire.
- Clean the appliance constantly and remove any food residue.
  - Do not use the microwave to dry food.
  - Do not use the microwave to heat oils or fry.
  - Do not use the appliance to heat foods or beverages containing alcohol.
  - Baby food should not be heated in sealed containers. Remove the cover or the teat (in the case of baby bottles). Always check the preparation's temperature once heating has completed, it should not be too high. For an even temperature and to avoid scalding stir or shake the contents.
  - Do not heat eggs in their shells or whole hard boiled eggs; they may explode even after the heating process has completed.
  - Before cooking food with a hard skin or peel (e.g. potatoes, apples, etc.) it is necessary to puncture the skin.
  - Do not heat food contained within food packages.
  - Do not use the microwave functions when the oven is empty.
  - Use cookware and utensils that are suitable for use in a microwave oven.
  - Do not use aluminium containers to cook food.
  - Do not use dishes with metallic decorations (gold-plated or silver).
  - The appliance operates in the 2.4GHz ISM band.
  - In compliance with the provisions relating to electromagnetic compatibility the appliance belongs to group 2 and class B (EN 55011).
  - This appliance complies with the standards and directives currently in force concerning safety and electromagnetic compatibility. It is however recommended for pacemaker wearers to maintain a minimum distance of 20-30cm between the microwave when it is operating and the pacemaker. Consult the pacemaker manufacturer for more information.



## 1.3 Manufacturer liability

The manufacturer declines all liability for damage to persons or property caused by:

- Use of the appliance other than the one envisaged;
- Non-observance of the user manual provisions;
- Tampering with any part of the appliance;
- Use of non-original spare parts.

## 1.4 Appliance purpose

- This appliance is intended for cooking food in the home environment. Every other use is considered inappropriate. It cannot be used:
  - in employee kitchens, shops, offices and other working environments.
  - in farms/agritourism establishments.
  - by guests in hotels, motels and residential environments.
  - in bed and breakfast establishments.
- The appliance is not designed to operate with external timers or with remote-control systems.

## 1.5 Identification plate

The identification plate bears the technical data, serial number and brand name of the appliance. Do not remove the identification plate for any reason.

## 1.6 Disposal



This appliance must be disposed of separately from other waste (Directives 2002/95/EC, 2002/96/EC, 2003/108/EC). The appliance does not contain substances in quantities sufficient to be considered hazardous to health and the environment, in accordance with current European directives.



### Power voltage Danger of electrocution

- Disconnect the main power supply.
- Disconnect the power cable from the electrical system.

To dispose of the appliance:

- Cut the power supply cable and remove it along with the plug (if present).
- Deliver the appliance to the appropriate recycling centre for electrical and electronic equipment waste, or return it to the retailer when purchasing an equivalent product, on a one for one basis.

Our appliances are packed in non-polluting and recyclable materials.

- Deliver the packing materials to the appropriate recycling centre.



### Plastic packaging Danger of suffocation

- Do not leave the packaging or any part of it unattended.
- Do not let children play with the packaging plastic bags.



# Instructions

## 1.7 This user manual

This user manual is an integral part of the appliance and must therefore be kept in its entirety and within the user's reach for the whole working life of the appliance.

- Read this user manual carefully before using the appliance.

## 1.8 How to read the user manual

This user manual uses the following reading conventions:

### Instructions



General information on this user manual, on safety and final disposal.

### Description



Description of the appliance and its accessories.

### Use



Information on the use of the appliance and its accessories, cooking advice.

### Cleaning and maintenance



Information for proper cleaning and maintenance of the appliance.

### Installation



Information for the qualified technician: Installation, operation and inspection.



Safety instructions



Information



Advice

1. Use instruction sequence.

- Single use instruction.



## 2 Description

### 2.1 General Description

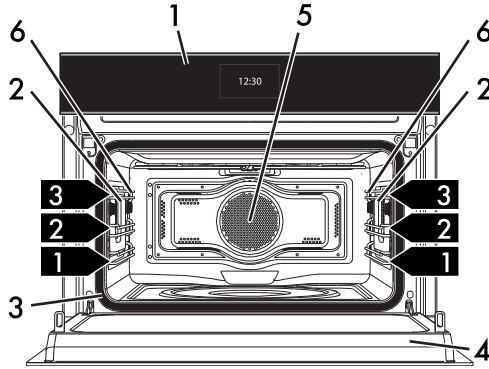

1 Control panel

2 LH light

3 Seal

4 Door

5 Oven fan

6 Rack/tray support frames

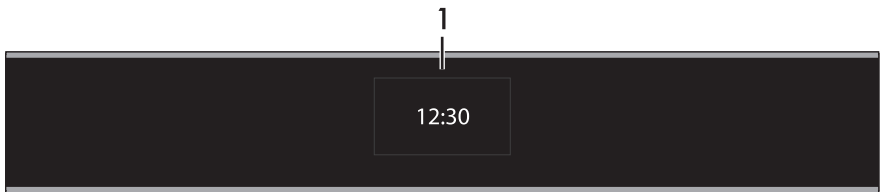

**1,2,3** Frame shelf

### 2.2 Control panel



#### 1 Display

The touchscreen display allows you to interact with the device. Press the icons to access the various available functions. The display will show all operational parameters, such as: selected function, pre-set cooking program or time/temperature settings.

In general, press the symbol  to return to the previous menu or end a function; press the symbol  to confirm the selected options.

EN



## Description

### 2.3 Other parts

#### Shelves

The appliance features shelves to position trays and racks at different heights. The insertion heights are indicated from the bottom upwards (see 2.1 General Description).

#### Cooling fan

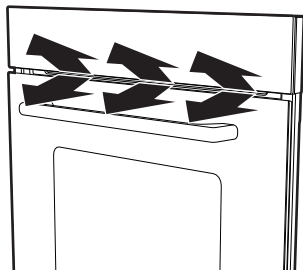





The fan cools the oven and comes into operation during cooking.

The fan causes a steady outflow of air from above the door which may continue for a brief period of time even after the appliance has been turned off.

#### Interior lighting

The appliance's interior lighting comes on:

- When the door is opened.
- When any function is selected, apart from the Sabbath  and Vapor Clean  functions.
- Press the symbol  to manually activate the oven light or the symbol  to deactivate it during use.

In order to save energy, the light turns off after a minute at the start of cooking (this function can be deactivated via the secondary menu).

### 2.4 Microwaves

The appliance is equipped with a microwave generator called a magnetron. The microwaves generated are evenly emitted into the oven cavity in order to reach the food and heat it.

Heating takes place through the process of friction between the molecules contained within the food (mainly water molecules), with the consequent generation of heat.

The heat generated directly inside the food leads to defrosting, re-heating or cooking in a shorter length of time compared to traditional cooking.

The use of suitable containers for microwave cooking allows the microwaves to reach the food in a uniform manner (see Materials suitable for microwaves).





## 2.5 Available accessories

**i** Some models are not provided with all accessories.

### Rack

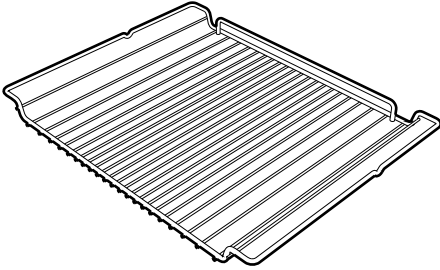

Useful for supporting containers with food during cooking.

### Glass dish

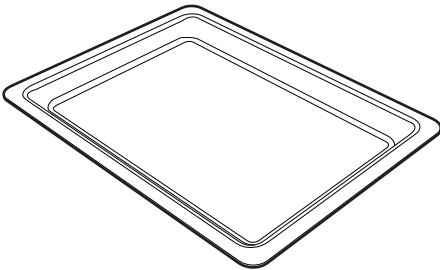

Useful for any type of cooking and collecting fat from foods resting on the rack above.

### Tray rack

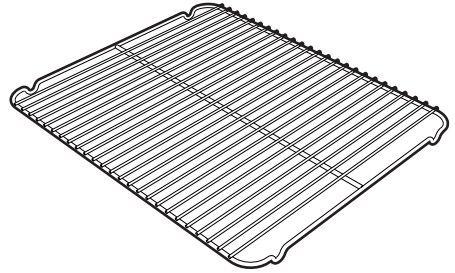

To be placed over the top of the oven tray; for cooking foods which may drip.

### Boiling rod



To be placed in containers when heating liquids, necessary to avoid delayed boiling with resulting superheating.

**i** The oven accessories intended to come into contact with food are made of materials that comply with the provisions of current legislation.

**i** Original supplied and optional accessories can be requested to Authorised Assistance Centres. Use only original accessories supplied by the manufacturer.



## 3 Use

### 3.1 Instructions



**High temperature inside the oven during use**

**Danger of burns**

- Keep the oven door closed during cooking.
- Protect your hands wearing heat resistant gloves when moving food inside the oven.
- Do not touch the heating elements inside the oven.
- Do not pour water directly onto very hot trays.
- Do not allow children to approach the oven when it is in operation.



**High temperature inside the oven during use**

**Danger of fire or explosion**

- Do not spray any spray products near the oven.
- Do not use or leave flammable materials near the oven.
- Do not use plastic kitchenware for cooking food (except with the microwave function).
- Do not put sealed tins or containers in the oven.
- Do not leave the oven unattended during cooking operations where fats or oils could be released.
- Remove all trays and racks which are not required during cooking.



**Improper use**

**Risk of damage to enamelled surfaces**

- Do not cover the bottom of the oven cavity with aluminium or tin foil sheets.
- If you wish to use greaseproof paper, place it so that it will not interfere with the hot air circulation inside the oven.
- Do not bang or drag cookware over the glazed bottom of the oven cavity.
- Do not pour water directly onto very hot trays.

### **Materials suitable for microwaves**

In general, in order for all of the food to be reached, the materials used for microwave cooking must be transparent to microwave energy.



Below is a table of materials to use and those not to use:

### MATERIALS TO USE

#### Glass\*

- Baking ware Always remove the covers.
- Glasses
- Glass jars

#### Porcelain

#### Ceramic

#### Plastic\*

- Containers Only where suitable for microwave use.
- Plastic wrap Where film is used it must not come into contact with the food.

\*only if heat-resistant

### NOT TO BE USED

#### Metal

- Aluminium foil
- Aluminium trays These can lead to arcing or sparks.
- Plates
- Metal utensils
- Freezer bags tie wraps

#### Wood

#### Crystal glasses

#### Paper

Risk of fire.

#### Expanded polystyrene containers

Risk of food contamination.

\*only if heat-resistant



Dishes must be free of metal decorations.

### Testing dishes



The microwave function can be used without any food inside the oven only for this test.

To check whether or not cookware is suitable for use with microwave cooking carry out this simple test:

1. Remove all accessories from the oven cavity.
2. Place the cookware to be tested on the rack inserted in the first runner.
3. Select the maximum power level (e.g. 1000W).
4. Set a cooking time of 30 seconds.
5. Start cooking.



#### Unsuitable cookware

#### Risk of damage to the appliance

- If there is crackling or if sparks are emitted from the cookware then immediately terminate the test. In this instance the cookware is not suitable for microwave cooking.
6. At the end of the test the cookware must be either cold or slightly warm. If the cookware is hot then it should be considered as unsuitable for microwave use.



## 3.2 First use

1. Remove any protective film from the outside or inside of the appliance, including accessories.
2. Remove any labels (apart from the technical data plate) from the accessories and from the oven cavity.
3. Remove and wash all the appliance accessories (see 4 Cleaning and maintenance).
4. Heat the empty oven at maximum temperature (using the traditional functions) so as to remove any manufacturing residues.

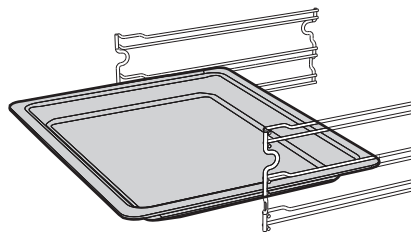

**High temperature  
Danger of burns**

- When using any of the microwave functions the rack can become very hot. Use heat-proof gloves for handling.



For the first reheating use a traditional function and not a microwave function.



Gently insert racks and trays into the oven until they come to a stop.



Clean the trays before using them for the first time to remove any residues left by the manufacturing process.

## 3.3 Using the accessories

### Racks and trays

Racks and trays have to be inserted into the side guides until they come to a complete stop.

- The mechanical safety locks that prevent the rack from being taken out accidentally have to face downwards and towards the oven back.

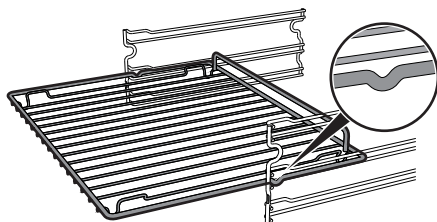

### Tray rack

The tray rack has to be inserted into the tray. In this way fat can be collected separately from the food which is being cooked.

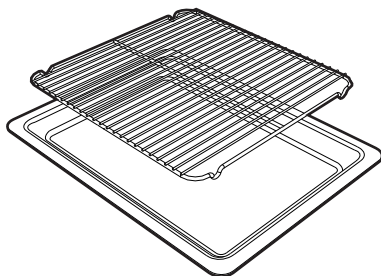



## Boiling rod

When using the microwave to heat or reheat liquids, the boiling process may be delayed while the liquids nevertheless exceed 100 degrees. To avoid this dangerous phenomenon, it is necessary to insert the supplied boiling rod (or a heat-resistant plastic spoon) in the container while heating.



### Improper use Danger of explosion/burns

- To avoid the danger of explosion inside the appliance or the sudden boiling over of superheated liquids, it is always necessary to immerse the boiling rod in the liquid being heated.



### High temperature Risk of damage to the accessory

- Use the boiling rod only with Microwave functions. The rod must not be used with combination and traditional functions.

## 3.4 Using the oven

### First use

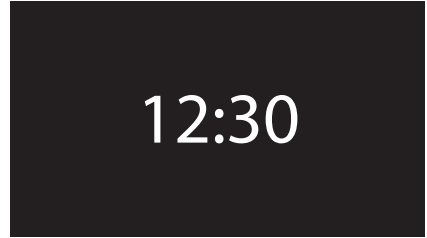

On the first use, or after a power failure, **00:00** will be flashing on the appliance's display. In order to be able to start any cooking operation, the current time must be set (if the oven is being turned on for the first time, it is also recommended you set the required language).

Touch the display to enter the settings menu.



The appliance language is set to "English" by default.



When first connecting or after the power has been cut for a time it will be necessary to wait a few seconds before you can interact with the appliance.



# Use

## Home screen

Press the time on the display. It is now possible to select the various available functions on the home screen of the appliance.

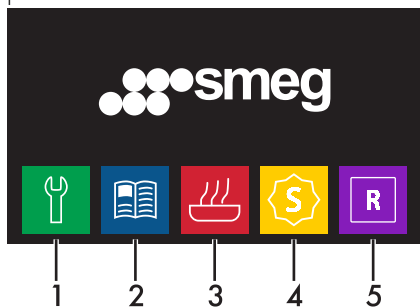

- 1 Settings
- 2 Preset recipes
- 3 Cooking functions
- 4 Special functions
- 5 Personal programs

## Microwave functions



**Improper use**  
**Risk of damage to the appliance**

When using the microwave functions, food must be placed in a suitable container on the rack inserted in the first runner.

**DO NOT USE CONTAINERS/ACCESSORIES (trays, glass dishes, etc.) PLACED DIRECTLY ON THE FLOOR OF THE OVEN.**

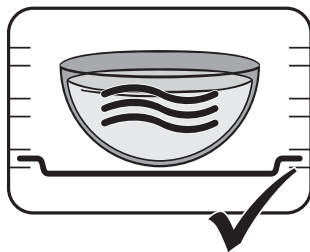
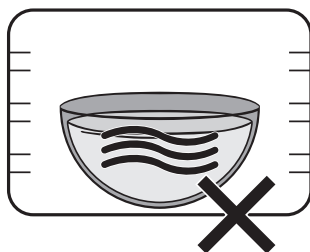

For perfect results with long microwave and combination cooking functions, food should be stirred once or twice during cooking.



1. Place the dish into the oven cavity.
2. Select the **cooking functions**  icon on the "home screen".



3. Select the required function.

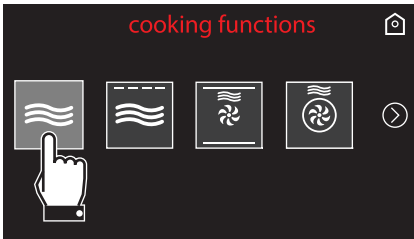

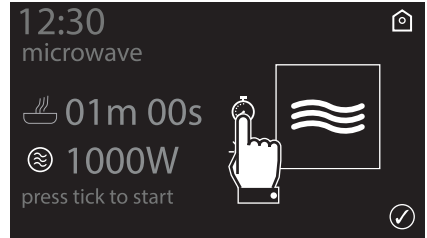

 When cooking using only the microwave function, the appliance does not perform preheating. The food can be placed immediately inside the appliance.

4. Press the symbol  to change the cooking time.

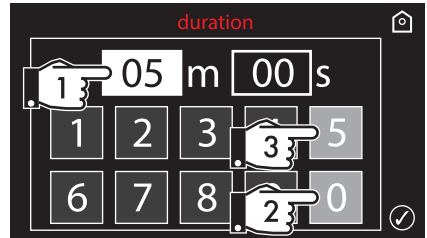

5. Enter the required duration (for example 5 minutes: first touch the minutes box, then the numbers 0 and 5).



6. Press the symbol  to confirm.

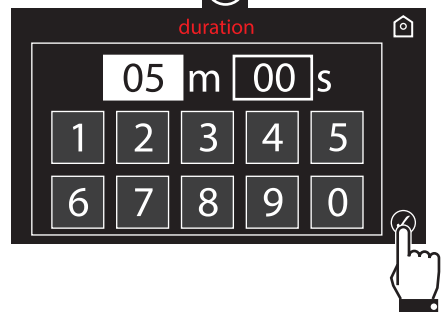

EN



## Use

7. Press the symbol  to change the microwave power level (from 100W to 1000W).

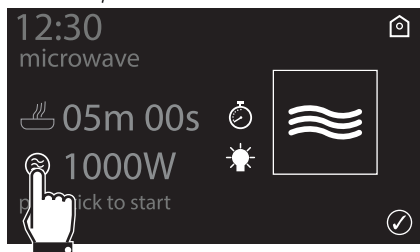

8. Use the symbols  and  to set the required temperature (e.g. 900 W).

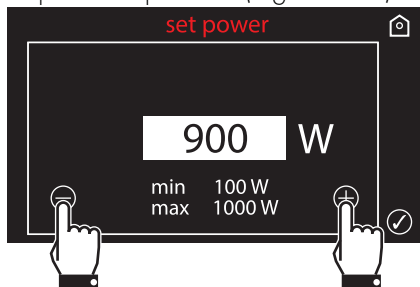

9. Press the symbol  to confirm.

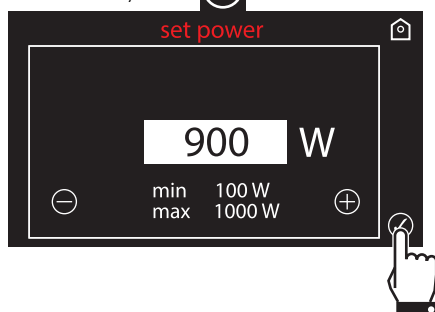

10. Press the symbol  to start microwave cooking.

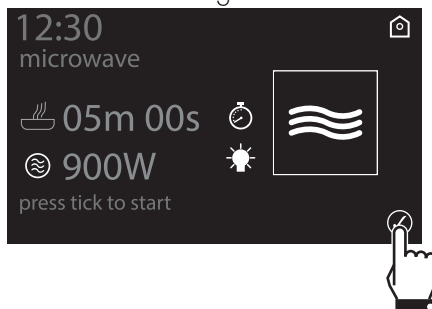

11. The chosen function, the selected power level, the current time and the time remaining until the end of the function will be shown on the display.

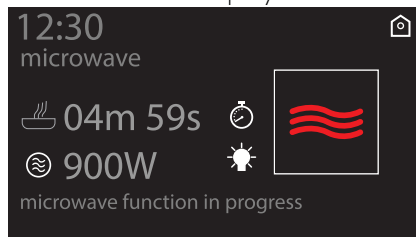





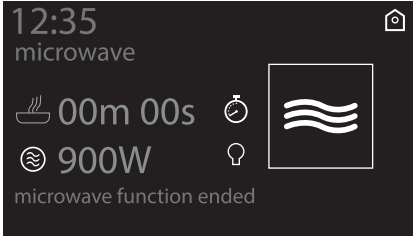

12. At the end of the cooking cycle, “microwave function ended” appears on the display and a buzzer will sound that can be deactivated by pressing the

symbol  or .



Press and hold the return symbol  for a few seconds to immediately interrupt cooking at any time and return to the main menu.

### Microwave power levels

Below is a list of the power levels that can be selected:

Power (W)	Useful for
100	Defrosting food
200	
300	
400	Cooking meat or delicate cooking
500	
600	Re-heating and cooking food
700	
800	
900	
1000	Heating liquids



# Use

## Combination functions



Combination cooking is a mix of traditional cooking and microwave operation.

## Combination functions list



**Improper use**  
**Risk of damage to the appliance**

- Do not use the combination functions to heat or boil liquids.



### Microwave + Grill

The use of the grill results in perfect browning of the food's surface. Using the microwave on the other hand leads to rapid internal cooking of the food.



### Microwave + static + fan

The operation of the fan, combined with traditional cooking, ensures consistent cooking even with complex recipes. Using the microwave on the other hand leads to rapid internal cooking of the food.



### Microwave + Circulaire

For combination cooking of food in a short time thanks to the microwave action working together with hot air circulation.

- Select the **cooking functions**  icon on the "home screen".



- Select the required "combination" function.

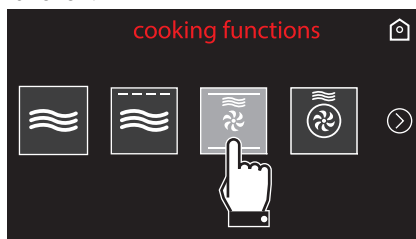



The display shows the screen for setting the parameters of the selected combination function.



With the combination Microwave+Grill function, given the type of cooking and in order to cook more quickly preheating is not performed.



At this point it is possible to modify:

- The cooking duration (press the symbol ).
  - The cooking temperature (press the temperature value, 170° in the example in the figure).
  - The microwave power (press the symbol ).
3. When you have finished making the required modifications, press the symbol  to activate the set combination cooking function.

The appliance will begin preheating. The display will show the chosen function, the pre-set temperature, the current time and the progress bar of the temperature reached (preheating).



When the preheating stage is over a buzzer will sound to indicate that the food can be placed inside the oven.

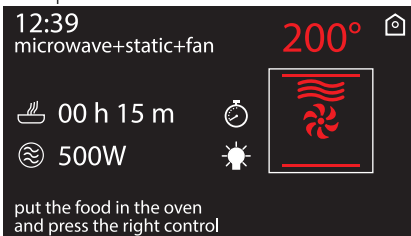

4. After placing the food in the oven, press the control knob to start cooking.

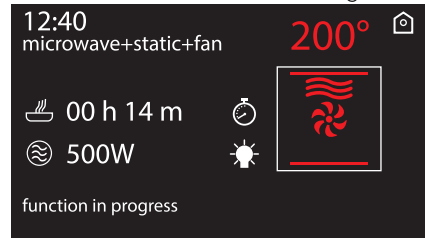

Press and hold the return symbol  for a few seconds to immediately interrupt cooking at any time and return to the main menu.



## Traditional functions

1. Select the **cooking functions**  icon on the "home screen".



2. Press the symbol  to access the traditional functions menu.



3. Select the required function.

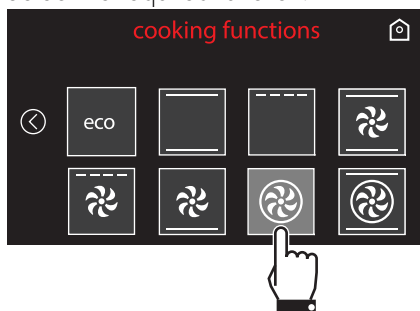

4. The appliance will begin preheating. The display will show the chosen function, the pre-set temperature, the current time and the progress bar of the temperature reached (preheating).



5. When the preheating stage is over, a buzzer will sound to indicate that the food can be placed inside the oven.



Press and hold the return symbol  for a few seconds to immediately interrupt cooking at any time and return to the main menu.



## Changing a function during cooking

1. Press the symbol corresponding to the function you wish to modify.

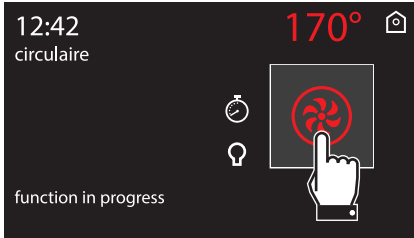

2. Press the symbol  to access the traditional functions menu.

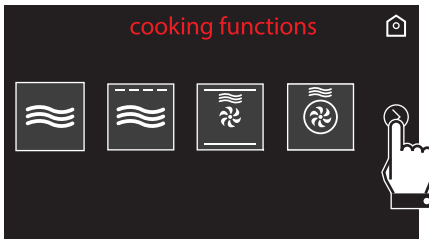

3. Press the symbol of the new function required.



4. The display will show the new function chosen, the preset temperature, the current time and the progress in reaching the new temperature.

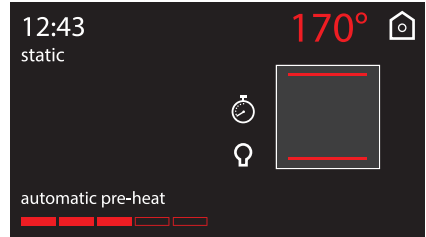

## Modifying the preset temperature

1. Press the displayed temperature to change it.



2. Use the symbols  and  to set the required temperature.

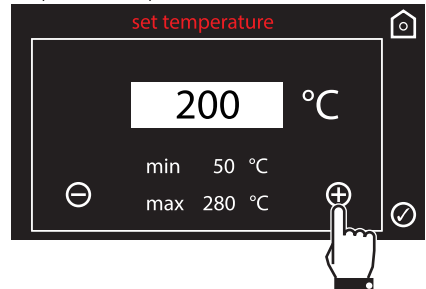



## Use

3. Press the symbol  to confirm.

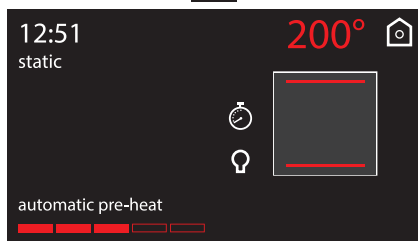

### Interrupting a function

Press the return symbol  for approximately 2 seconds to interrupt a cooking function. Select the required option.

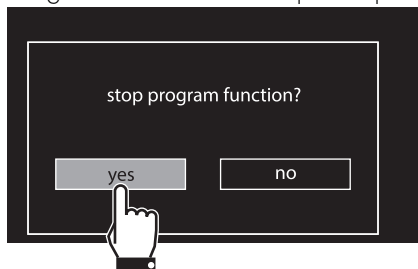



Press and hold the return symbol  for a few seconds to immediately interrupt cooking at any time and return to the main menu.

### Traditional functions list

 **Eco**  
The combination of the fan and the circulaire heating element, in ECO mode, is particularly indicated for cooking on a single shelf, with reduced power consumption.

 **Static**  
As the heat comes from above and below at the same time, this system is particularly suitable for certain types of food. Traditional cooking, also known as static cooking, is suitable for cooking just one dish at a time. Ideal for pies, bread and casseroles. It is also suitable for fatty meat such as duck and goose.

 **Grill**  
The heat coming from the grill element gives perfect grilling results above all for thin and medium thickness meat and, in combination with the rotisserie (where fitted), gives the food an even browning at the end of cooking. Ideal for grilled cheese and gratinating. This function enables large quantities of food, particularly meat, to be grilled evenly.

 **Fan assisted**  
The operation of the fan, combined with traditional cooking, ensures consistent cooking even with complex recipes. Perfect for roasts.



### Fan with grill

The air produced by the fan softens the strong heatwave generated by the grill, perfectly grilling even very thick cuts of meat such as steaks, pork chops, etc.



### Fan + lower element

The combination of the fan with just the lower heating element allows cooking to be completed more rapidly. This system is recommended for sterilising or for finishing off the cooking of foods which are already well-cooked on the surface, but not inside, which therefore need a little more heat. Perfect for any type of food.



### Circulaire

The combination of the fan and the circulaire heating element (incorporated in the rear of the oven) allows you to cook different foods on several levels, as long as they need the same temperatures and type of cooking. Hot air circulation ensures instant and even distribution of heat. It will be possible, for instance, to cook fish, vegetables and biscuits simultaneously (on different levels) without odours and flavours mingling.



### Turbo

The combination of fan assisted cooking and traditional cooking allows different foods to be cooked on several levels extremely quickly and efficiently, without odours and flavours mingling. Perfect for large volumes that call for intense cooking.

To obtain a rotisserie effect, set the temperature to maximum. When the appliance reaches maximum temperature, return the temperature to normal. This procedure seals the liquids inside the meat, and reduces shrinkage.



## Use

### Timer during function



This function only activates the buzzer, without stopping cooking.

1. Press the symbol  during a cooking function.
2. Press on **timer**.

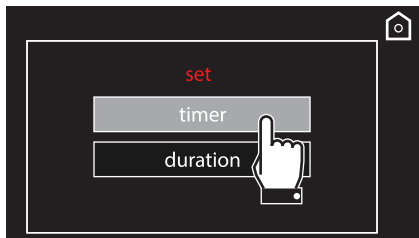

The duration of the timer can be from a minimum of 1 minute to a maximum of 4 hours.

3. Enter the required duration (for example 25 minutes: first touch the minutes box, then the numbers 2 and 5).



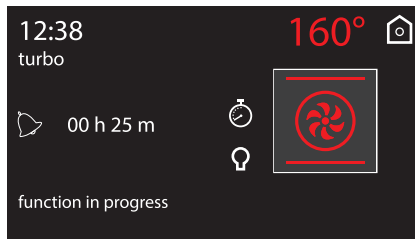

4. Press the symbol  to confirm.

5. The countdown will start.



6. Wait for the buzzer to indicate that the time has finished. The symbol  flashes.



Press the symbol  or  to deactivate the buzzer. Press the symbol  again to select another timer.





## Timed cooking

**i** Timed cooking is the function which allows a cooking operation to be started and then ended after a specific length of time set by the user.

**i** Activation of timed cooking cancels any minute minder timer which may previously have been set.

1. Press the symbol  during a cooking function.
2. Press on **duration**.

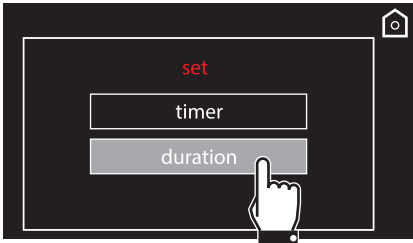

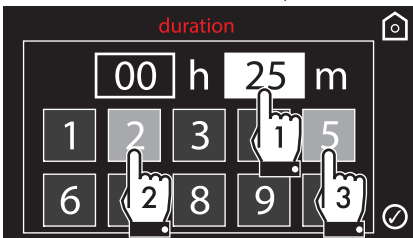

**i** The duration of the minute minder can be from a minimum of 1 minute to a maximum of 13 hours.

3. Enter the required duration (for example 25 minutes: first touch the minutes box, then the numbers 2 and 5).



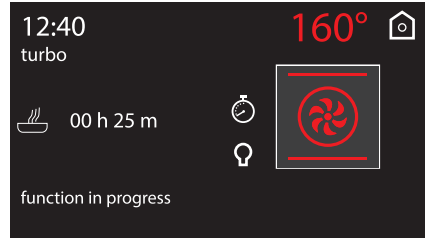

4. Press the symbol  to confirm.
5. Timed cooking begins.

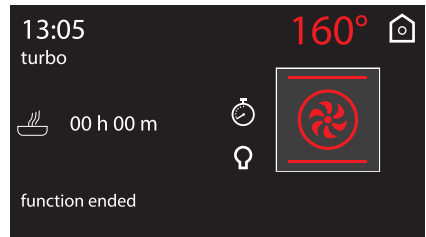

6. At the end of the cooking cycle, "function ended" appears on the display and a buzzer will sound that can be deactivated by pressing the symbol  or .



 To manually extend the cooking cycle, press the symbol  followed by the symbol . The appliance will resume its normal operation with the previously selected cooking settings.



## Modifying the data set during timed cooking

During operation, it is possible to modify timed cooking duration:

1. Press the symbol .
2. Press on **duration**.

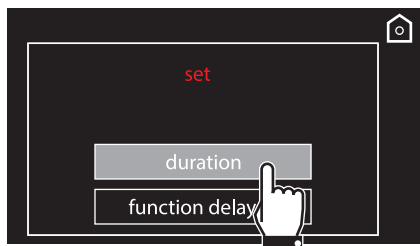

3. Enter the new duration required and press the symbol  to confirm.

## Delay cooking

**i** Delay cooking is the function which allows a cooking operation to be stopped at an established time depending on the time set by the user, after which the oven will switch off automatically.

1. After setting a cooking duration, press the symbol .
2. Press on **delay cooking**.

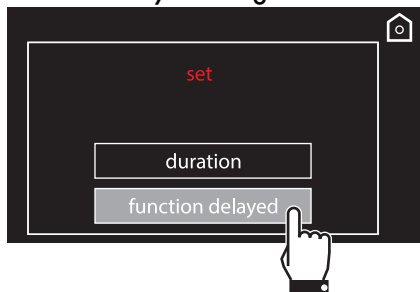

3. Enter the time at which you require cooking to end (for example at 19:30:

first touch the hours box, then the numbers 1 and 9; touch the minutes box, then the numbers 3 and 0).

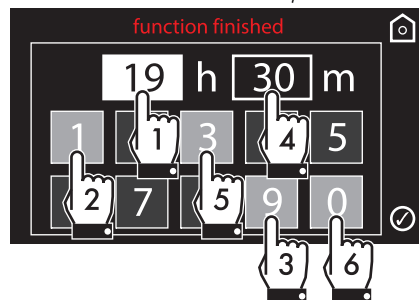

4. Press the symbol  to confirm.
5. The appliance waits for the delay start time.

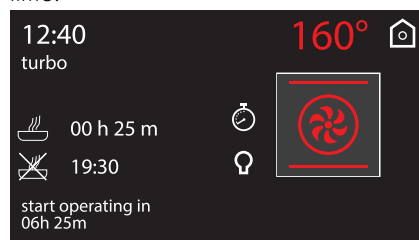



6. Based on the values set, the appliance will start a preheating stage of approximately 10 minutes.





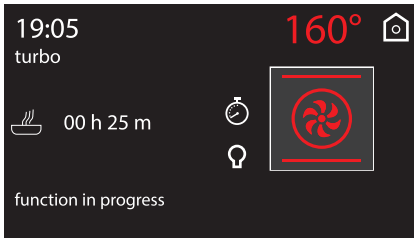

7. It will then proceed with the selected function.

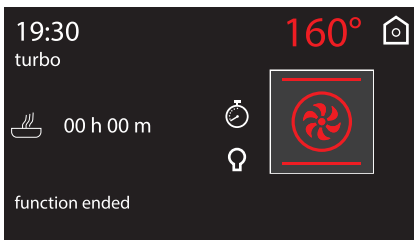

8. At the end of the cooking cycle, "function ended" appears on the display and a buzzer will sound that can be deactivated by pressing the symbol 

or .



To manually extend the cooking cycle, press the symbol  followed by the symbol . The appliance will resume its normal operation with the previously selected cooking settings.





For safety reasons, it is not possible to set the cooking end time by itself without setting the cooking duration.

## Modifying the data set during programmed cooking





After modifying the cooking duration, the end of cooking time must be re-set.

During operation, it is possible to modify programmed cooking duration:

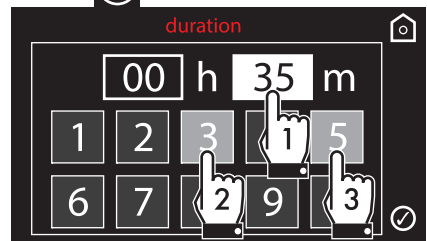
1. Press the symbol .
2. Enter the new duration required (for example 35 minutes) and press the symbol .



3. Press the symbol  again.
4. Enter the new cooking end time required (for example 19:00) and press the symbol .

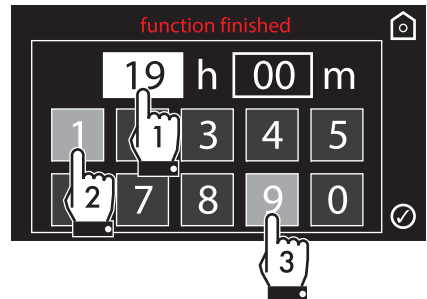



## Traditional cooking tips

### General advice

- Use a fan assisted function to achieve consistent cooking at several levels.
- It is not possible to shorten cooking times by increasing the temperature (the food could be overcooked on the outside and undercooked on the inside).

### Advice for cooking meat

- Cooking times vary according to the thickness and quality of the food and to consumer taste.
- Use a meat thermometer when roasting meat, or simply press on the roast with a spoon. If it is hard, it is ready; If not, it needs another few minutes cooking.

### Advice for cooking with the Grill and the Fan with grill

- Meat can be grilled even when it is put into the cold oven or into the preheated oven if you wish to change the effect of the cooking.
- With the Fan with grill function, we recommend that you preheat the oven before grilling.
- We recommend placing the food at the centre of the rack.

## Advice for cooking desserts/pastries and biscuits

- Use dark metal moulds: They help to absorb the heat better.
- The temperature and the cooking time depend on the quality and consistency of the dough.
- To check whether the dessert is cooked right through: At the end of the cooking time, put a toothpick into the highest point of the dessert. If the dough does not stick to the toothpick, the dessert is cooked.
- If the dessert collapses when it comes out of the oven, on the next occasion reduce the set temperature by about 10°C, selecting a longer cooking time if necessary.

### To save energy

- Stop cooking a few minutes before the time normally used. Cooking will continue for the remaining minutes with the heat which has accumulated inside the oven.
- Reduce any opening of the door to a minimum to avoid heat dispersal.
- Keep the inside of the appliance clean at all times.



### 3.5 Special functions

The special functions menu contains some functions like the timer with the oven off, defrosting or cleaning functions.

Select the **special functions**  icon on the "home screen".



#### List of special functions



##### Timer

This function sounds a buzzer when the time set has elapsed.



##### Defrost by weight

This function defrosts foods on the basis of the type and weight of the frozen product.



##### Defrost by time

This function allows you to defrost food on the basis of a selectable time.



##### Proving

The proving function, using the heat coming from the top, makes it possible to prove all types of dough, guaranteeing perfect results quickly.



##### Reheat

This function allows you to reheat previously cooked food kept cool or in the refrigerator.



##### Sabbath

This function allows food to be cooked in accordance with the provisions of the Jewish religion day of rest.



##### Vapor Clean

This function facilitates cleaning using the steam produced by a small quantity of water poured onto the bottom of the oven. (See "Cleaning and maintenance").



The more complex special functions are illustrated below. For the Vapor Clean function, see "4 Cleaning and maintenance".



# Use

## Timer

**i** The duration of the minute minder can be from a minimum of 1 minute to a maximum of 4 hours.

1. Select **timer** from the “special functions” menu.

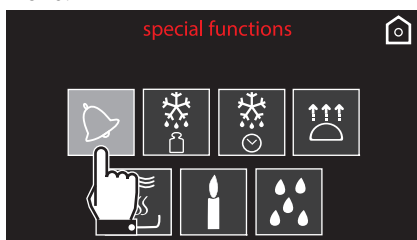



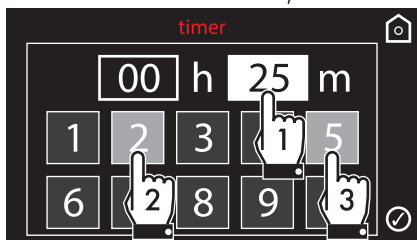

2. Enter the required duration (for example 25 minutes: first touch the minutes box, then the numbers 2 and 5).

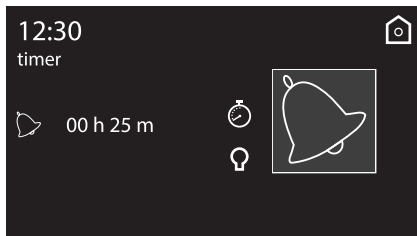

3. Press the symbol  to confirm.
4. The countdown will start.



5. Wait for the buzzer to indicate that the time has finished. The symbol  flashes.

 Press the symbol  or  to deactivate the buzzer. Press the symbol  again to select another timer.

6. If you leave the timer setting screen, the symbol  will be displayed at the top left, indicating that a timer is active.

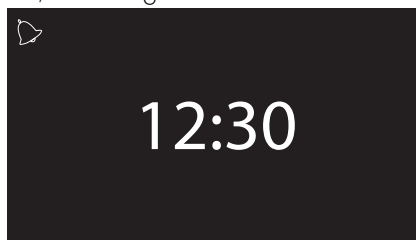

 You must return the counter to zero to remove the special timer.

**i** If a function is activated after setting a timer time, this time will be automatically used as a timer for the function, except for some special functions, automatic programs and personal recipes.

**i** This function only activates the buzzer, without stopping cooking.



## Defrost by weight

1. Place the food inside the appliance.
2. Select **defrost by weight** from the "special functions" menu.



3. Select the type of food to defrost.

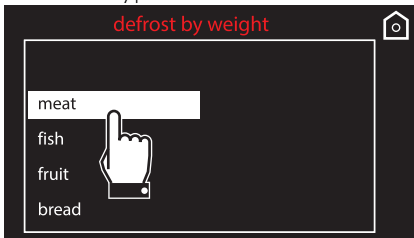

4. Use the symbols **+** and **-** to enter the weight (in kilograms) of the food to defrost.

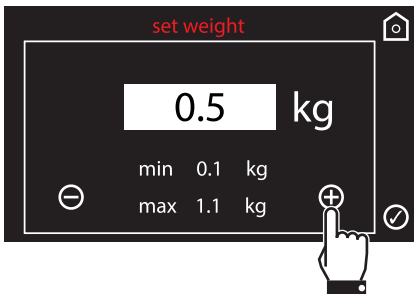

5. Press the symbol **✓** to confirm.

6. Select **start** to start defrosting, or select **change** to further modify the set parameters.

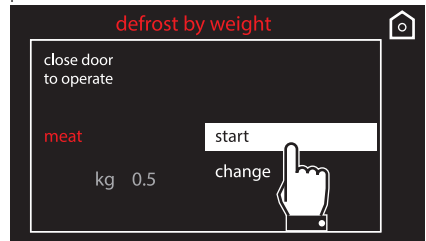

7. Press the symbol **✓** to start the defrost by weight function.
8. The defrost by weight will start.



9. At the end of the function, "function ended" appears on the display and a buzzer will sound that can be deactivated by pressing the symbol **Ⓛ**.

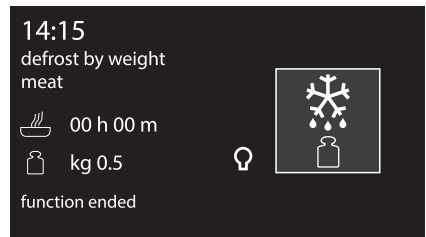



# Use

Pre-set parameters:

Type	Weight (kg)	Time
Meat	0.5	01h 45m
Fish	0.4	00h 40m
Fruit	0.3	00h 45m
Bread	0.3	00h 20m

## Defrost by time

1. Place the food inside the appliance.
2. Select **defrost by time** from the "special functions" menu.



3. Enter the required duration (for example 1 hour: first touch the hours box, then the numbers 0 and 1).

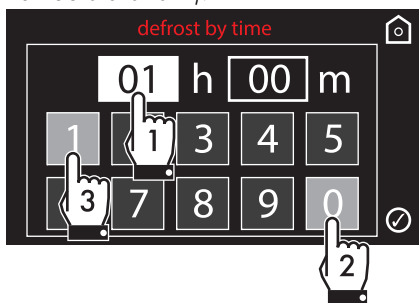

4. Press the symbol  to confirm.

5. Press the symbol  again to start the defrost by time function.

6. The defrost by time will start.



7. While the function is in progress, it is possible to further modify the defrosting duration (see "Timed cooking"). Press the symbol  to make the desired changes.

8. At the end of the function, "function ended" appears on the display and a buzzer will sound that can be

deactivated by pressing the symbol .

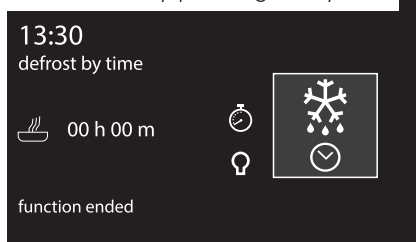

 The duration of the defrost by time can be from a minimum of 1 minute to a maximum of 13 hours.





## “Turn” procedure

For best defrosting results it is recommended, when necessary, to turn the dish inside the oven cavity.

1. Put the dish in the oven placing it parallel to the door.

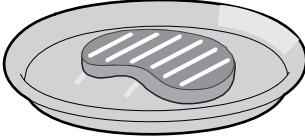

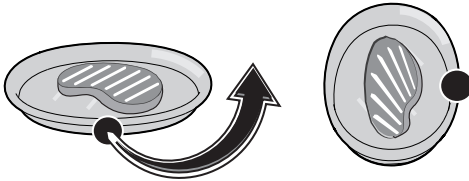

2. When the instruction “open door and rotate dish” is displayed, it is necessary to turn the dish.

3. Open the door and turn the dish 90°.

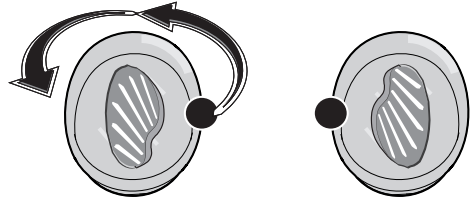

4. Close the appliance door and press the symbol  to resume the function.
5. If necessary the appliance will again ask for rotation of the dish. The display will show the instruction “open door and rotate dish”.
6. For the second rotation the door will need to be opened and the dish turned by 180°.



7. Close the door and press the symbol  to resume the function.



If dish rotation is not performed the appliance will wait for one minute and then automatically continue defrosting.



# Use

## Proving

**i** For successful proving, a container of water should be placed in the bottom of the oven.

1. Position the dough to prove on the second level.
2. Select **proving** from the “special functions” menu.

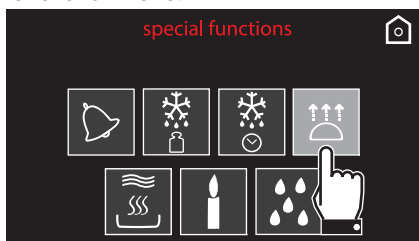

3. Press the symbol to start the proving function.
4. The appliance will begin preheating.



5. It will then proceed with the selected function.



6. While the function is in progress, it is possible to set a timer for a maximum of 4 hours (see “Microwave functions”), a proving duration (see “Timed cooking”) or delayed proving (see “Delay cooking”). Press the symbol to make the desired changes.

**i** Unless otherwise set, the proving will have a maximum duration of 13 hours.

**i** For optimum proving, the oven light is kept off, but it can be turned on at any time with the symbol .

At the end of the function, “function ended” appears on the display and a buzzer will sound that can be deactivated by pressing the symbol .

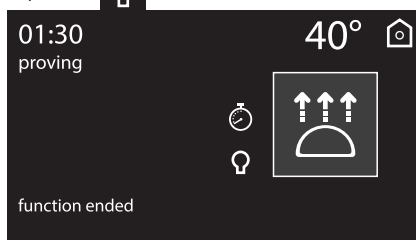

It is not possible to modify the default temperature of the proving function (40°C).





## Reheat

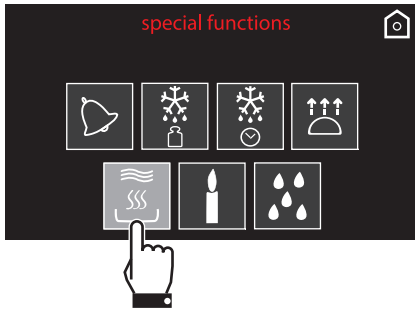

This function allows you to heat previously cooked food which has been kept cool or in the refrigerator.

1. Place the food to be heated inside the appliance.
2. Select **reheat** from the “special functions” menu.



3. Press the symbol  to modify the reheating time.
4. Press the symbol  to start reheating.

## Sabbath



This function results in the appliance operating in a particular way:

- Cooking can proceed indefinitely, it is not possible to set any cooking duration.
- No preheating will be performed.
- The cooking temperature which can be selected varies between 60-100 °C.
- Oven light disabled, any operation such as opening the door or manual activation will not activate the light.
- The internal fan remains turned off.
- Buzzers disabled.



After activating the Sabbath function the settings cannot be altered.

Any action will produce no effect; only the return symbol  remains active to allow you to return to the main menu.



## Use

1. Select **sabbath** from the “special functions” menu.

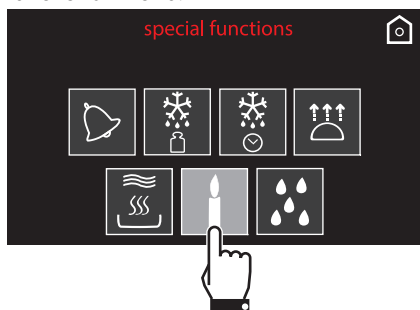

2. Press the symbol  to start the Sabbath function, or press the preset temperature value to change it (from 60° to 100° C).



3. When finished, press and hold the return symbol  to return to the main menu.

### 3.6 Preset recipes

This mode allows you to select a pre-set food cooking program. The appliance will automatically calculate the optimum cooking parameters based on the weight entered.

Select the **preset recipes**  icon on the “home screen”.





In this function, cooking itself is preceded by a preheating stage, which allows the oven to heat to the cooking temperature more quickly.

When the preheating stage is over a buzzer will sound to indicate that the food can be placed inside the oven. Introduce the food and then press the function knob to proceed with cooking.



## Starting a preset recipe

1. Press the symbols  and  to select the type of dish required from the "preset recipes" menu. Then press the name of the dish to confirm.

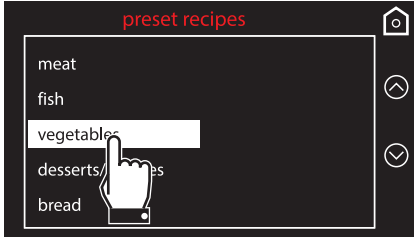

2. Select the sub-type of dish to cook and press the name of the sub-type of dish to confirm.

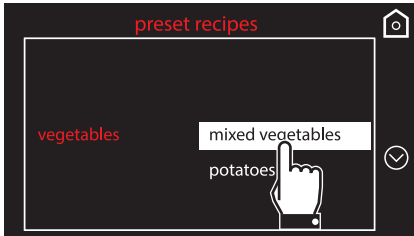

3. Select the type of cooking (where possible, depending on the dish chosen) and press the name of the cooking type to confirm.

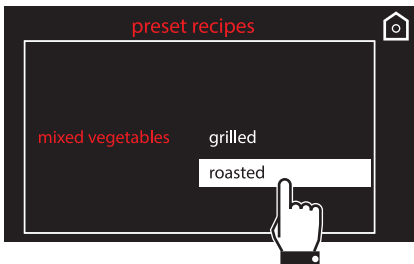

4. Press the symbol  to change the weight of the dish.



5. Use the symbols  and  to enter the weight (in kilograms) of the dish.

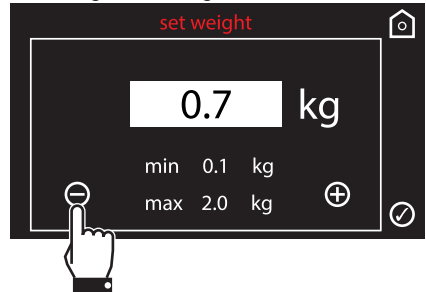

6. Press the symbol  to confirm.

7. Press the symbol  again to move to the next screen.

8. At this point it is possible to start the selected preset recipe, permanently modify the settings or perform delay cooking.





## Use

9. If you choose the **start** option, cooking will start with the preset recipe's predefined settings and the display will show all the parameters set.

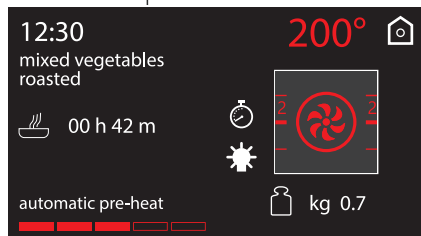

10. A buzzer will sound and a message will be displayed to indicate when to place the food in the oven and enable the start of cooking.

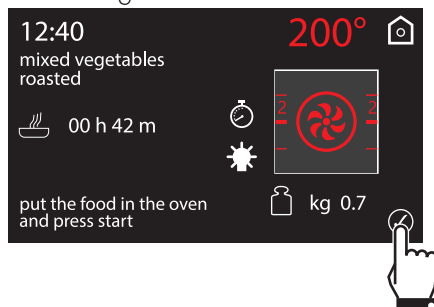

11. Press the symbol  to start cooking.

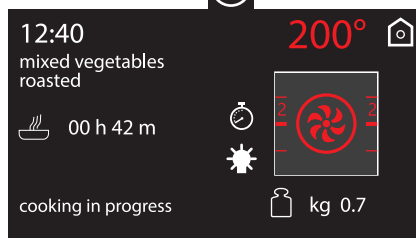

The time shown does not include the time to reach temperature.





Some predefined cooking parameters can be changed at any time, even after cooking has started.

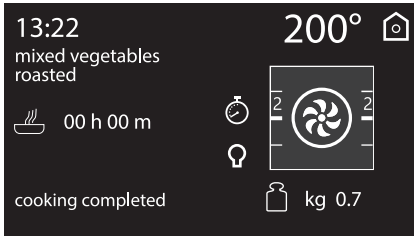

## End of a preset recipe

1. At the end of the preset recipe, the appliance will notify the user with a buzzer and the symbol  will flash.



2. To cook again with the previously set parameters, press the symbol  (press twice if the buzzer is active). The appliance will begin cooking again automatically if it is still at temperature, otherwise it will start preheating.



Cooking in sequence is useful for cooking multiple dishes of the same type. For example, cooking several pizzas in quick succession.



It is not recommended to place food in the oven during the preheating stage. Wait for the corresponding message.

3. Press and hold the return symbol  to exit and end the preset recipe.

## Permanently modifying a preset recipe

1. Inside the selected preset recipe, select **change** from the menu of the selected dish.



- All parameters which can be changed will be highlighted in yellow on the main screen.

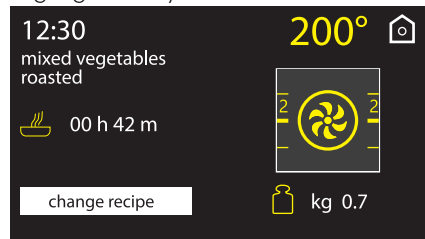

2. Press the parameter you wish to change:
  - Cooking temperature

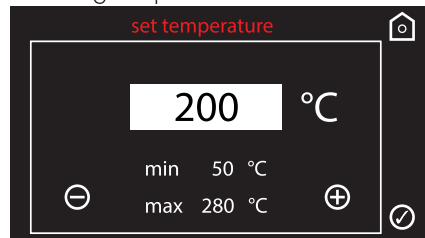



# Use

- Cooking function



- Cooking duration

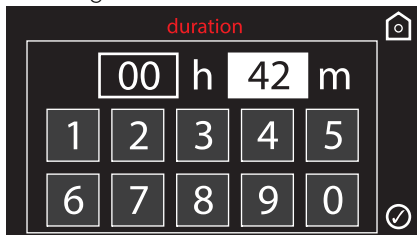

- Oven shelf



- Weight of dish

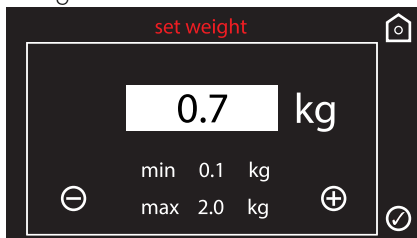

3. Make the required changes.

4. Press the symbol  to store the recipe.

The appliance will ask to confirm the changes which have just been made.

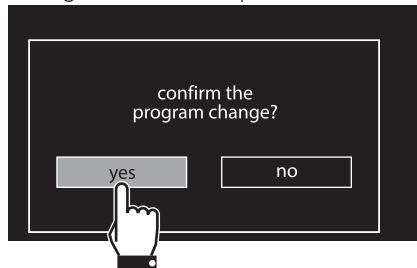

**i** If the modifications are not confirmed, the preset recipe will remain unchanged.

5. If the change is confirmed the display will show confirmation of this.

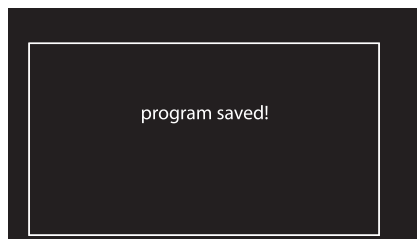





## Predefined programs table







### MEATS

Subcategory	Cooking	Weight (Kg)	Function	MW (W)	Shelf	Temp. (°C)	Time (minutes)
Roast beef	Rare	1		-	1	200	50
	Medium	1		-	1	200	60
	Well done	1		-	1	200	90
Roast pork	Fresh	1		300	1	190	60
Lamb	Medium	1.2		300	1	190	55
	Well done	1.2		300	1	190	60
Veal	Fresh	1		300	1	190	70
Pork spare ribs	Fresh	1		-	3	250	16
Pork chops	Fresh	1		-	3	250	15
Pork sausages	Fresh	1		-	3	250	12
Bacon	Fresh	0.5		-	3	250	7
Roast turkey	Fresh	1		300	2	200	55
Roast chicken	Fresh	1		300	2	200	50
Roast rabbit	Fresh	1		300	2	190	400







## Use

### FISH











Subcategory	Cooking	Weight (Kg)	Function	MW (W)	Shelf	Temp. (°C)	Time (minutes)
Fish	Fresh	0.5		300	1	160	30
Fish	Frozen	0.5		300	1	160	40
Sea bass	Fresh	0.5		300	1	160	20
Monkfish	Fresh	0.5		300	1	160	35
Snapper	Fresh	1		300	1	160	40
Turbot	Fresh	0.5		300	1	160	30

### VEGETABLES

Subcategory	Cooking	Weight (Kg)	Function	MW (W)	Shelf	Temp. (°C)	Time (minutes)
Grilled vegetables	Fresh	0.5		-	3	250	25
Roasted vegetables	Fresh	1		-	2	200	45
Roast potatoes	Fresh	1		300	2	220	30
Chips	Frozen	0.5		-	2	220	13



## DESSERTS/PASTRIES

Subcategory	Cooking	Weight (Kg)	Function	MW (W)	Shelf	Temp. (°C)	Time (minutes)
Bundt cake	Fresh	1		-	1	160	60
Biscuits	Fresh	0.6		-	1	160	18
Muffins	Fresh	0.5		-	1	160	18
Profiteroles	Fresh	0.5		-	1	180	70
Meringues	Fresh	0.3		-	1	120	90
Sponge cake	Fresh	1		-	1	160	60
Strudel	Fresh	0.5		300	1	180	15
Tart	Fresh	0.8		-	1	170	40
Brioche bread	Fresh	1		-	1	180	40
Croissants	Fresh	0.6		-	1	160	30

## BREAD

Subcategory	Cooking	Weight (Kg)	Function	MW (W)	Shelf	Temp. (°C)	Time (minutes)
White leavened bread	Fresh	1		-	1	200	30
Focaccia	Fresh	0.5		-	1	190	20



## Use

### PIZZA

Subcategory	Cooking	Weight (Kg)	Function	MW (W)	Shelf	Temp. (°C)	Time (minutes)
Pan baked pizza	Fresh	1		-	1	250	9
Pizza	Frozen	0.3		-	1	250	8
Stone baked pizza	Fresh	0.5		-	1	250	6

### PASTA

Subcategory	Cooking	Weight (Kg)	Function	MW (W)	Shelf	Temp. (°C)	Time (minutes)
Pasta bake	Fresh	2		-	1	220	40
Lasagne	Fresh	2		-	1	230	35
Lasagne	Frozen	0.3		500	1	230	9
Paella	Fresh	0.5		-	1	190	25
Quiche	Fresh	1		-	1	200	40
Soufflé	Fresh	0.5		-	1	180	25

### SLOW COOKING

Subcategory	Cooking	Weight (Kg)	Function	MW (W)	Shelf	Temp. (°C)	Time (minutes)
Veal	Fresh	1		-	1	90	360
Beef	Rare	1		-	1	90	105
Beef	Well done	1		-	1	90	380
Pork loin	Fresh	1		-	1	90	330
Lamb	Fresh	1		-	1	90	360



### 3.7 Personal programs

This menu allows you to enter a personal program with the parameters you wish to use. On first use, the appliance will only offer you to add a new recipe. After storing your personal recipes, these will then be available in the relative menu.

Select the **personal programs**  icon on the "home screen".



 Up to 10 personal recipes can be stored.

### Adding a recipe

1. Select **add** from the "personal programs" menu.

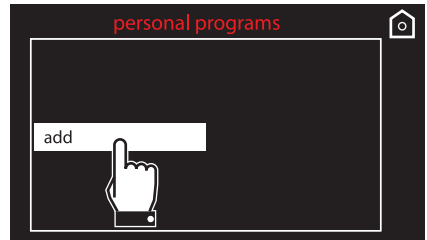

All parameters which can be changed will be highlighted in yellow on the main screen.

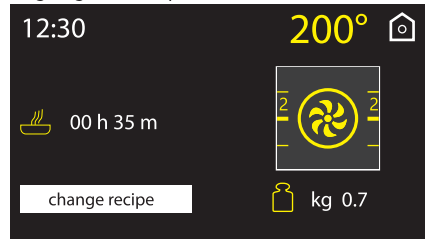

2. Press the parameter you wish to change:

- Cooking temperature

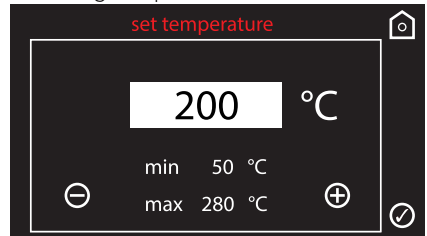



## Use

- Cooking function



- Cooking duration

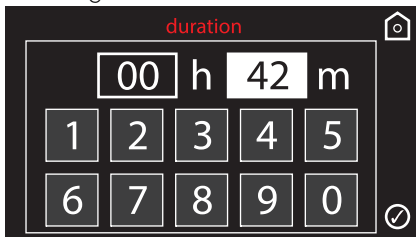

- Oven shelf

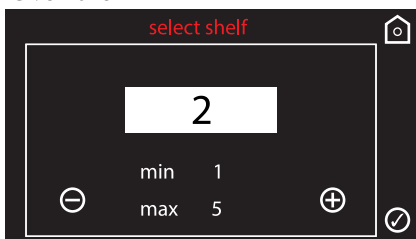

- Weight of dish



3. Make the required changes.

4. Press the symbol to store the recipe.

The appliance will ask you to enter a name for the recipe you have just created.



5. Enter the name of the recipe. The character deletes the previous letter (in the example, the recipe **recipe 1** has been stored).

The recipe name can contain maximum 10 characters, including spaces.

The name must contain at least one character in order to store the recipe.

6. After entering the name of the new recipe, press the symbol to confirm.



7. The appliance will ask to confirm the changes which have just been made. Select **yes** if you wish to store the recipe.

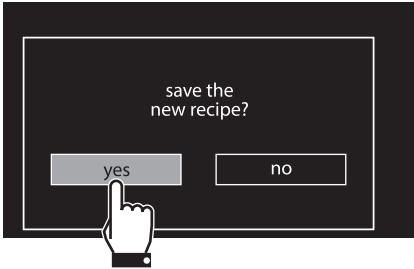

If you select **no** you will lose all changes made.

8. If saving the recipe is confirmed the display will show confirmation of this.



## Using a personal recipe

1. Select a previously saved **personal recipe** from the "personal programs" menu (in the example the recipe **recipe 1** has been saved).

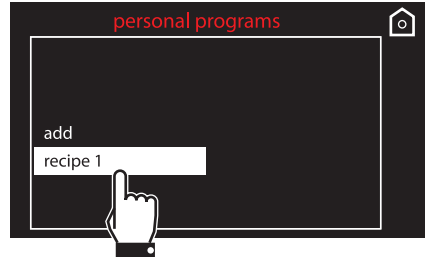

2. Select the **start** option.

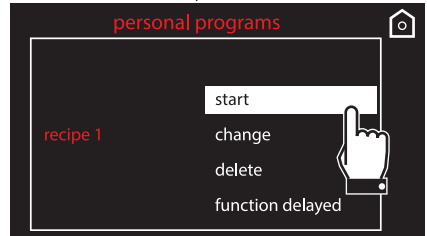

3. Cooking will start with the parameters previously set for the recipe.



During cooking it is always possible to modify the temperature and cooking time, but this will not be saved to the recipe for future use.



## Modifying a personal recipe

1. Select a previously saved **personal recipe** from the “personal programs” menu (in the example the recipe **recipe 1** has been saved).

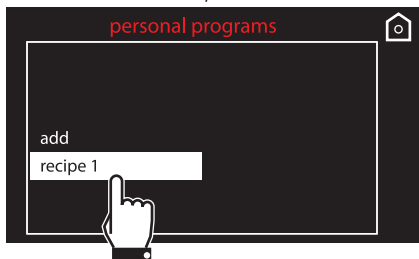

2. Select the **change** option.

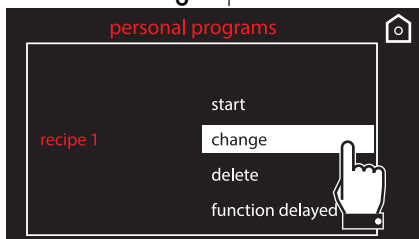

3. Repeat the same steps starting from point 2 in chapter “Adding a recipe”.

## Deleting a personal recipe

1. Select a previously saved **personal recipe** from the “personal programs” menu (in the example the recipe **recipe 1** has been saved).

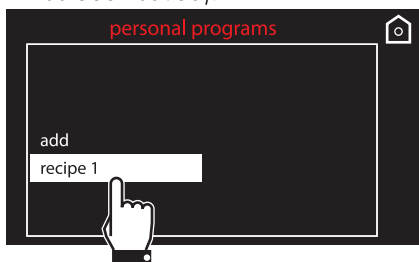

2. Select the **delete** option.

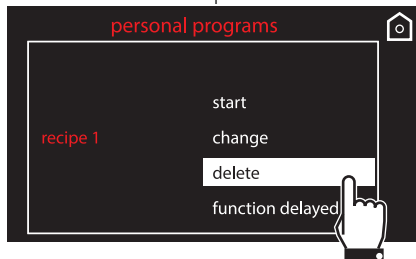

3. Confirm the deletion. Select **yes** to permanently delete the recipe.

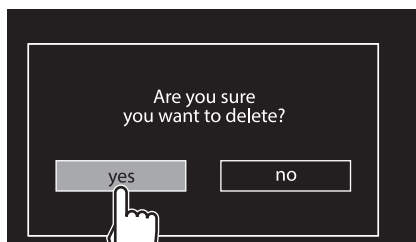

4. If you confirm the deletion, the display will show confirmation of this.







## Delay cooking

1. Select a previously saved **personal recipe** from the “personal programs” menu (in the example the recipe **recipe 1** has been saved).

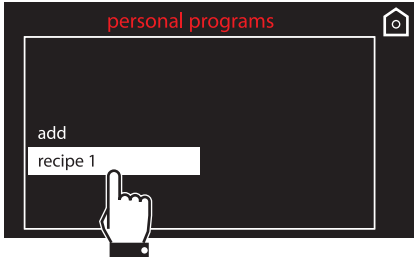

2. Select the **function delayed** option.

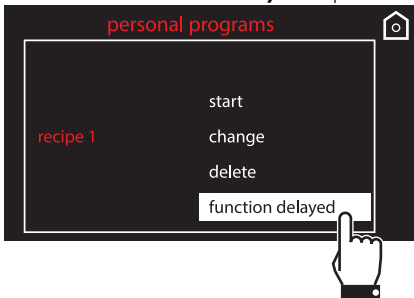

3. Enter the time at which you require cooking to end (for example at 19:30: first touch the hours box, then the numbers 1 and 9; touch the minutes box, then the numbers 3 and 0).

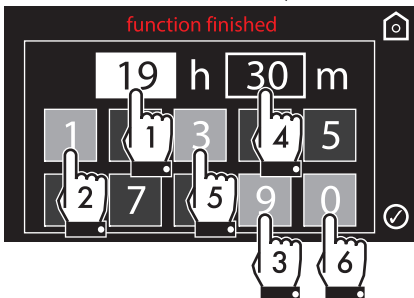

4. Press the symbol  to confirm.

5. The appliance waits for the delay start time.

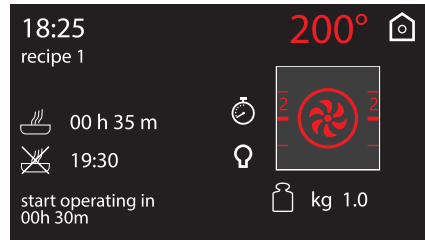

## 3.8 Settings

The product configuration can be set using this menu.

Select the **settings**  icon on the “home screen”.



In the event of a temporary power cut, all personal settings will remain stored.



# Use

## Language

**i** Sets the interface language from those available.

1. Select **language** from the “settings” menu.

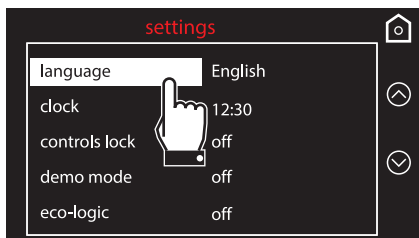

2. Press the symbols  and  to select the required language.

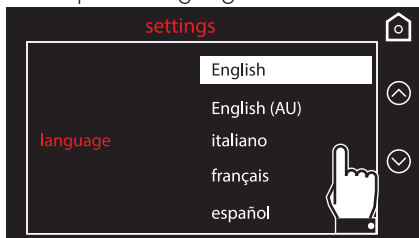

3. Confirm the selected language.

## Clock

**i** Allows you to change time displayed.

1. Press the symbol  or  and select **clock** from the “settings” menu.

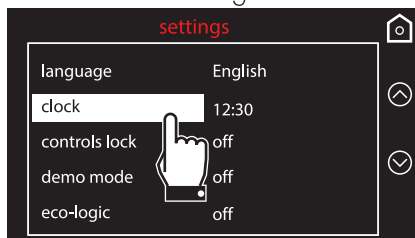

2. Enter the current time

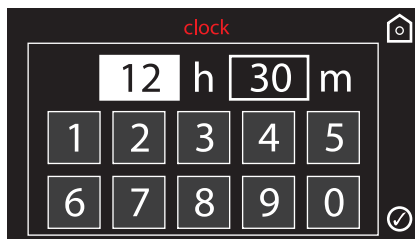

3. Press the symbol  to confirm.



## Controls lock

**i** Allows the appliance to automatically lock the controls after one minute of normal operation without any intervention from the user.

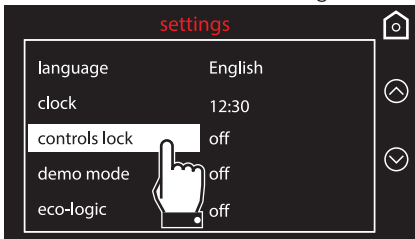

1. Press the symbol  or  and select **controls lock** from the "settings" menu.

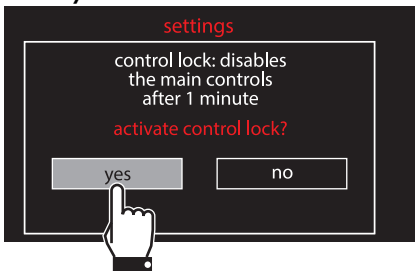

2. To confirm activation of the controls lock, select **yes**.



During normal operation it is indicated by the indicator light  coming on.

 To temporarily release the lock during cooking, press and hold the symbol  for 3 seconds. One minute after the last setting the lock will become active again.

## Demo mode (for showrooms only)

**i** This mode deactivates all the appliance's heating elements, while keeping the control panel active.

1. Press the symbol  or  and select **demo mode** from the "settings" menu.

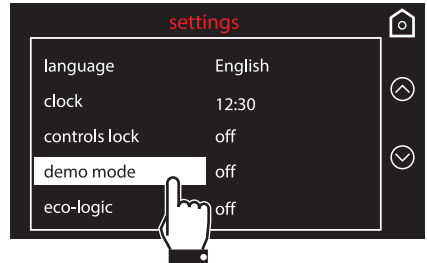

2. To confirm activation of demo mode, select **yes**.

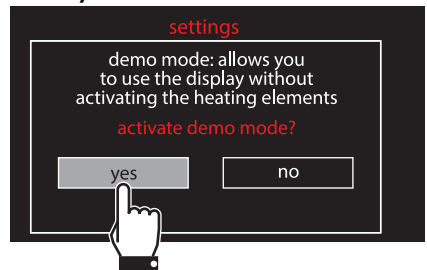

**i** If the mode is active, "demo mode" will be shown on the display.

 To use the appliance normally, set this mode to **OFF**.



# Use

## Eco-Logic

**i** This mode allows the appliance to limit the power used. Suitable for simultaneous use with further home appliances.

If this option is enabled, the symbol  will appear next to the function on the display.

1. Press the symbol  or  and select **eco-logic** from the "settings" menu.

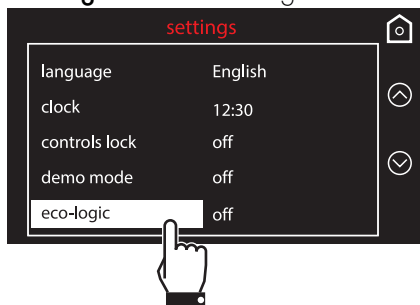

2. To confirm activation of eco-logic mode, select **yes**.

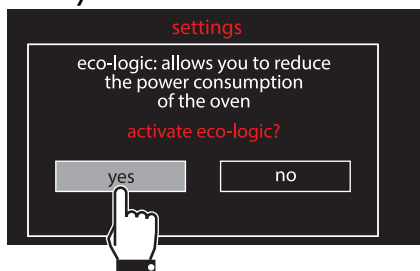

 When eco-logic mode is active, preheating and cooking times may be extended.

## Sound

**i** Whenever one of the display symbols is pressed, the appliance beeps. This setting disables these sounds.

1. Press the symbol  or  and select **sound** from the "settings" menu.

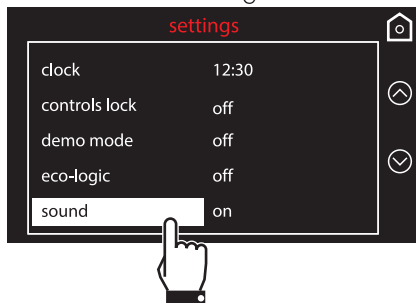

2. Select **no** to disable the sounds associated with pressing the symbols.

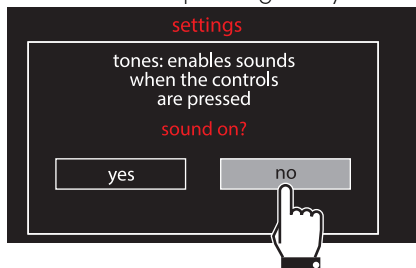



## Keep warm

**i** This mode allows the appliance to keep cooked food warm (at low temperatures) after cooking finishes with a cooking cycle for which a duration has been set (if this is not manually interrupted), without altering the taste and aromas obtained during cooking.

1. Press the symbol  or  and select **keep warm** from the "settings" menu.

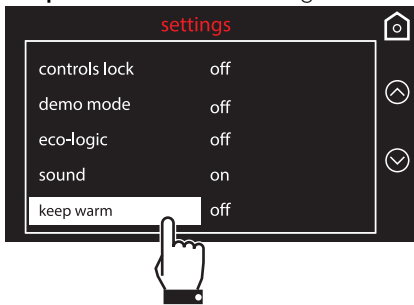

2. To confirm activation of the keep warm function, select **yes**.



**i** The keep warm function will be activated as soon as cooking is finished; this is indicated by a series of beeps (see cooking or function ended). The screen below will be shown on the display after a few minutes.



## Eco-Light

**i** For energy saving the internal lamp is switched off automatically one minute after cooking begins.

1. Press the symbol  or  and select **eco-light** from the "settings" menu.

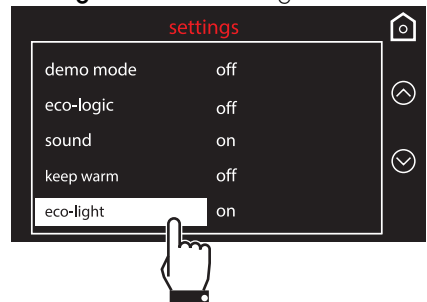



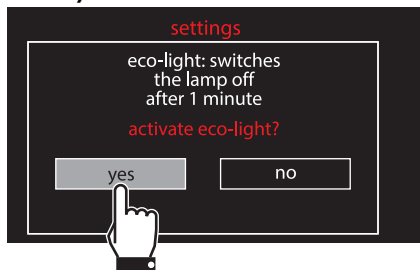

# Use

2. To confirm activation of eco-light mode, select **yes**.



To prevent the appliance from automatically turning the internal lamp off turn this mode to OFF.



The manual on/off control is always available. Press the symbol , when available, to manually activate the oven light or the symbol  to deactivate it.



The eco-light function is "on" by default (factory setting).

## Digital clock



Displays the time in digital format.

1. Press the symbol  or  and select **digital clock** from the "settings" menu.

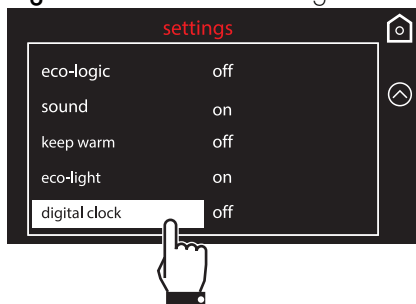

2. To confirm activation of the digital clock, select **yes**.

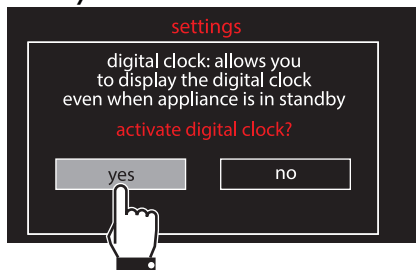

When no appliance function is active, the display will show the current time in digital format.



In the event of a temporary power cut, the digital version will remain selected.



## 4 Cleaning and maintenance

### 4.1 Instructions



High temperatures inside the oven after use  
**Danger of burns**

- Perform cleaning only after letting the appliance cool down.



Improper use  
**Risk of damage to surfaces**

- Do not use steam jets to clean the appliance.
- Do not use cleaning products containing chlorine, ammonia or bleach on steel parts or parts with metallic finishes on the surface (e.g. anodizing, nickel- or chromium-plating).
- Do not use abrasive or corrosive detergents (e.g. scouring powders, stain removers and metallic sponges) on glass parts.
- Do not use rough or abrasive materials or sharp metal scrapers.
- Failure to clean the oven could adversely affect the life of the appliance and pose a hazard.
- Always remove food residues from the oven cavity.



Improper use  
**Danger of explosion/burns**

- Do not use detergents with high alcohol content or which can release inflammable vapours. Subsequent heating could set off an explosion inside the appliance.



If a lamp is damaged, contact Technical support for a replacement. This fault will not affect the integrity of the appliance which can continue to be used.

### 4.2 Cleaning the surfaces

To keep the surfaces in good condition, they should be cleaned regularly after use. Let them cool first.

### 4.3 Ordinary daily cleaning

Always use only specific products that do not contain abrasives or chlorine-based acids.

Pour the product onto a damp cloth and wipe the surface, rinse thoroughly and dry with a soft cloth or a microfibre cloth.



## Cleaning and maintenance

### 4.4 Food stains or residues

Do not use metallic sponges or sharp scrapers as they will damage the surfaces. Use ordinary non-abrasive products with the aid of wooden or plastic utensils if necessary. Rinse thoroughly and dry with a soft cloth or a microfibre cloth.

Do not allow residues of sugary foods (such as jam) to set inside the oven. If left to set for too long, they might damage the enamel lining of the oven.

### 4.5 Drying

Cooking food generates moisture inside the appliance. This is a normal phenomenon and does not affect the appliance's operation in any way.

Each time you finish cooking:

1. Let the appliance cool down.
2. Remove any dirt from inside the appliance.
3. Dry the interior of the appliance with a soft cloth.
4. Leave the door open until the inside of the appliance has dried completely.

### 4.6 Cleaning the door glazing

The glass in the door should always be kept thoroughly clean. Use absorbent kitchen roll. In case of stubborn dirt, wash with a damp sponge and an ordinary detergent.



We recommend the use of cleaning products distributed by the manufacturer.

### 4.7 Cleaning the inside of the oven

For the best oven upkeep, clean it regularly after having allowed it to cool.

Take out all removable parts.

Clean the oven racks with warm water and non-abrasive detergent. Carefully rinse and dry damp parts.

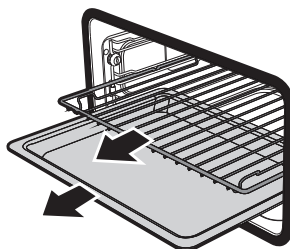

The oven should be operated at the maximum temperature for about 15-20 minutes after the use of specific products, to burn off the residues left inside the oven.





## Removing racks/trays support frames

Removing the guide frames enables the sides to be cleaned more easily. This operation should be performed each time the automatic cleaning cycle is used (on some models only).

To remove the guide frames:

1. Unscrew the two fastening pins of the frame.

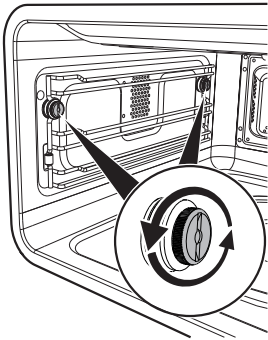

2. Pull the frame towards the inside of the oven.

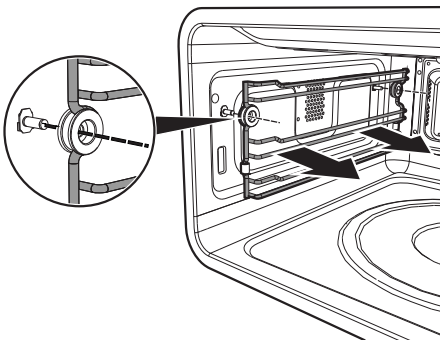

3. When cleaning is complete, repeat the above procedures to put the guide frames back in. Pay attention to the spacer bushings which need to be inserted correctly into the frames.

## Cleaning the top section

The appliance is equipped with a tilting grill element that allows for easy cleaning of the upper part of the oven cavity.

1. Free the upper heating element by gently lifting it and rotating its retaining latch by 90 degrees.

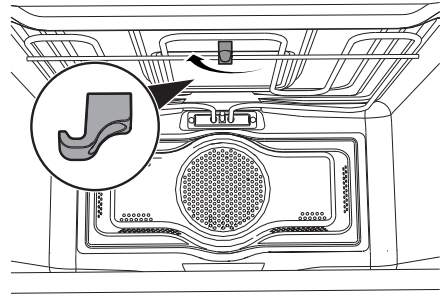

2. Gently lower the heating element until it stops.

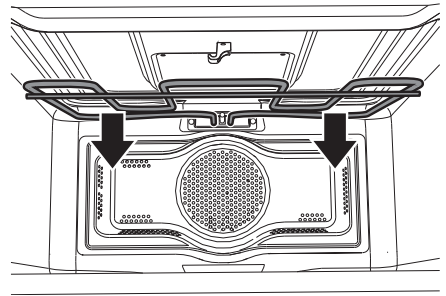

**Improper use**

**Risk of damage to the appliance**

- Do not excessively flex the element during cleaning.
3. When you have finished cleaning, place the heating element back in position and turn the retaining latch to lock it in place.



## Cleaning and maintenance

### 4.8 Vapor Clean

**i** Vapor Clean is an assisted cleaning procedure which facilitates the removal of dirt. Thanks to this process, it is possible to clean the inside of the oven very easily. The dirt residues are softened by the heat and water vapour for easier removal afterwards.

**!** **Improper use**  
**Risk of damage to surfaces**

- Remove any food residues or large spills from previous cooking operations from the inside of the oven.
- Carry out assisted oven cleaning operations only when the oven is cold.

#### Preliminary operations

Before starting the Vapor Clean function:

- Completely remove all accessories from inside the oven.
- Pour approx. 40 cc of water onto the floor of the oven. Make sure it does not overflow out of the cavity.

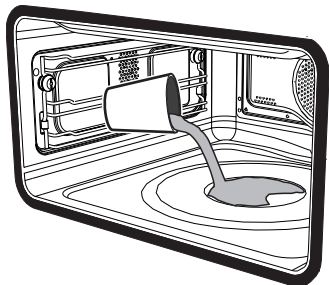

- Spray a water and washing up liquid solution inside the oven using a spray nozzle. Direct the spray against the side walls, upwards, downwards and towards the deflector.

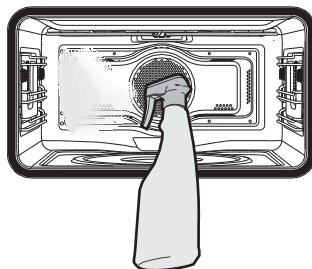

- Close the door.



We recommend spraying approx. 20 times at the most.

#### Vapor Clean setting



If the internal temperature is greater than that required for the Vapor Clean function, the cycle will be stopped immediately and "Internal temperature unsafe, please wait until the oven is cool" will appear on the display. Leave the appliance to cool down before activating the assisted cleaning cycle.

# Cleaning and maintenance



1. Select the **Vapor Clean** function from the “special functions” menu.

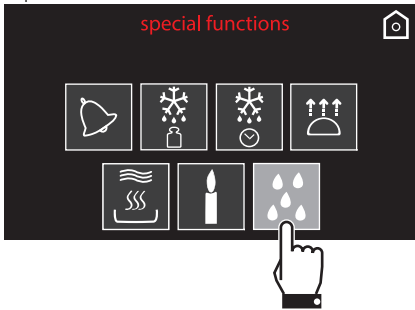

2. The duration and temperature of the cleaning cycle will appear on the display.

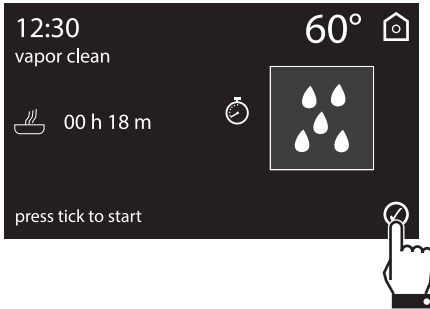

**i** The duration and temperature parameters cannot be modified by the user.

3. Press the symbol  to confirm. The assisted cleaning cycle will start.

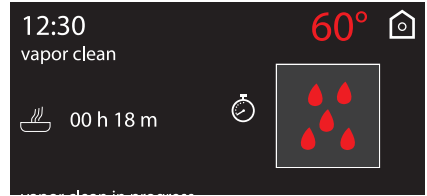

4. If the temperature inside the oven is too high, a warning buzzer and message on the display will instruct you to wait for it to cool.

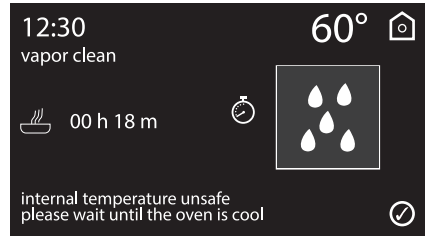

5. A buzzer will indicate the end of the Vapor Clean cycle.

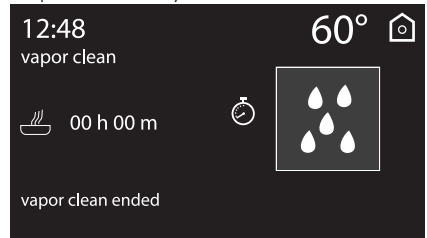

ZE



# Cleaning and maintenance

## Setting timed Vapor Clean

It is possible to program the Vapor Clean start time, like any cooking function.

1. After selecting the Vapor Clean special function, press the symbol



2. Enter the time at which you require the Vapor Clean function to end (for example at 19:30: first touch the hours box, then the numbers 1 and 9; touch the minutes box, then the numbers 3 and 0).

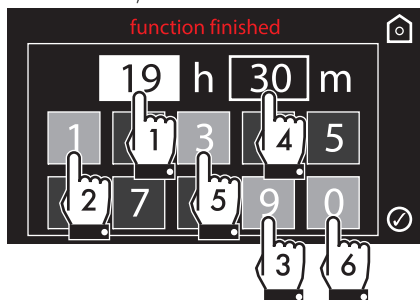

3. Press the symbol to confirm.
4. The appliance waits until the set start time to start the cleaning cycle.

## End of the Vapor Clean cycle

1. Open the door and wipe away the less stubborn dirt with a microfibre cloth.
2. Use an anti-scratch sponge with brass filaments on tougher encrustations.
3. In case of grease residues use specific oven cleaning products.
4. Remove the water left inside the oven.

For improved hygiene and to avoid food being affected by any unpleasant odours, we recommend that the oven is dried using a fan assisted function at 160°C for approximately 10 minutes.



We recommend wearing rubber gloves for these operations.



For easier manual cleaning of parts that are difficult to reach, we recommend removing the door.



## What to do if...

The display is completely off:

- Check the mains power supply.
- Check whether an omnipolar breaker on/upline of the appliance supply line is in the "ON" position.

The appliance does not heat up:

- Check whether it has been set in "demo" mode (for further details see "Demo mode (for showrooms only)").

The controls do not respond:

- Check whether it has been set in "controls lock" mode (for further details see "Controls lock").

The cooking times are longer than those indicated in the table:

- Check whether it has been set in "eco-logic" mode (for further details see "Eco-Logic").

If the door is opened during a fan assisted function, the fan stops:

- This is not a fault. It is a normal operation of the appliance, useful when cooking foods in order to avoid excessive heat escaping. When the door is closed, the oven will return to normal operation.



If the problem has not been resolved or in the case of other types of fault, contact your local technical support centre.



If other ERRx error messages are indicated:

Note down the error message, function and set temperature and contact your local technical support centre.



# Installation

## 5 Installation

### 5.1 Electrical connection



**Power voltage**  
**Danger of electrocution**

- Have the electrical connection performed by authorised technical personnel.
- The appliance must be connected to earth in compliance with electrical system safety standards.
- Disconnect the mains power supply.

### General information

Check the grid characteristics against the data indicated on the plate.

The identification plate bearing the technical data, serial number and brand name is visibly positioned on the appliance.

Do not remove this plate for any reason.

The appliance works at 220-240 V~.

Use a three-pole cable (3 x 1.5 mm<sup>2</sup> internal conductors).

Perform the ground connection using a wire that is 20 mm longer than the other wires.

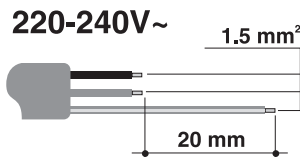

### Fixed connection

Fit the power line with an omnipolar circuit breaker in compliance with installation regulations.

The omnipolar circuit breaker should be located near the appliance and in an easily reachable position, according to applicable electrical codes.

### Connection with plug and socket

Make sure that the plug and socket are of the same type.

Avoid using adapters, gang sockets or extensions as these could cause overheating and a risk of burns.

### 5.2 Cable replacement



**Power voltage**  
**Danger of electrocution**

- Disconnect the mains power supply.

1. Unscrew the rear casing screws and remove the casing to access the terminal board.
2. Replace the cable.
3. Make sure that the cables (for the oven or any hob) follow the best route in order to avoid any contact with the appliance.



## 5.3 Positioning



**Heavy appliance**  
**Crushing hazard**

- Position the appliance into the cabinet cutout with the help of a second person.



**Pressure on the open door**  
**Risk of damage to the appliance**

- Never use the oven door to lever the appliance into place when fitting.
- Avoid exerting too much pressure on the oven door when open.



**Heat production during appliance operation**  
**Risk of fire**

- Check that the piece of furniture material is heat resistant.
- Check that the piece of furniture has the required slots.
- Do not install the appliance in a recess which can be closed with a door, or in a cupboard.

## Position of the power cable

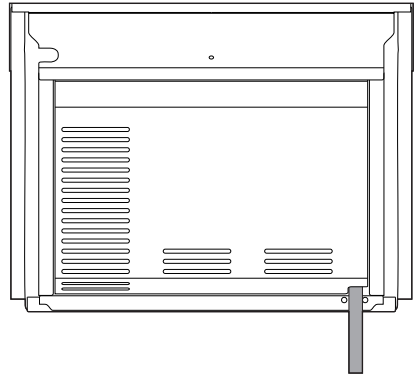

(rear view)

## Front panel seal

Glue the supplied seal to the rear part of the front panel to avoid water or other liquids from leaking in.

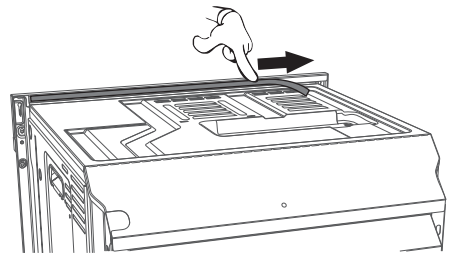



# Installation

## Fastening bushings

Remove the bushing covers inserted on the oven front.

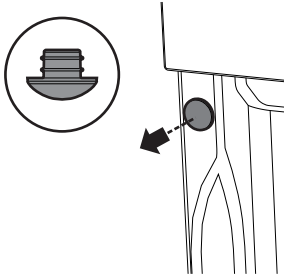

Mount the appliance into the recess.  
Secure the appliance to the piece of furniture using screws.

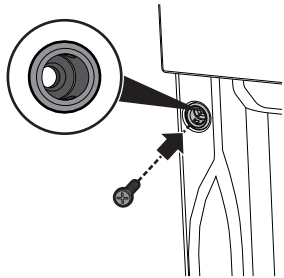

Cover the bushings with the previously removed covers.

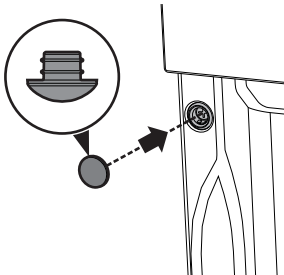

## Appliance overall dimensions (mm)

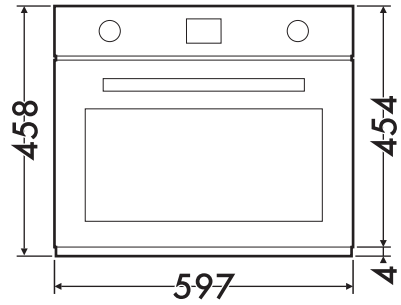

(front view)

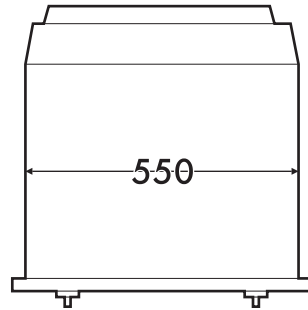

(top view)





## Mounting under worktops (mm)

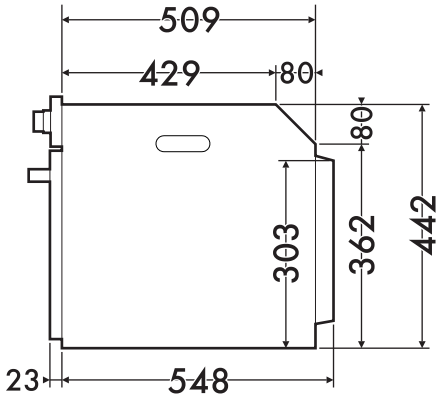

(side view)

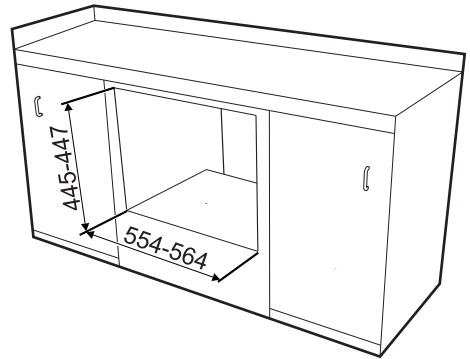
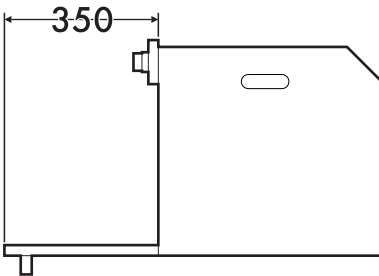
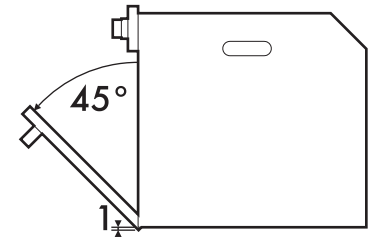

EN

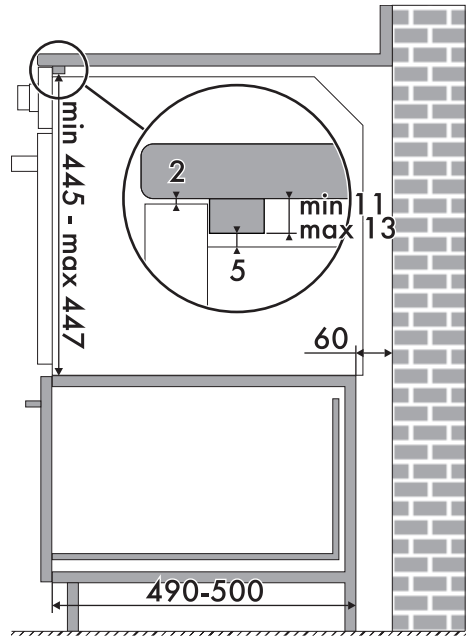

Make sure that the piece of furniture rear/bottom part has an opening of approx. 60 mm.



# Installation

## Mounting into a column (mm)

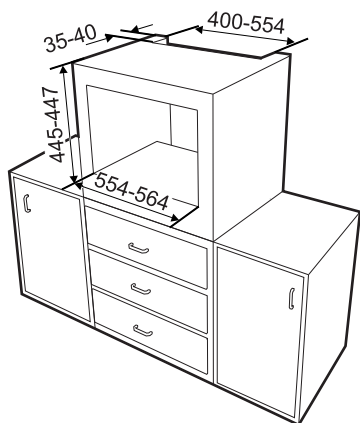

Make sure that the top/rear part of the piece of furniture has an opening approx. 35-40 mm deep.

