

| | | |
|----|-----------------------------|----|
| 1 | General safety instructions | 2 |
| 2. | Installation | 9 |
| 3. | Description of the controls | 15 |
| 4. | Operating instructions | 21 |
| 5 | Cleaning and maintenance | 22 |
| 6 | Troubleshooting | 23 |

*Thank you for choosing one of our products.
You are advised to read this manual carefully; it contains all the information you need about the right conditions for the proper, safe use of your dishwasher.*

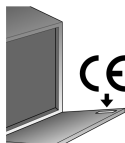

*This manual contains only the basic information required to use the appliance. The complete manual can be obtained from **www.smeg.com/download-manuals** by entering the product code shown on the plate attached to the inner right hand edge of the dishwasher door.*



The manual can be accessed quickly via the QR code using a device with a QR reader application.

TRANSLATION OF THE ORIGINAL INSTRUCTIONS

1 General safety instructions

- This manual is an integral part of the appliance; it must always be kept intact together with the dishwasher for future reference (even if sold). Before using the appliance, carefully read all the instructions contained in this manual.
- This appliance is intended for indoor use in a household environment and similar such as staff kitchens of shops, offices and other workplaces, institutions, and for the use by guests at hotels, hostels, bed and breakfast and other residential facilities. The appliance is designed and manufactured to perform the following function: **washing and drying of dishes**; any other use shall be considered improper. **The manufacturer declines all responsibility for uses other than those described above.**
- Do not use appliances which have been damaged during transit! If in doubt, contact your dealer.
- The appliance must be installed and connected in accordance with the instructions provided by the manufacturer. **Installation must be performed by qualified technicians in accordance with applicable regulations.**

-
- Never leave waste packaging unattended. Do not allow children to play with packaging materials. Separate waste packaging materials by type and consign them to the nearest recycling centre.
 - The plate with the technical data, serial number and marking is in a visible position on the inside edge of the door. **It must not be removed.**
 - The appliance must be earthed in compliance with electrical safety regulations. **The manufacturer declines all responsibility for damage to persons or property resulting from failure to earth the appliance or from a defective earth connection.**
 - During the installation the appliance must be disconnected from the network.
 - Do not install the appliance in a place subject to freezing.
 - Do not install the appliance near equipment with high irradiation temperature (e.g. gas burners, fireplaces, etc.).
 - If the appliance is installed in a compartment above or below another equipment (e.g. gas burners, ovens, etc.), read carefully the instructions provided by the manufacturer of the equipment. If the instructions of the equipment do not contain information, contact the manufacturer of the equipment to ensure that the appliance can be installed above or below it.

-
- Building-in the appliance underneath a hob is absolutely forbidden. Installing a hob on top of free-standing appliance is absolutely forbidden.
 - To ensure stability, install the appliance only under continuous worktop, securely fixed to adjacent cabinets. If the appliance is installed in a high cabinet, both the appliance and the cabinet must be adequately fixed.
 - If the appliance is not built-in and is therefore accessible on one side, the door hinge area must be covered for safety reason (injury hazard). The covering fixtures are available as an accessory from specialist dealers or the after-sales.
 - Check that the voltage and the frequency of the mains match the ratings on the name plate of the appliance.
 - The plug on the supply cord and the corresponding socket outlet must be of the same type and meet the regulations in force. Do not use adaptors or shunt connections in order to avoid the possibility of overheating or burning.
 - The plug of the appliance must be accessible after installation. Never disconnect the plug by pulling on the power supply lead.
 - If the appliance is provided with a plugless supply cord, an omnipolar circuit breaker providing a full disconnection in overvoltage protection class III must be installed in an easily accessible position on the supply line.

-
- The appliance **must** be connected to the water supply by means of new hoses.
 - Briefly test the appliance after installation. Run a wash cycle with a temperature of between 45 and 70°C with the dishwasher empty and using a specific dishwasher detergent. (It is not sufficient to run a soak cycle). If the dishwasher fails to operate correctly, disconnect it from the electrical power supply and call the nearest technical service centre.
Never attempt to repair the appliance yourself.
 - The dishwasher should only be used by adults. Use by children aged from eight years and persons with reduced physical, sensor or mental capabilities or lack of experience and knowledge is only permitted under the supervision of a person responsible for their safety.
 - I Do not allow children to play with the appliance.
 - Keep children away from the dishwasher when the door is open. Always check that the detergent distributor is empty after completion of the wash cycle.
 - Cleaning and regular maintenance of the appliance by children is only permitted under the supervision of a person responsible for their safety.
 - Some detergents are strongly alkaline. Avoid contact with the skin and eyes. Detergents can be extremely dangerous if swallowed. They contain substances capable of causing permanent damage to the mouth and throat, and even leading to

suffocation. Observe all the safety instructions on the packaging of these products.

- Do not drink the water residues which may be present on the dishes or appliance at the end of the washing program.
- Never place solvents such as alcohol or turpentine, which are potentially explosive, inside the appliance. Never load dishes soiled with ash, wax or paint.
- Never leave the dishwasher door open; people might trip over it. Leaning or sitting on the dishwasher door when open may cause the appliance to overturn and/or damage it.
- Switch off the dishwasher after use to avoid wasting electricity.
- Knives and other kitchen equipment with sharp edges must be placed in the basket with their tips downwards, or horizontally in the top basket; take care not to injure yourself on any sharp edges protruding from the baskets.
- The appliance satisfies all applicable safety regulations governing electrical equipment. Any technical checks should be conducted exclusively by trained and authorised technicians: **repairs performed by unauthorised persons not only void the warranty but may also put the user's safety at risk.**
- In the event of a fault, disconnect the dishwasher from the electrical power supply and shut off the water tap. In the event of damage to the supply cord,

have it replaced by the manufacturer or an authorised technical service centre.

- Some components are live even with the **on/off** button in the off position. Before performing any maintenance work on the appliance, disconnect it from the electrical power supply.
- Do not clean the machine with a water jet machine, high-pressure or steam cleaners.
- **Models with “acquastop” device**

This device prevents flooding in case of water leak. When the “acquastop” device is tripped, contact a qualified technician to identify and repair the fault.

In these models the water intake hose contains a solenoid valve. **Do not cut the hose and do not allow the solenoid valve to drop into water.** In case of damage to the water intake hose, disconnect the appliance from the electrical and water supply.

Warning: The device only works if the dishwasher is connected to the mains.

1.1 Declaration of conformity

The appliance complies with the essential requirements of the following European directives:

- 2009/125/EC
- 2011/65/EU
- 2014/35/EU
- IEC/EN 62471, risk group 1, for models with internal lighting.
- IEC/EN 61770

1.2 Disposal



This appliance must be disposed of separately from other waste (directives 2012/19/EC).

The appliance does not contain substances in quantities sufficient to be considered hazardous to health and the environment, in accordance with current European directives:

To dispose of the appliance:

- Cut the power cable,
- make the lock unusable.

The manufacturer declines any liability for damage or injury caused by failure to comply with the instructions indicated above or as a result of tampering with even just one part of the appliance and the use of non-original spare parts.



2. Installation

2.1 Technical characteristics

| | |
|---|--|
| Water supply pressure | min. 0,05 - max. 0,9 MPa (min. 0.5 – max. 9 bar) |
| Water supply temperature | max. 60°C |
| Capacity | 12-13 standard place settings |
| Class of protection against moisture | IPX0 |
| Protection against electric shock | class I |
| Electrical data | see the data plate |

Appliance dimensions (mm)

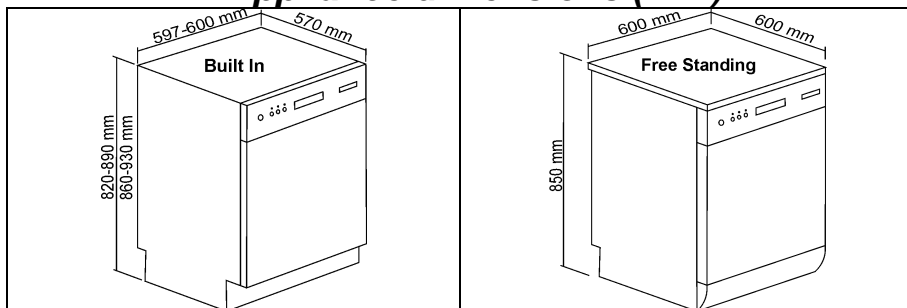



2.2 General Information

- This appliance may be placed up against walls or other furniture units.
- If the appliance is installed near a heat source, fit a special insulating panel to prevent overheating and malfunction of the appliance.
- To facilitate the installation procedure, the intake and drain hoses can be positioned in any direction; make sure that the hoses are not kinked, crushed or pulled too tightly.
- A hole at least 8 cm in diameter is required to allow the power supply cable and hoses to pass.
- At the end of the installation, perform a short test of the appliance: open the water tap and check that there are no leaks.
- To install the dishwasher against the back wall, the hoses should be passed through the lower area where there is a dedicated space for them.



Level the appliance on the floor using the appropriate Allen key to regulate the adjustable feet. This operation is essential for ensuring correct operation of the dishwasher.



Some models are equipped with only one adjustable foot at the rear, which can be adjusted by turning the screw on the lower front part of the appliance.



Building-in a dishwasher underneath a hob is **absolutely forbidden**.

Moreover, dishwashers **may not** be installed directly touching appliances which are **not conventional** built-in kitchen appliances (e.g. fireplaces, stoves, etc.).



When installing the dishwasher in a compartment next to one or more other appliances, it is essential to comply with all the recommendations provided by the appliance's manufacturer (minimum distances, installation procedures, etc.).

For free-standing models only

- Installing a hob on top of a free-standing dishwasher is **absolutely forbidden**.

- If the appliance is accessible from one side, the door hinge area has to be covered for safety reasons (risk of injury). The covers are available as an accessory and can be ordered through the Technical Assistance Service.



- The top surface of the dishwashers can be removed to allow installation under a worktop.

The **appropriate kit** should be purchased from authorised dealers or via the Technical Assistance Service.

This must be carried out by authorised personnel.



2.3 Water supply connection

CONNECTING TO THE WATER SUPPLY

Connect the intake hose to a cold water supply with $\frac{3}{4}$ " gas thread, inserting the filter **A** supplied with the dishwasher. **Take care to screw the hose firmly into place with your hands and then complete by tightening about $\frac{1}{4}$ of a turn with pliers.**

In dishwashers equipped with the AQUASTOP device, the filters is already fitted inside the threaded ring.

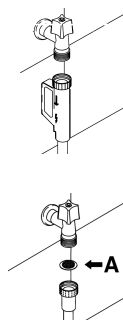

The dishwasher can also be connected to a hot water supply **not exceeding 60°C**. Supplying the appliance with hot water cuts down the washing time by approximately 20 minutes, but slightly reduces its effectiveness. Make the connection to the domestic hot water supply using the same procedure described for connecting to the cold water supply.

Supplementary note regarding the water connection, for the German market:

Before connecting the product to the water supply, make sure that the water system has been fitted with a safety device to protect drinking water against contamination due to backflow (according to DIN EN 1717). The water valves and/or taps are fitted with these safety devices if the water system of the house has been properly implemented.



DRAIN CONNECTION

Insert the dishwasher's drain hose into a drain pipe having a diameter of at least **4 cm**, or alternatively, place it inside the kitchen sink using the plastic support provided, taking care not to crush or excessively bend the hose. It is important to prevent the hose from coming loose and falling. For this purpose, the plastic support is equipped with a hole for tying it to the wall or water tap.

The free end should be positioned at a height of between **30 and 100 cm**, and should never be submerged in water.

If a horizontal drain extension hose is used (for a maximum 3 m), the drain hose can be placed at a maximum height of **85 cm** from the ground.

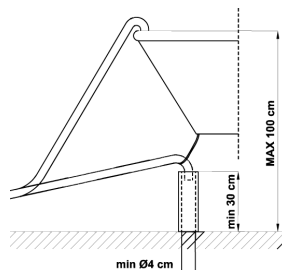



2.4 Electrical connection



Check that the voltage and the frequency of the mains match the ratings on the name plate of the appliance positioned on the inner edge of the door.

- The plug on the supply cord and the corresponding socket outlet must be of the same type and meet the regulations in force.
- The plug must be accessible after installation.
- **Never disconnect the plug by pulling on the power supply lead.**
- After changing the supply cord, make sure that the bracket which secures the cord is fixed securely in place.
- **Do not use adaptors or shunt connections** in order to avoid the possibility of overheating or burning.



The power cable must be replaced by the manufacturer or by an Authorized Service Centre.



3. Description of the controls

3.1 Front panel

All the dishwasher controls are grouped on the front panel. Programming and option selection are only possible with the **door closed**.

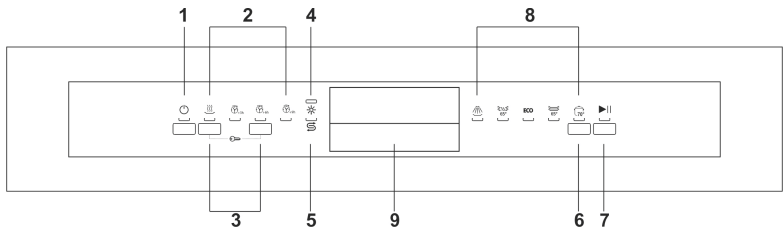

| | |
|---|--|
| 1 | ON/OFF BUTTON AND WARNING LIGHT |
| 2 | OPTION SELECTION BUTTONS AND WARNING LIGHTS |
| 3 | “CHILD LOCK” ACTIVATION BUTTONS |
| 4 | NO RINSE AID LIGHT (some models only) |
| 5 | SALT WARNIN LIGHT (on some models only) |
| 6 | PROGRAM SELECTION BUTTONS |
| 7 | START/PAUSE BUTTON |
| 8 | PROGRAM INDICATOR LIGHTS |
| 9 | HANDLE TO OPEN THE DOOR |

N.B.: symbols and styling are guideline and may vary depending on the model or version of the dishwasher purchased.



SWITCHING ON

When the **ON/OFF** button (1) is pressed, the dishwasher switches on. The indicator lights will display the dishwasher's "status".

PROGRAMMING

Programming operations are only possible with the **door closed**. As long as the door is open, the **PROGRAMS (8)** lights remain off.

PROGRAM SELECTION

Press the **PROGRAM SELECTION** button (6) several times until the light of the program required comes on.

STARTING THE PROGRAM



To start the dishwasher, press the **START/PAUSE** button (7) for a few seconds, until the light of the selected program starts to flash (confirmation beep).

The light will flash as long as the program is in progress, to indicate that it is being performed.

END OF PROGRAM

At the end of the program the beeper sounds briefly and the program **lights 4 and 5** (marked "end") flash.





INTERRUPTION A PROGRAM

To interrupt a program in progress:

- press the **START/PAUSE** button **(7)**; the light of the program in progress remains on (confirmation beep);
- you may now restart the program by pressing button **(7)** again until it restarts, or change or annul the program (see "**CHANGING A PROGRAM**", or "**ANNULLING A PROGRAM**").

CHANGING A PROGRAM

To change the running program it is necessary:

- to interrupt the running program (see "**INTERRUPTION A PROGRAM**");
- select the new program;
- start the program (see "**STARTING THE PROGRAM**").

ANNULLING A PROGRAM

To annul the program, keep the **START/PAUSE** button **(7)** pressed until the program is interrupted (light on and confirmation beep).

Press button **(7)** again and keep it pressed until the

lights 4 and 5 (marked "end") come on. ■-END-■









The water in the tank will be pumped out and the program will end at the point where it was interrupted.



*In case that the door is opened during the operation, to the next door closing it is going to be necessary to start the program as shown in paragraph "**STARTING THE PROGRAM**". The program will resume from the point in which it was interrupted.*

In case that the tub temperature is higher than 50°C the program will start about 60 seconds later.



| PROGRAMS TABLE | | | | | | | | | |
|----------------|--|----------|------|--------|------|--------|--------------------|----------------------------------|------------------------------------|
| Program | | Pre-wash | Wash | Rinse | | Drying | (1) Duration (min) | Water consumption (liters/cycle) | (1) Energy consumption (KWh/cycle) |
| P1 | SOAK  | cold | - | - | - | - | 15 | 3,8 | 0,02 |
| P2 (**) | ½ LOAD  65° | - | 65°C | cold | 70°C | • | 130 | 10,6 | 1,20 |
| P3 (*)(**) | ECO  | - | 48°C | cold | 41° | • | 265 | 9 | 0,734 |
| P4 (**) | MIX 65° 65°  | cold | 65°C | cold | 55°C | • | 150 | 12,5 | 1,35 |
| P5 | INTENSIVE 70°  | hot | 70°C | 2 cold | 70°C | • | 155 | 15,5 | 1,60 |
| P6 | EXPRESS 27'  P1+S | - | 38°C | - | 50°C | - | 27 | 6,7 | 0,70 |
| P7 (**) | CRYSTAL 45°  P2+S | - | 45°C | 2 cold | 55°C | • | 125 | 12,4 | 1,15 |
| P8 (**) | SILENT  P3+S | - | 55°C | cold | 55°C | • | 270 | 9,6 | 1,25 |
| P9 | FULL EXPRESS 60' 60 min P4+S | - | 65°C | cold | 70°C | • | 60 | 9,6 | 1,40 |
| P10 | HYGIENE 99,9%  P5+S | hot | 70°C | 2 cold | 75°C | • | 130 | 15,4 | 1,20 |



Automatic door opening – Dry Assist

Automatic door opening is **included** in programs indicated with ** in the first column.



There must be sufficient space available for the door to open. The door must not be forced open and closed before the wash cycle has ended completely.

(*) Standard program according to **EN 60436**.

(1) Consumption and program duration are measured according to EN 60436. The values may vary due to various factors, such as the inlet water temperature and the number of dishes.

AUTOMATIC DOOR OPENING – DRY ASSIST

(always included in the ECO program)

The program ends with a drying cycle that consists of a time during which the door is closed, and a time during which the door is slightly open (just waiting, to assist drying). The duration depends on the program and model.

Any intervention (opening / closing the door, switching off etc.) during this stage will end the program early.

The program can be interrupted during the drying cycle and the dishwasher can unloaded before the cycle has completely ended, which is indicated by a visual and/or audible alarm (depending on the model), but best drying results may not be obtained.

The complete program ends only when indicated by a visual and/or audible signal (depending on the model).

NOTE: The Hygiene 99.9% program has been tested by an external laboratory (VDE) without an option selected.

In order to be effective, the cycle should not be interrupted.

Notice for testing institutes

Testing institutes are provided with guidelines for comparative tests (e.g. according to EN60436). request the guidelines by contacting us at the following

e-mail address: dishwasher@test-domestic-appliances.com

When making a request, please specify the model (MOD) and the serial number (S/N) indicated on the plate on the side of the door.

| OPTIONS TABLE | | |
|----------------|--|---|
| Option | | Description |
| SPECIAL | | Creates additional programs. “SPECIAL” programs are indicated by the light. |
| DELAY | | Allows the wash cycles 1 or 3 to be delayed by up to 9, 12 or 24 hours depending on the models. |



Description of the programs:

SOAK

Rinses dishes while waiting to be washed.

½ LOAD

To wash just a few normally soiled dishes, washed immediately after use

ECO

Cycle with the lowest water and energy consumption, recommended for normally soiled dishes, even with dried-on residues.

MIX 65°

Normally soiled mixed loads such as dishes and pans, even with dried-on residues.

INTENSE 70°

Heavily soiled plates, pots and pans, even with dried-on residues.

EXPRESS 27'

Quick cycle for lightly soiled dishes, washed immediately after use.

CRYSTAL 45°

Wine glasses and lightly soiled fine china. Ideal when you require dazzlingly clean glassware.

SILENT

Normally soiled dishes, even with dried-on residues. Ideal if you wish to run it during the night.

FULL EXPRESS 60'

Quick cycle for normally soiled mixed loads such as dishes and pans, even with dried-on residues. Dishes are washed and dried in 60 minutes.

HYGIENE 99,9%

Intensive wash cycle for plates, pots, pans, cutting boards, feeding bottles. Ideal for baby dishes or if there are allergy sufferers in the family.



“CHILD LOCK” OPTION

By pressing the indicated buttons **(3)** at the same time, the controls are locked, which is confirmed by the flashing **ON/OFF (1)** warning light. This option stays active (and the warning light keeps flashing) until the buttons **(3)** are pressed again.

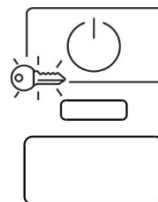
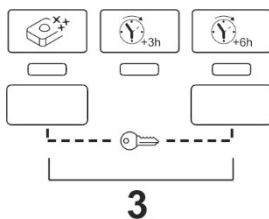



4. Operating instructions

After having installed the dishwasher, remove the basket retainers.

4.1 Adding the salt

The salt prevents the formation of scale deposits.

- Unscrew the cap of the salt container.
- Only for the first time, fill the container with a litre of water.
- Pour salt (approx. 1 kg) into the container using the funnel provided with the dishwasher.
- Remove any salt residues before screwing the cap back on.

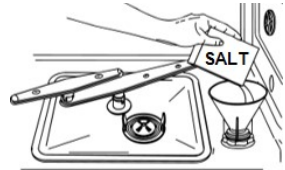

To regulate the water hardness setting, please refer to the complete manual that can be found on the website.



- *Only use regeneration salt specifically for domestic dishwashers.*
- *After having added the salt, run a wash cycle to remove any excess salt.*

4.2 Adding the rinse aid

The rinse aid helps to dry the dishes more quickly.

To add rinse aid:

- Open the dispenser by pressing and lifting the tab on the cover.
- Top up again when the rinse aid indicator light turns on.
- Close the cover, a click indicates when it is closed.
- Use a cloth to remove any spillage of rinse aid which might lead to the formation of excess foam.

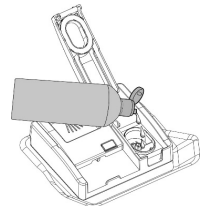

To regulate the amount of rinse aid, please refer to the complete manual that can be found on the website.

4.3 Adding the detergent

- Open the detergent dispenser cover by lightly pressing the button **P**.
- Add the detergent or tablet.
Close the cover by sliding it until it stops, indicated by a click.

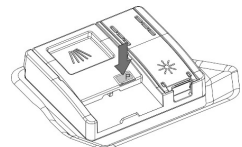



5 Cleaning and maintenance



Before carrying out any work, always unplug the appliance from the electrical supply or switch off the omnipolar circuit breaker.

CLEANING THE WATER INTAKE FILTER

Close the water supply tap, unscrew the end of the water intake hose, remove the filter **A** and clean it under running water. Put the filter **A** back into its seat and carefully screw the water intake hose back on.

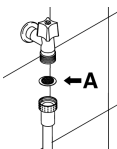

CLEANING THE SPRAY ARMS

Remove the spray arms and wash them with a jet of water. Put them back in their seats, **making sure that there is nothing to prevent them from rotating.**

- To remove the **upper** spray arm, unscrew locking ring **R**.
- To remove the **lower** spray arm, simply lift it up, pulling by the central part. To remove the **orbital** spray arm assembly, take hold of the longer arm and pull the orbital unit upward.
- To remove and clean the **planetarium** sprayer follow the instructions provided.

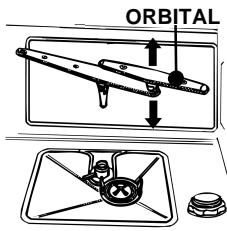
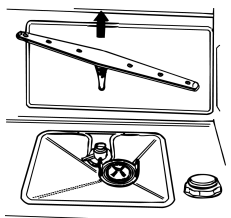
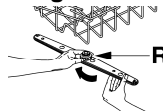

PLANETARIUM

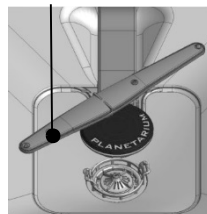

CLEANING THE FILTER UNIT



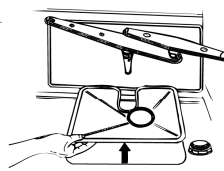
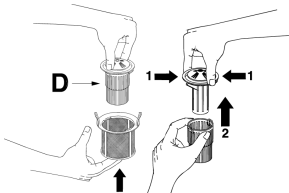

- Remove the planetarium spray arm (only for the models on which it is fitted)
- Grip the tabs, turn them anticlockwise and lift upwards.
- Push the central filter **D** from underneath to remove it from the micro-filter.
- Separate the two parts that make up the plastic filter by pressing the body of the filter in the zone indicated by the arrows.



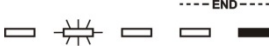

6 Troubleshooting

The dishwasher is equipped with a self-diagnostics system that is capable of detecting and signalling a number of possible faults.

| | FAULT | DESCRIPTION |
|----|---|--|
| E1 |  | Acquastop failure The anti-flooding system has been activated (for the relevant models only). The system is tripped in case of water leaks. Contact the after-sales service. |
| E2 |  | Safety level The system which limits the water level inside the dishwasher has been tripped. Interrupt the program and switch off the dishwasher. Switch the dishwasher back on, program it again and start the washing cycle. If the problem persists, contact the after-sales service. |
| E3 |  | Water heating malfunction The water is not heated or the heating parameters are not correct. Repeat the washing program; if the problem persists, contact the after-sales service. |
| E4 |  | Water temperature monitoring malfunction Interrupt the program and switch off the dishwasher. Switch the dishwasher back on, program it again and start the washing cycle. If the problem persists, contact the after-sales service. |
| E5 |  | Water intake malfunction The appliance does not take in water or does not do so correctly. Check that the water connections are correct, the water intake tap is turned on and the filter is not fouled. If the problem persists, contact the after-sales service. |
| E6 |  | Water pump-out malfunction The appliance does not pump out the water or does not do so correctly. Check that the drain hose is not kinked or crushed and that the siphon and filter are not fouled. If the problem persists, contact the after-sales service. |



| | FAULT | DESCRIPTION |
|------------|-------|---|
| E7 | | <p>Turbine flow-regulator malfunction (for the relevant models only) The appliance is not able to "measure" the amount of water loaded accurately. Interrupt the program and switch off the dishwasher. Switch the dishwasher back on, program it again and start the washing cycle. If the problem persists, contact the after-sales service.</p> |
| E8 | | <p>Alternate washing system malfunction Interrupt the program and switch off the dishwasher. Switch the dishwasher back on, program it again and start the washing cycle. If the problem persists, contact the after-sales service.</p> |
| E9 | | <p>Water intake system malfunction Contact the after-sales service.</p> |
| E11 | | <p>Wash motor pump does not work</p> |

 Light off

 Light on

 Light flashing

If an alarm occurs the appliance interrupts the program in progress and signals a fault.

- Alarms **E1**, **E2**, **E3**, **E4**, **E8** and **E9** interrupt the current program immediately.
- The **E5**, **E6** alarms interrupts the running program once the cause is resolved, it will bring back the execution of the program.
- The alarm **E7** is visualized at the end of the cycle that comes, however, brought to the end since the operation of the dishwasher is not harmed.
- **E11**: Contact the after-sales service.

To "reset" an alarm is necessary:

Open and close the door, or turn off and on the machine. At this point is possible to program the dishwasher again.



If the malfunction persists, contact your authorised Service Centre.